

MONTAJ VE KULLANIM KILAVUZU

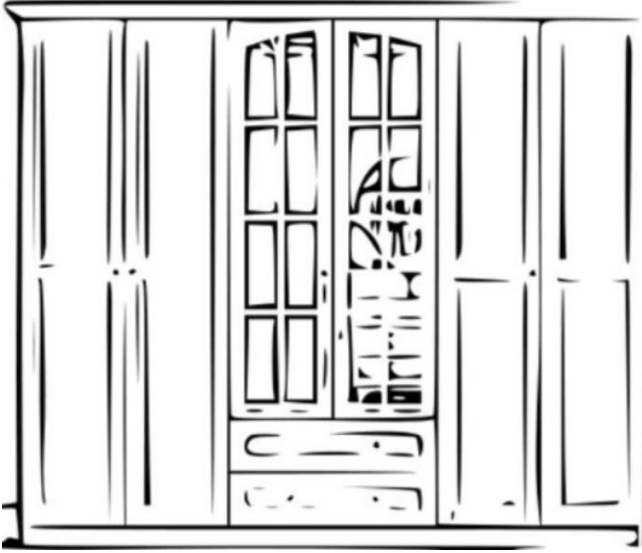

İletişim Bilgileri;

Telefon: 0332 502 00 36

E-mail: bilgi@rabimobilya.com.tr

Sevgili Müşterimiz,

Tüm ürünlerimiz, tasarım sürecinden üretim ve teslimat sürecine kadar her adımında, sizin ürünlerden keyif almanız ve uzun yıllar sağlam bir şekilde kullanmanız için kontrol ve testlerden geçirilmiştir.

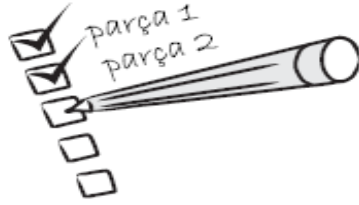

Montaja başlamadan önce tüm parçaları kutu içerisinden çıkararak montaj kılavuzuna göre kontrol ediniz. Eğer birden fazla ürün aldıysanız, parçaların aksesuarları karışmaması için ürünlerin kurma işlemini sırası ile yapınız.

Montaja başlamadan önce her parçayı nemli bir bez ile temizleyiniz. Ürünün genel kullanımında da bu temizlik yeterli olacaktır.



Ürünler özenle kontrol edilmesine ve paketlenmesine rağmen kargo esnasında bir problem ile karşılaşmanız durumunda, gerekli parçaları kontrol ederek bir sorun olduğunda bilgi@rabi.com.tr adresine e-posta atabilir veya sitemizdeki iletişim numaralarından bize ulaşabilirsiniz. Oluşan sorun, mümkün olan en kısa zamanda bedelsiz olarak giderilecektir.

Mobilyanızı amacı dışında kullanmayınız. Farklı kullanım amacı düşünüldüğünde lütfen tarafımız ile iletişime geçiniz. Mobilyalar direkt olarak soğuk, sıcak veya nem ile temas ettiklerinde zarar görebilmektedir. Bu nedenle mobilyanızın direkt olarak bu faktörler ile temasını engelleyiniz.

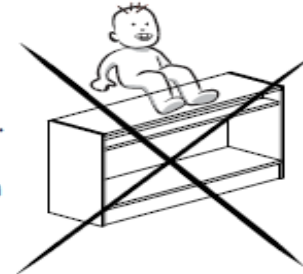



Sabit Raf

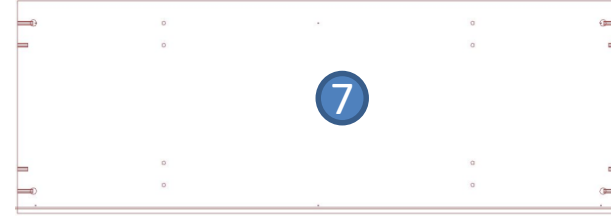

Alt ve Üst Dikme

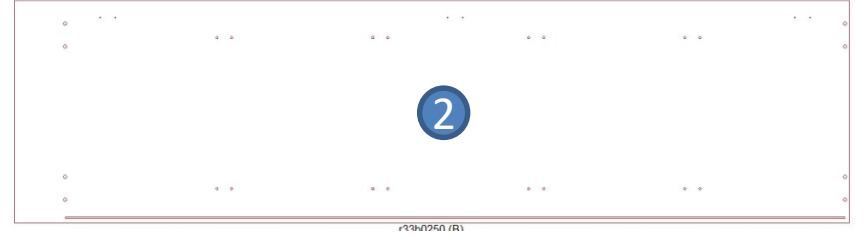
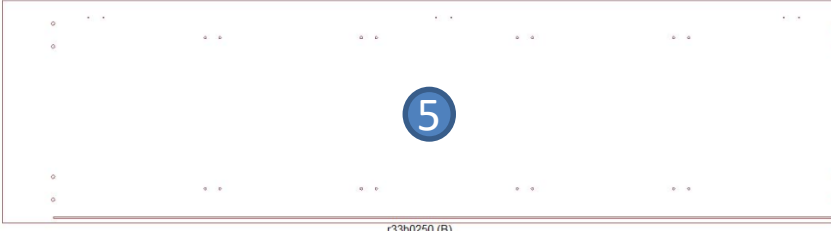

Sağ ve Sol Dikme

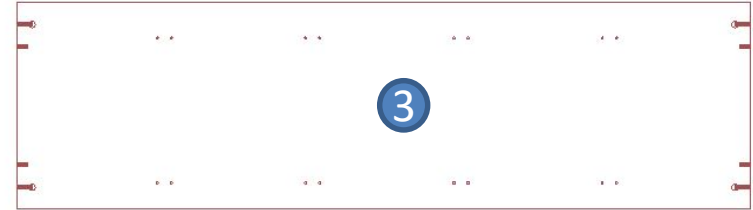

Orta Dikme

AKSESUAR LİSTESİ



DEVE MENTEŞE



DÜZ MENTEŞE



FLANŞ



BORU



RAF PİMİ



MINİFIX GÖVDE



CAM TIRNAĞI



KAVELA



MINİFIX VİDA



RAY TAKIMI



KULP VİDASI



ÇEKMECE VİDASI

HIRDAVAT LİSTESİ

YARDIMCI EKİPMAN



Lütfen montaj esnasında
Yardımcı bulundurunuz !

AKSESUARLAR	6 KAPAK 2 ÇEKMECE	4 KAPAK 2 ÇEKMECE	4 KAPAK	3 KAPAK 2 ÇEKMECE
MINİFIX GÖVDE	30	20	20	16
MINİFIX VİDA	30	20	20	16
RAY TAKIMI	2	2	-----	2
FLANŞ	6	2	4	2
ASKI BORUSU	3	1	2	1
RAF PİMİ	12	36	16	20
KULP VİDASI	6	8	8	3
ÇEKMECE VİDASI	4	4	-----	4
3,5*50 VİDA	24	4	6	24
KAVELA	30	20	20	16
DÜZ MENTEŞE	6	6	6	5
YARIM DEVE MENTEŞE	10	4	6	2
3,5*18 VİDA	90	60	60	55
3,5*30 VİDA	12	22	-----	4
CAM TIRNAĞI (AYNALI MODELLER İÇİN)	12	12	12	12

**Baza ve alt tabla
birleştirme**

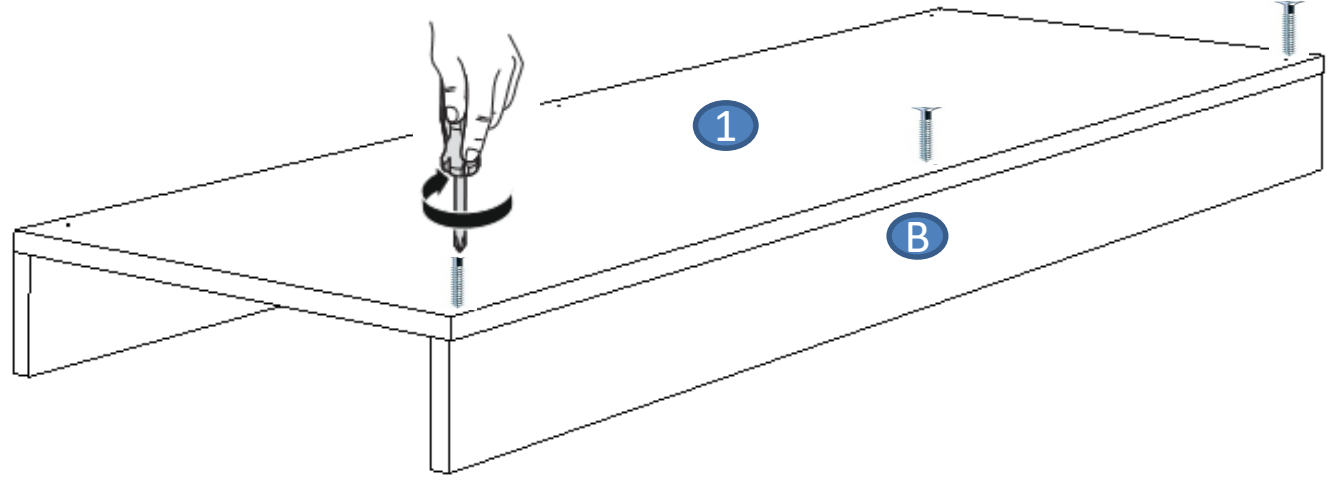

**Sağ ve Sol Dikme
birleştirme**

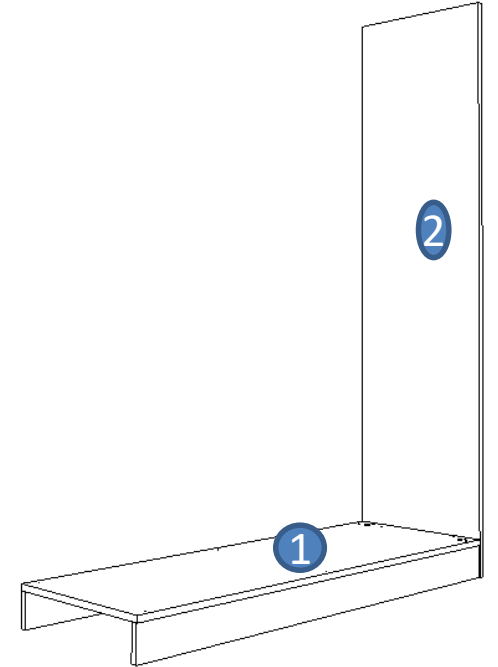
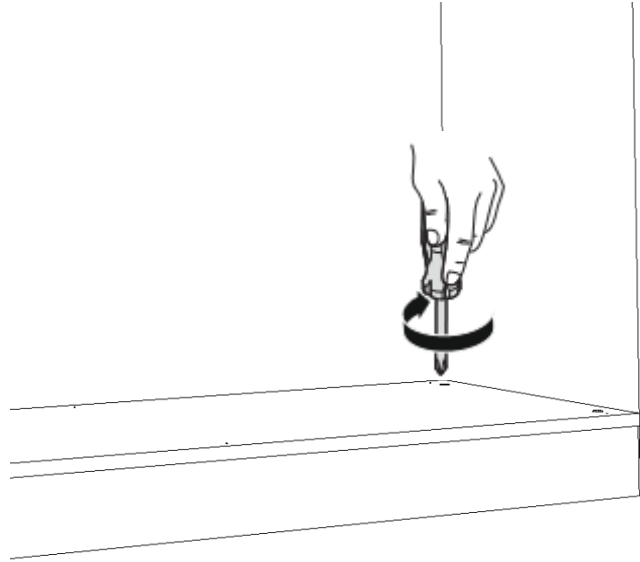
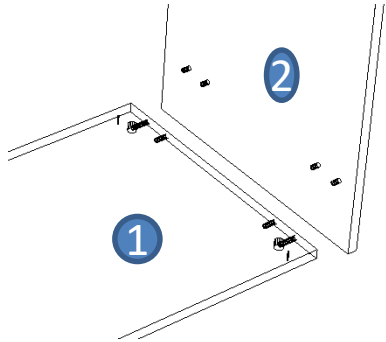

Orta Dikme Birleřtirme

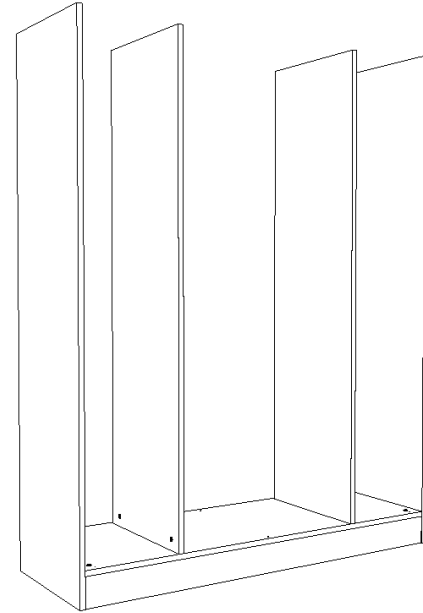
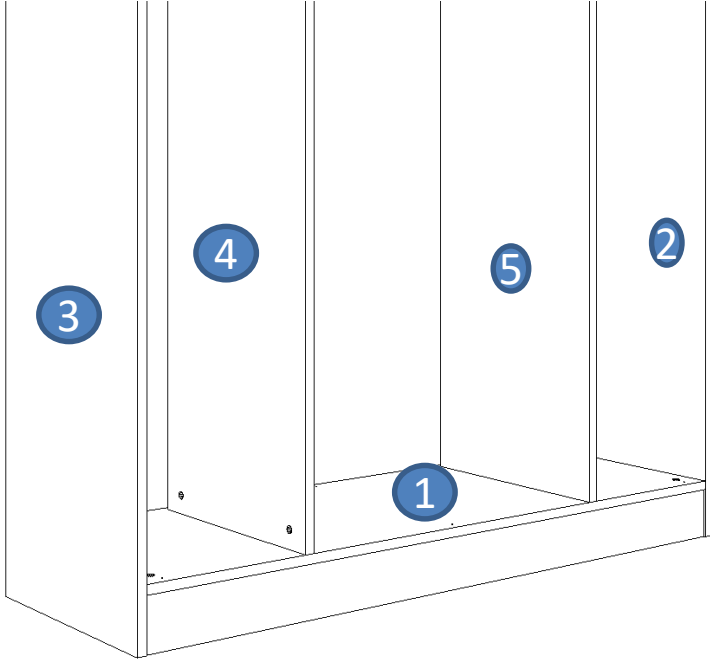
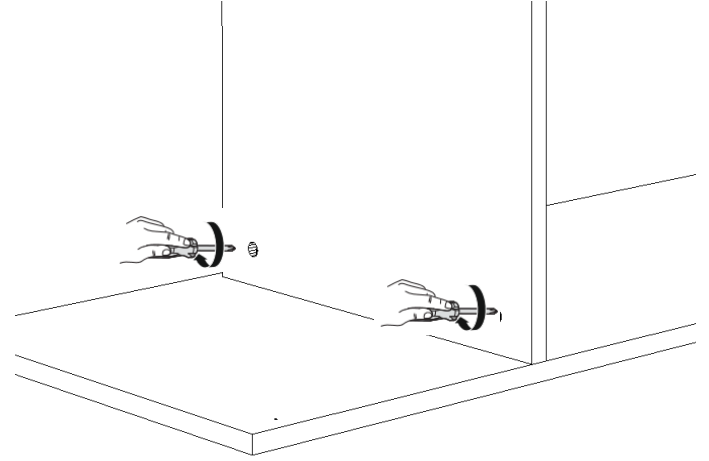
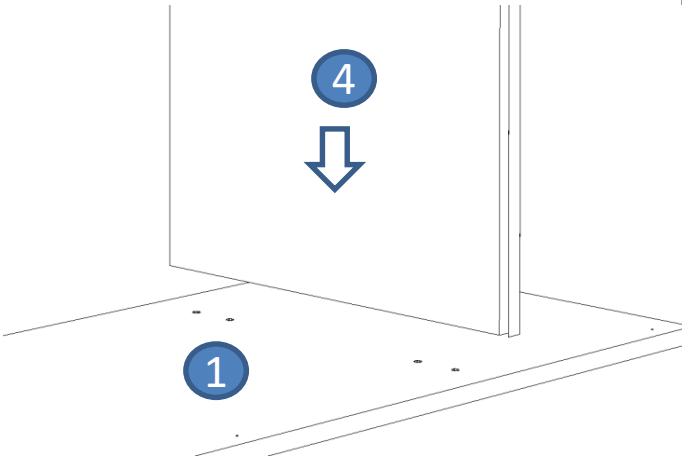

**Sabit Raf
Birleřtirme
Raf Yerleřtirme**

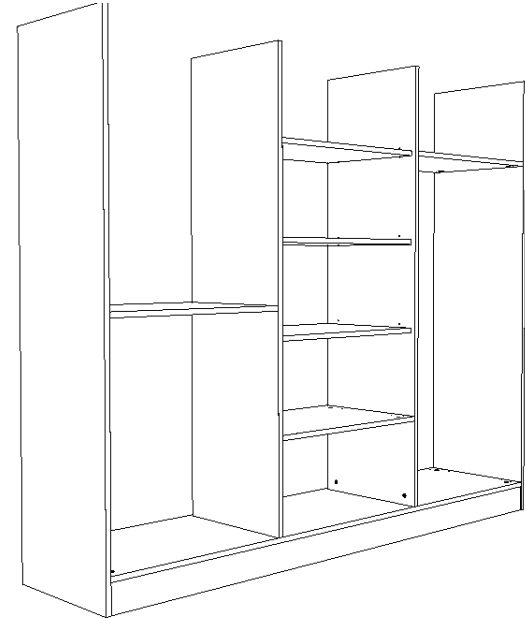
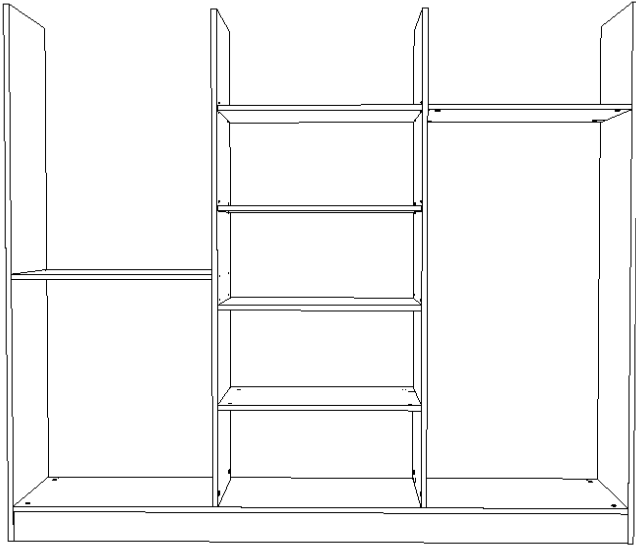
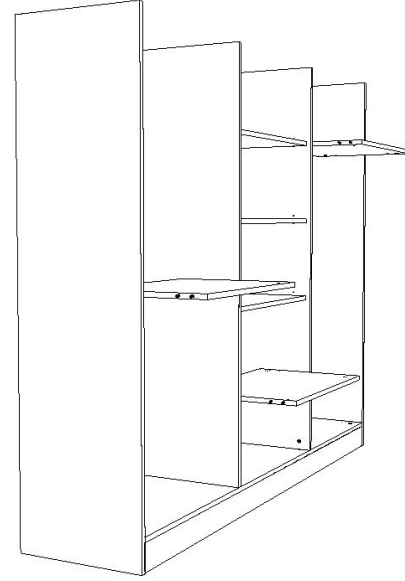
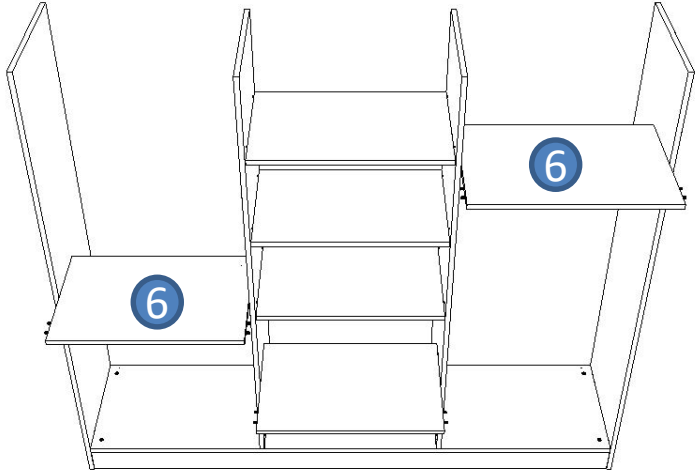

Arkalık Birleştirme

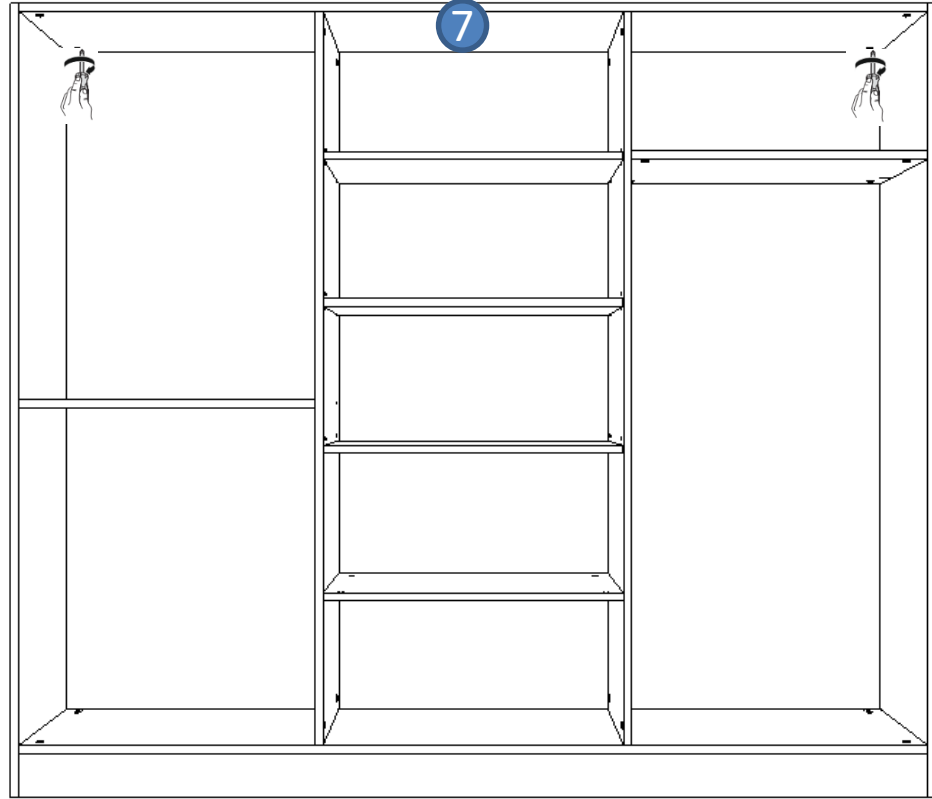
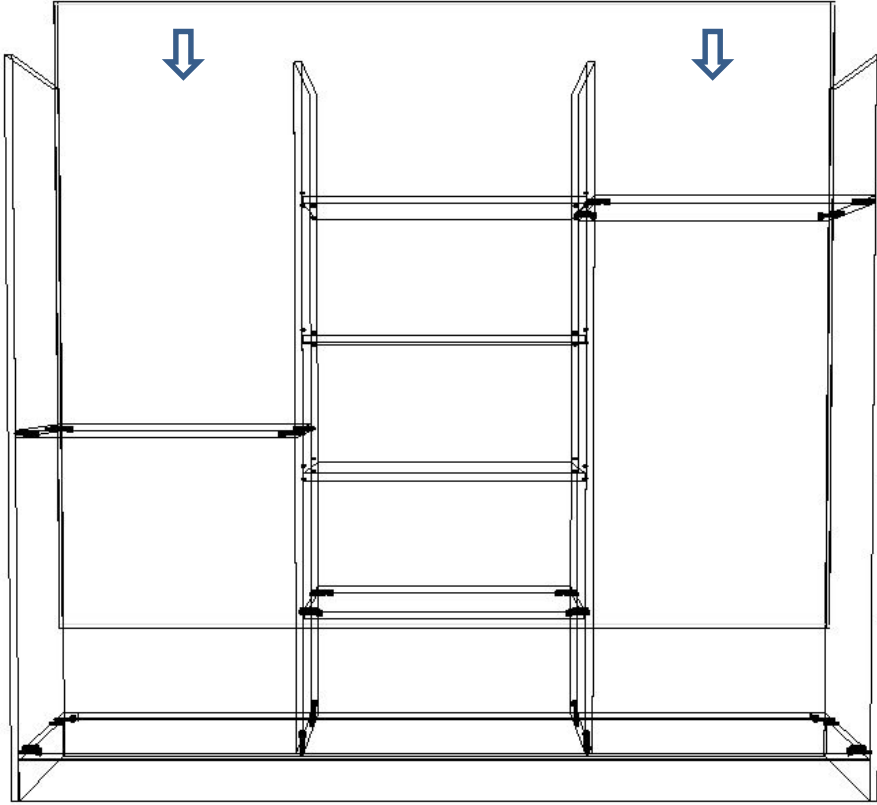

Arkalıkları kurmuş olduğunuz dolabın kanallı kısımlarını yerleştirerek arkalık aparatı ile sabitleyiniz.



Daha sonra 7 numaralı üst tablayı bağlantı noktalarından birleştiriniz

Çekmece ve Kapak Bağlantısı

