

**KARGODAN KAYNAKLI KIRIK VE EKSİKLER İÇİN TEL:0542 445 39 87**

## MONTAJ VE KULLANIM KLAVUZU ASSEMBLY MANUEL

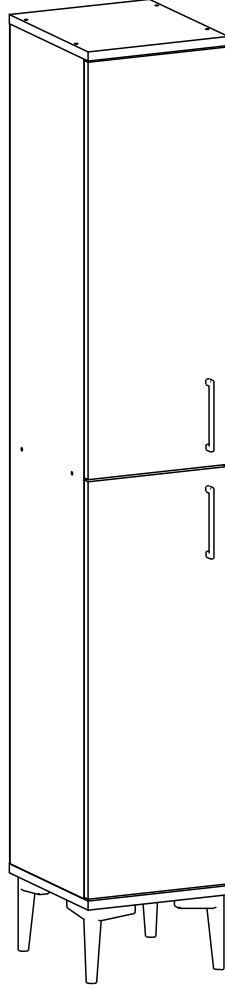

*Sizlere daha iyi hizmet verebilmek ve kullanım dışı kalan atık malzemelerin tekrar üretim süreçlerine kazandırılması için lütfen geri dönüşüme destek verelim...*

*Daha güzel bir DÜNYA için çevreyi koruyalım....*

*Bizi tercih ettiğiniz için teşekkür ederiz :)*

*In order to provide better service to you again and gain to the production process of the use of non-recycled waste material support, please let us ... Let us preserve the environment for a better WORLD... Thank you for choosing us :)*

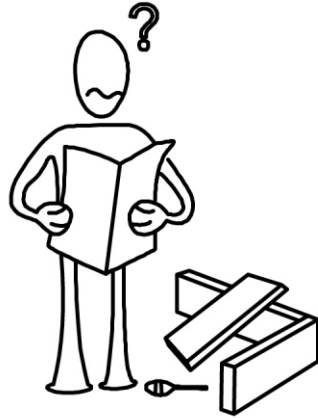
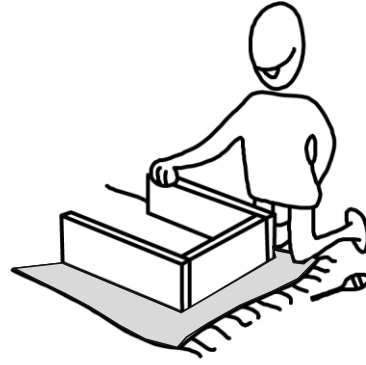
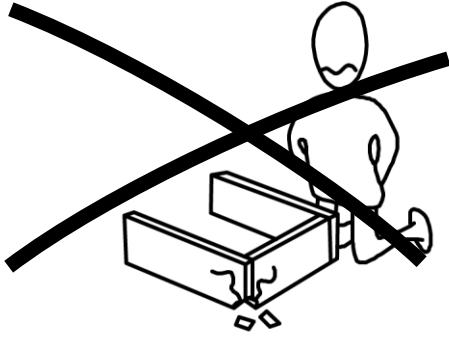
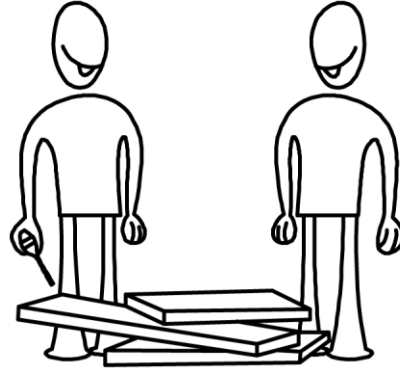
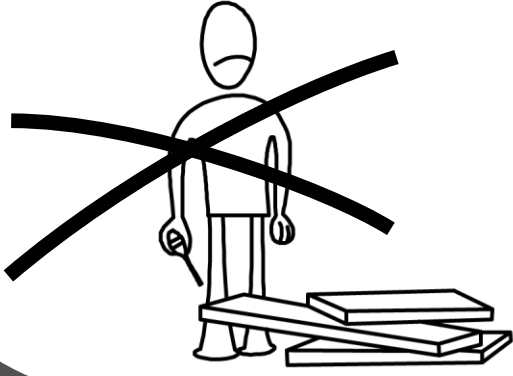

Sayın Müşterimiz,

Satınalmış olduğunuz bu ürün sizlere ulaşmadan önce tarafımızdan her türlü kontrol ve testlere tabii tutulmuştur. Bu durumda bile taşıma sırasında bazı parçaların zarar görmesi mümkündür. Böyle bir durum ile karşılaşırsanız ürünün tamamını geri göndermeyiniz. Sadece zarar gören parçayı isteyiniz. Gerekli parçayı isterken ise servis kartına bakarak tam olarak tanımlayınız. Eksik olan parça en hızlı şekilde tarafınıza gönderilecektir.

Montaja başlamadan önce kutulardan çıkan tüm parça ve aksesuarları listelere göre kontrol ediniz. Parça ve aksesuarların tam ve sağlam olduğunu tespit ettikten sonra montaja başlayınız. Montaja başlamadan önce her parçayı nemli bir bez ile temizleyiniz. Eğer birden fazla ürün aldıysanız herhangi bir karışıklığa sebep vermemek için tek bir ürün montajını yaptıktan sonra diğer ürüne geçiniz.

Ürünleri hiçbir zaman sürterek taşımayınız. Ürünü kaldırarak ve sökerek en az iki kişi ile taşıyınız. Uzun mesafeli taşımalarda ürünü mutlaka paket ile taşıyınız. Almış olduğunuz mobilyalarınızın yüzeylerinin temizlenmesi çok kolaydır. Nemli ve sabunlu bir bez ile veya diğer ev temizleyicileriyle silmek yeterlidir.

Mobilyalar aşırı sıcak, soğuk ve nemden etkilendiklerinden, mobilyanızı bu faktörlerle direkt olarak temas ettirmeyiniz. Mobilyanızı amacı dışında kullanmayınız.

Dear Customer,

The product you bought was subjected to all sorts of tests and control before sending out to you. Even in this situation, sometimes happen that some component is damaged during the transportation. In such case please do not send the whole article back to us. Just request/order the damaged part. While requesting the required part, describe it exactly by looking to service card. Missing part will be sent to you as soon as possible. Before start assembling, please check the whole components and accessories according to the lists. After being sure that every part and accessory are okay and right, start assembling. Before start assembling, please clean all the components with a damp cloth. If you bought more than one product, to prevent confusion be sure that you completed the first product. Then start the other product's assembling.

Never draw the products. While carrying, disassociate and lift the product and carry with minimum 2 people. For long distances carry the product with the package.

It is very easy to clean the surfaces of your product. It is enough to wipe with a damp and soapy cloth or other household cleaners. Do not directly contact your furniture with excessive heat, cold and humidity because the product can be affected.



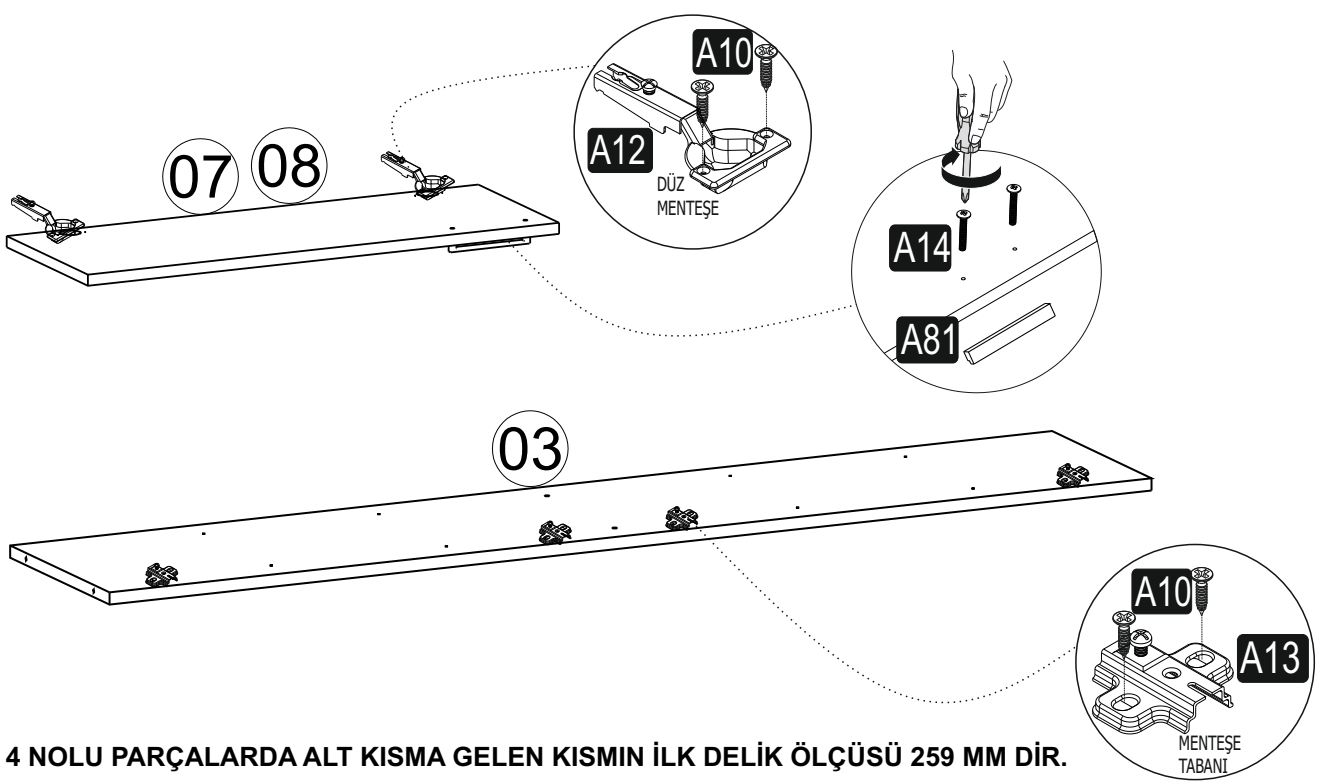

3 VE 4 NOLU PARÇALARDA ALT KISMA GELEN KISIMIN İLK DELİK ÖLÇÜSÜ 259 MM DİR.

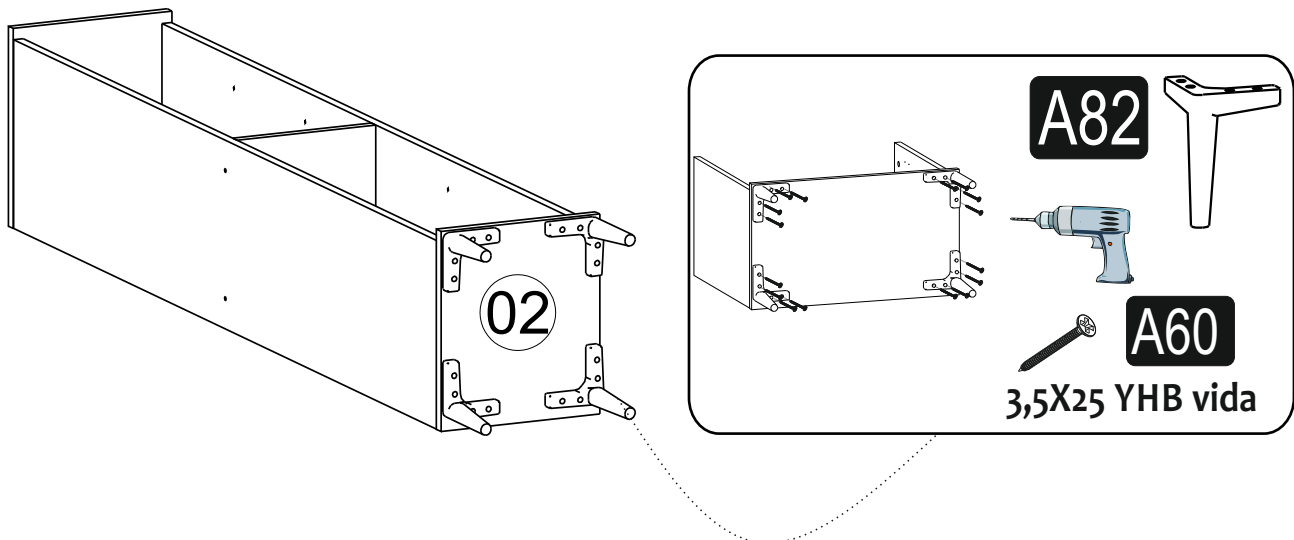
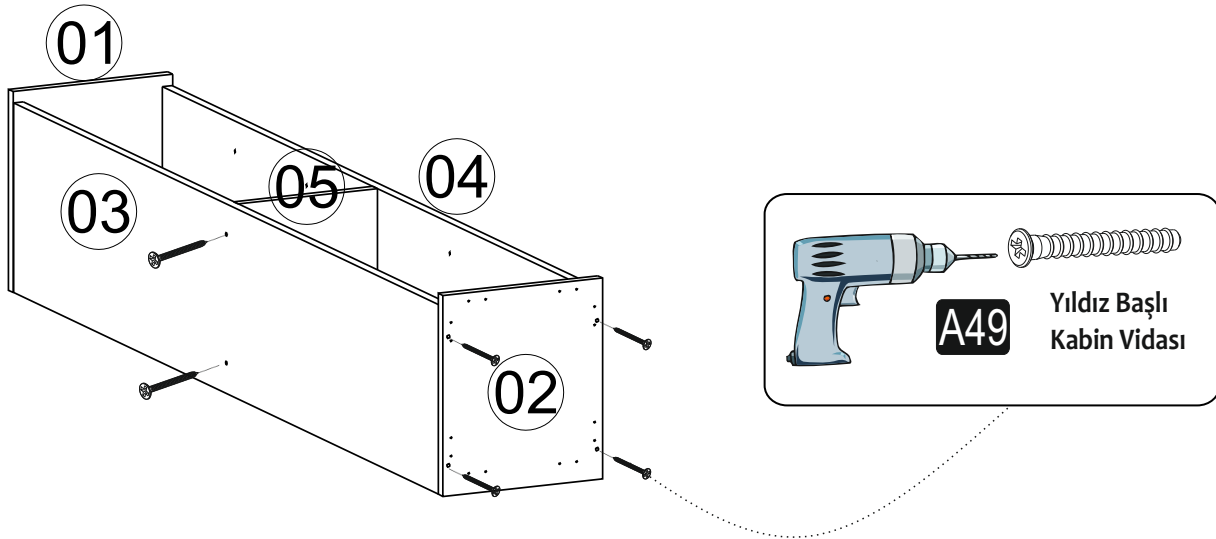

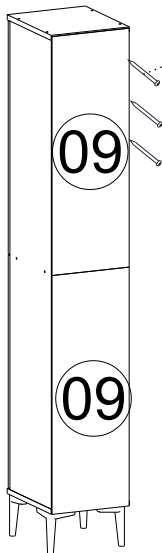
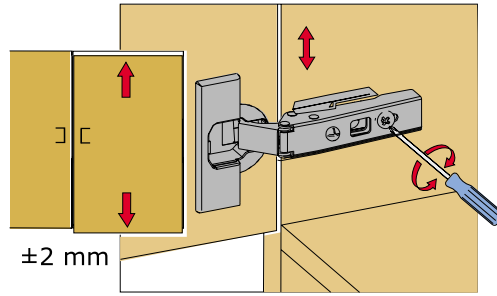
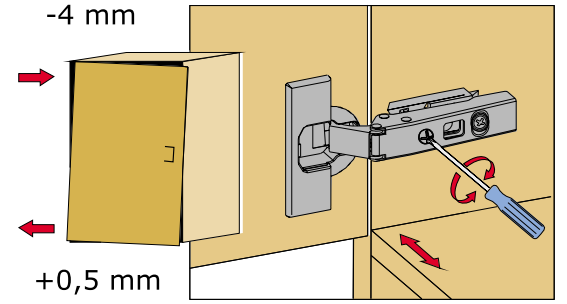
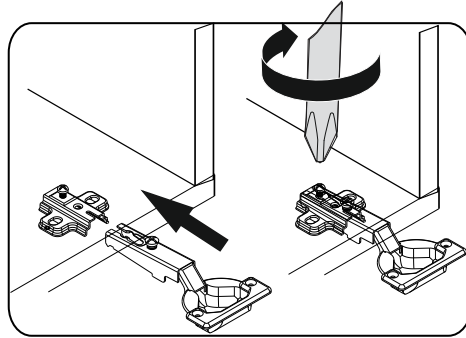
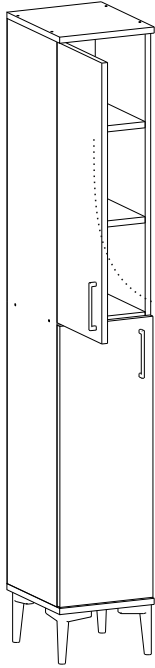
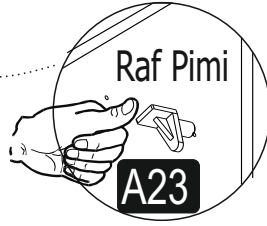
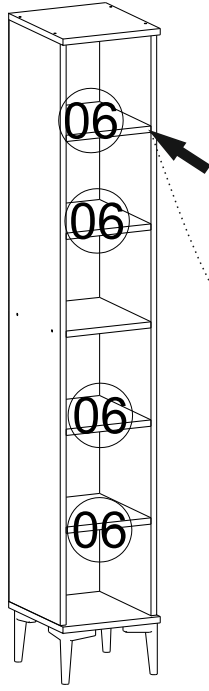

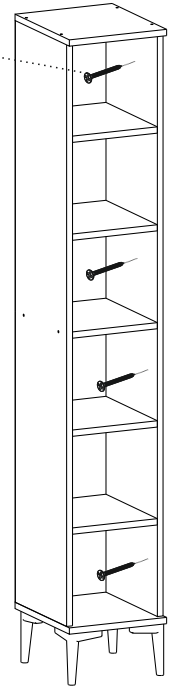
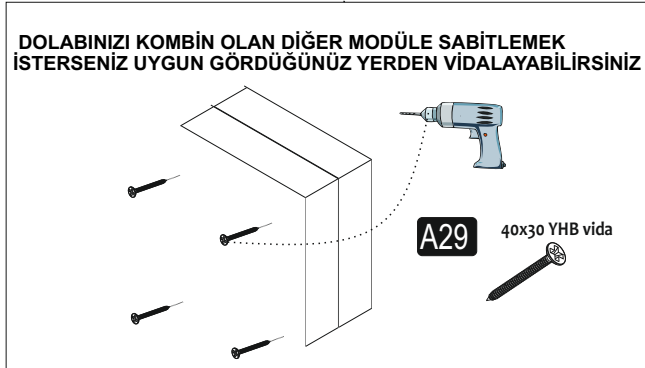
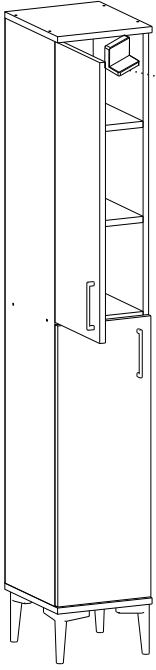
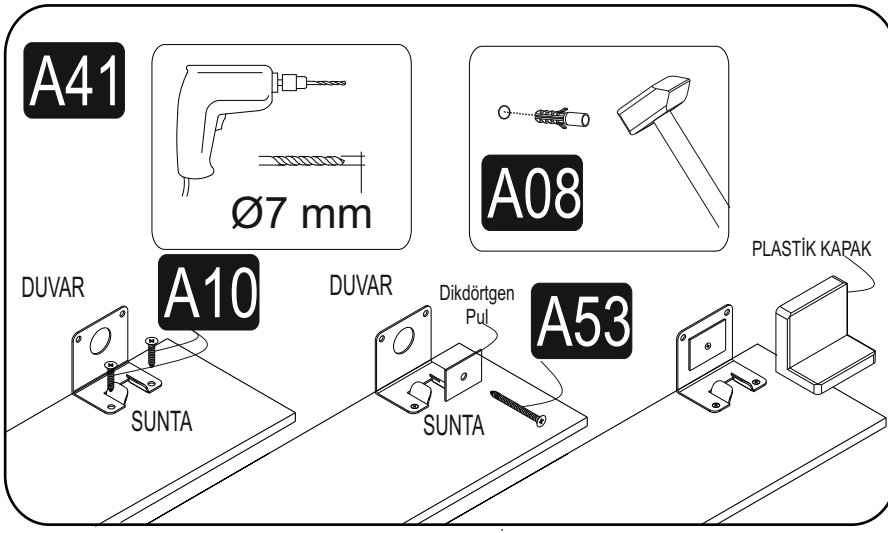

*Diğer ürünlerimizi gördünüz mü?  
Have you seen our other products ?*

**[www.kalenderdekor.com](http://www.kalenderdekor.com)**

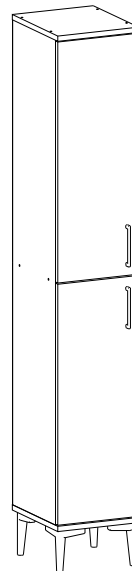

**İYİ GÜNLERDE KULLANINIZ...**

**KARGODAN KAYNAKLI KIRIK VE EKSİKLER İÇİN TEL:0542 445 39 87**

## MONTAJ VE KULLANIM KLAVUZU ASSEMBLY MANUEL

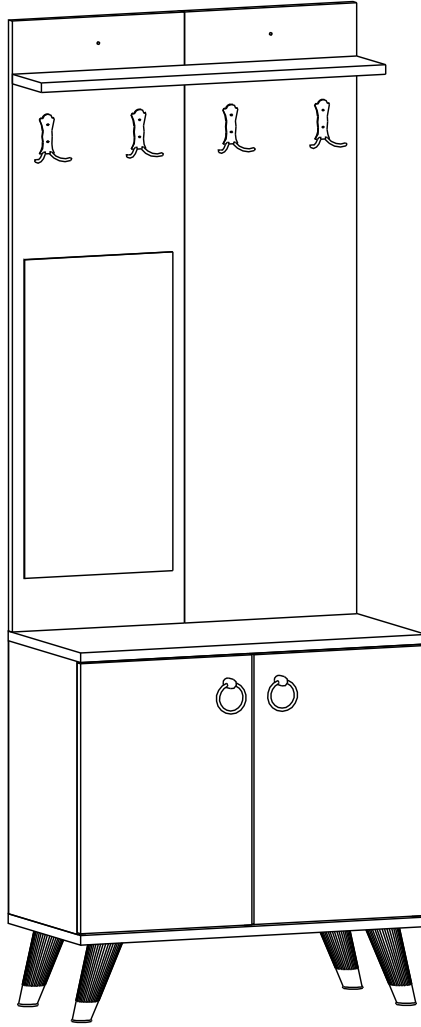

*Sizlere daha iyi hizmet verebilmek ve kullanım dışı kalan atık malzemelerin tekrar üretim süreçlerine kazandırılması için lütfen geri dönüşüme destek verelim...  
Daha güzel bir DÜNYA için çevreyi koruyalım....*

*Bizi tercih ettiğiniz için teşekkür ederiz :)*

*In order to provide better service to you again and gain to the production process of the use of non-recycled waste material support, please let us ... Let us preserve the environment for a better WORLD... Thank you for choosing us :)*

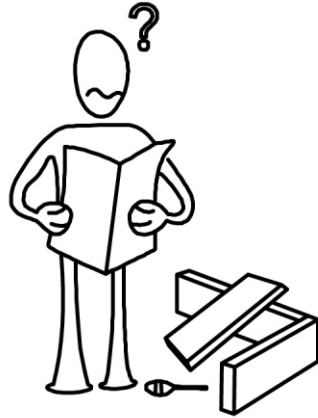
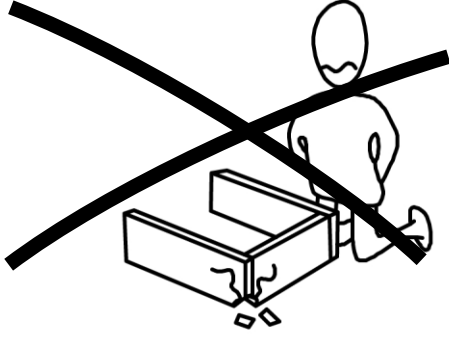
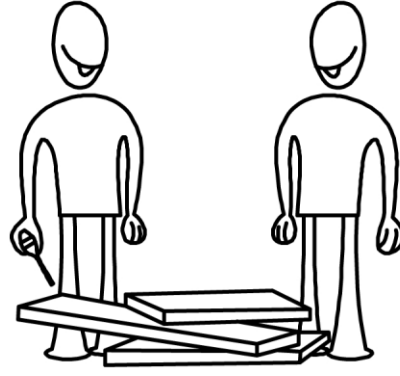
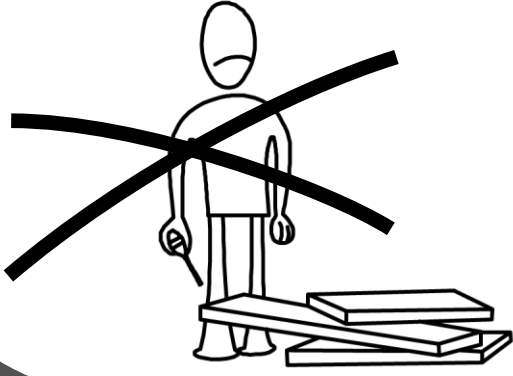

Sayın Müşterimiz,

Satınalmış olduğunuz bu ürün sizlere ulaşmadan önce tarafımızdan her türlü kontrol ve testlere tabii tutulmuştur. Bu durumda bile taşıma sırasında bazı parçaların zarar görmesi mümkündür. Böyle bir durum ile karşılaşırsanız ürünün tamamını geri göndermeyiniz. Sadece zarar gören parçayı isteyiniz. Gerekli parçayı isterken ise servis kartına bakarak tam olarak tanımlayınız. Eksik olan parça en hızlı şekilde tarafınıza gönderilecektir.

Montaja başlamadan önce kutulardan çıkan tüm parça ve aksesuarları listelere göre kontrol ediniz. Parça ve aksesuarların tam ve sağlam olduğunu tespit ettikten sonra montaja başlayınız. Montaja başlamadan önce her parçayı nemli bir bez ile temizleyiniz. Eğer birden fazla ürün aldıysanız herhangi bir karışıklığa sebep vermemek için tek bir ürün montajını yaptıktan sonra diğer ürüne geçiniz.

Ürünleri hiçbir zaman sürterek taşımayınız. Ürünü kaldırarak ve sökerek en az iki kişi ile taşıyınız. Uzun mesafeli taşımalarda ürünü mutlaka paket ile taşıyınız. Almış olduğunuz mobilyalarınızın yüzeylerinin temizlenmesi çok kolaydır. Nemli ve sabunlu bir bez ile veya diğer ev temizleyicileriyle silmek yeterlidir.

Mobilyalar aşırı sıcak, soğuk ve nemden etkilendiklerinden, mobilyanızı bu faktörlerle direkt olarak temas ettirmeyiniz. Mobilyanızı amacı dışında kullanmayınız.

Dear Customer,

The product you bought was subjected to all sorts of tests and control before sending out to you. Even in this situation, sometimes happen that some component is damaged during the transportation. In such case please do not send the whole article back to us. Just request/order the damaged part. While requesting the required part, describe it exactly by looking to service card. Missing part will be sent to you as soon as possible. Before start assembling, please check the whole components and accessories according to the lists. After being sure that every part and accessory are okay and right, start assembling. Before start assembling, please clean all the components with a damp cloth. If you bought more than one product, to prevent confusion be sure that you completed the first product. Then start the other product's assembling. Never draw the products. While carrying, disassociate and lift the product and carry with minimum 2 people. For long distances carry the product with the package.





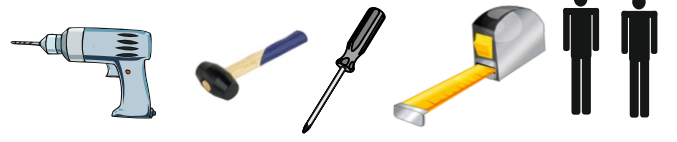





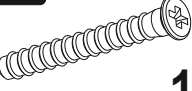

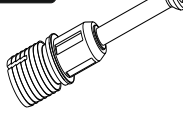
It is very easy to clean the surfaces of your product. It is enough to wipe with a damp and soapy cloth or other household cleaners. Do not directly contact your furniture with excessive heat, cold and humidity because the product can be affected.



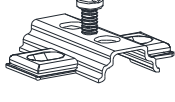

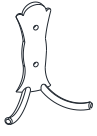
Bu modülün kurulumu için gerekli olan araçlar.

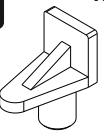
## AKSESUAR LİSTESİ / ACCESSORY LIST

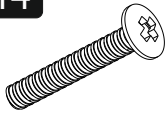
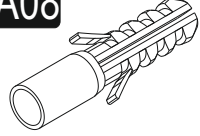
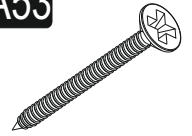
<b>A49</b> Yıldız Kabin Vidası  <b>14x</b>	<b>A01</b> Minifix Gövde  <b>6x</b>	<b>A02</b> Minifix Mil  <b>6x</b>	<b>A16</b> Küçük Yapışkan Tapa Renk 1 <b>X</b> Renk 2 <b>14x</b> 	<b>A10</b> 3,5x18 YHB Vida  <b>44x</b>
<b>A12</b> Düz Mentеше  <b>4x</b>	<b>A13</b> Mentеше Altlığı  <b>4x</b>	<b>A28</b> Arkalık Çivisi  <b>20x</b>	<b>A36</b> Askı Elemanı  <b>4x</b>	<b>A80</b> 15 mm. ayak  <b>4x</b>
<b>A23</b> Raf Pimi  <b>12x</b>	<b>A79</b> Yuvarlak Kulp  <b>2x</b>	<b>A14</b> M4x22 Kulp Vidası  <b>2x</b>	<b>A08</b> Ø8 Lik Dubel  <b>2x</b>	<b>A53</b> 5x70 YHB Vida  <b>2x</b>

## PARÇA KODLAMA / GENERAL VIEW

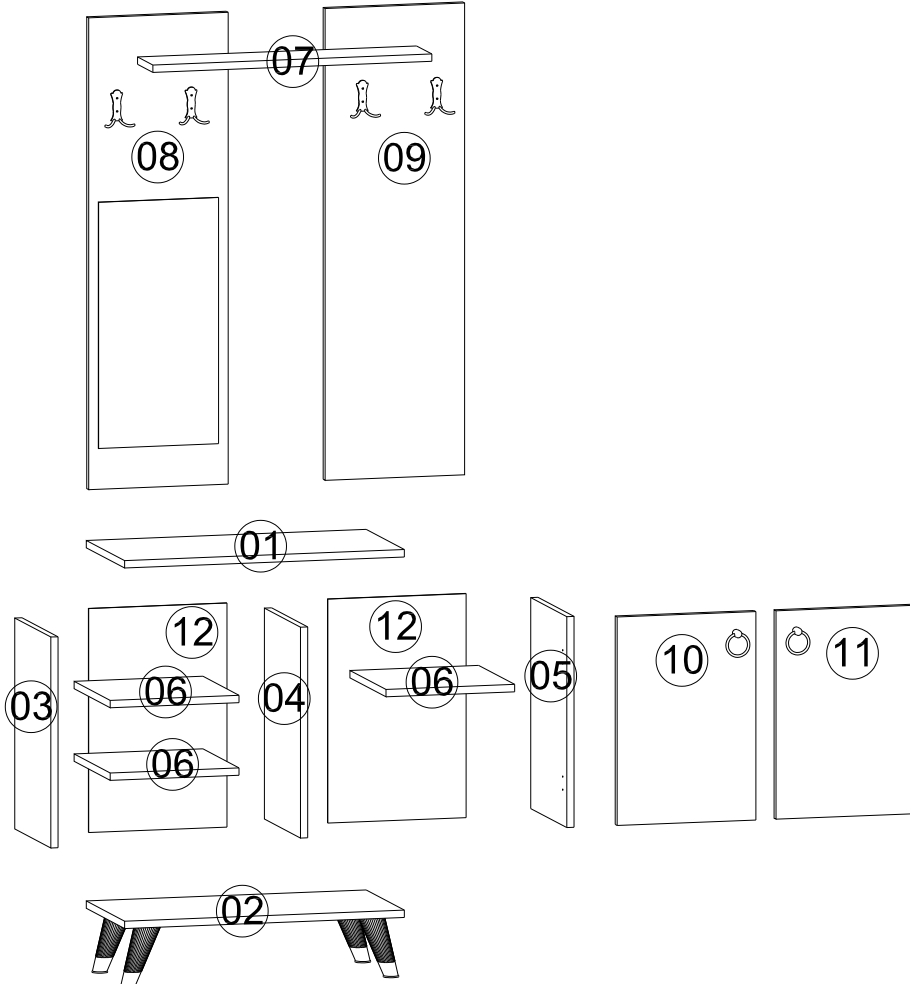

03 05

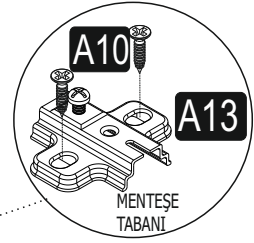
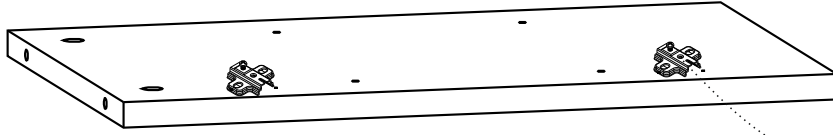

10 11

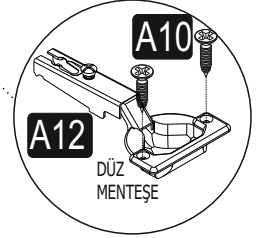
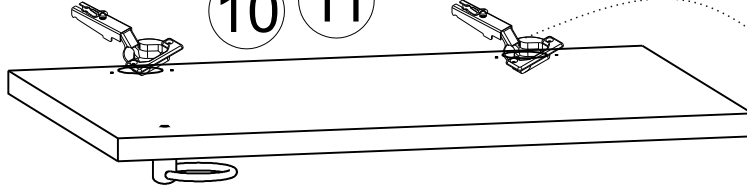

A14

A79

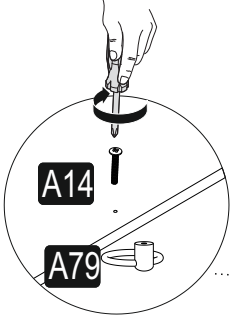

08 09

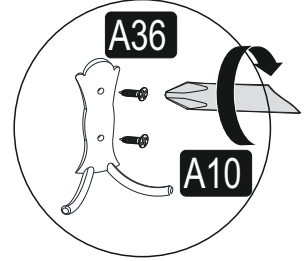
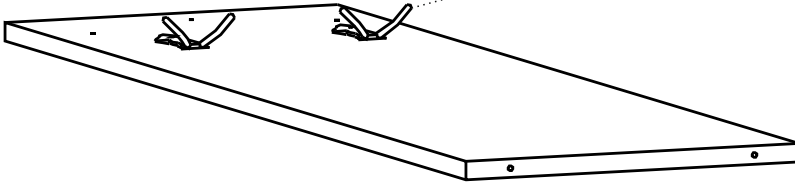

### Plastik Ayak 150 mm.

- 1) İç parçayı (Siyah parça) vidalayın.
- 2) Dış parçayı (Beyaz parça) takmak için sıkıca bastırın.

A10

Sunta Vidası  
3,5x18 4 Adet

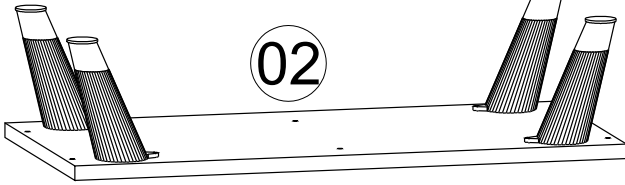
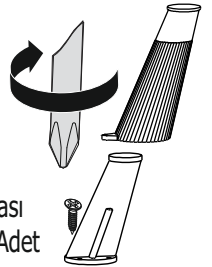

02

03

04

05

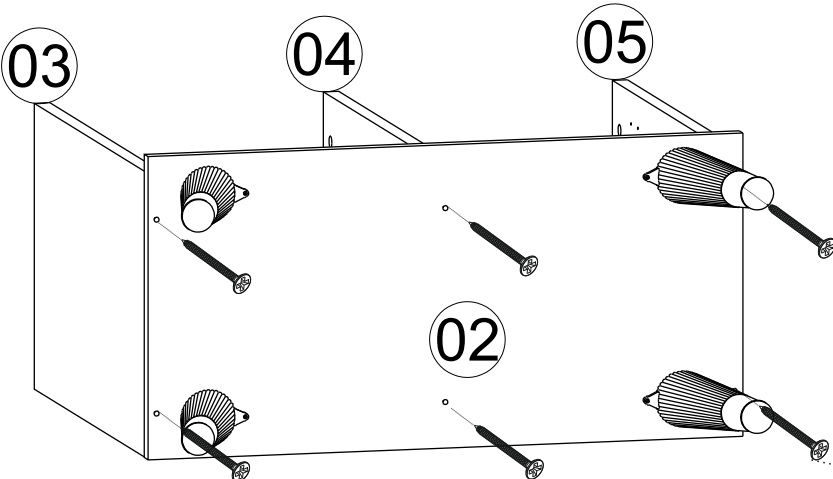

02



A49

Yıldız Başlı  
Kabin Vidası

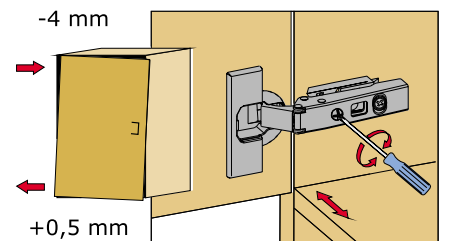
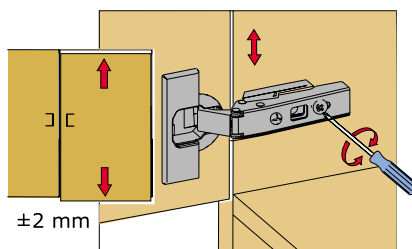
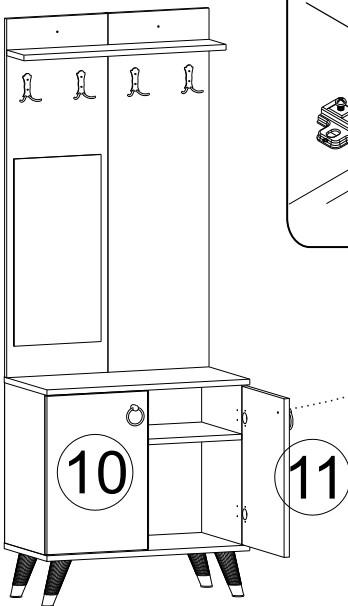
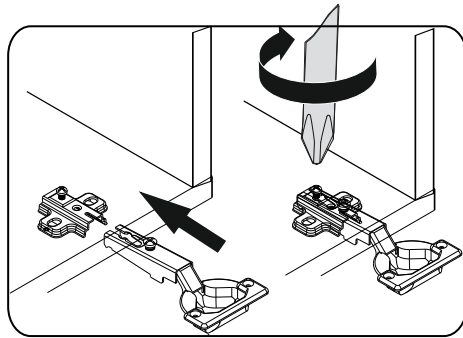
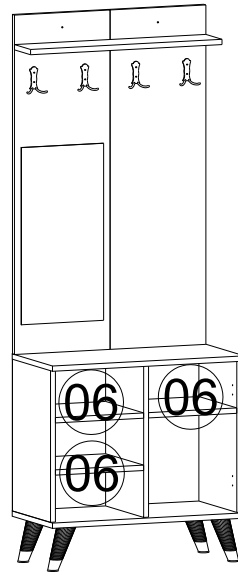
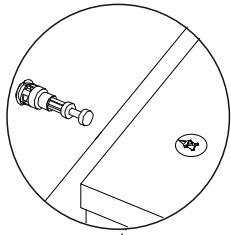
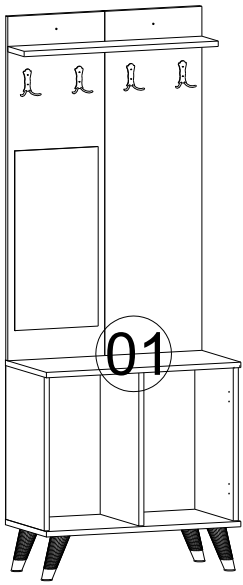
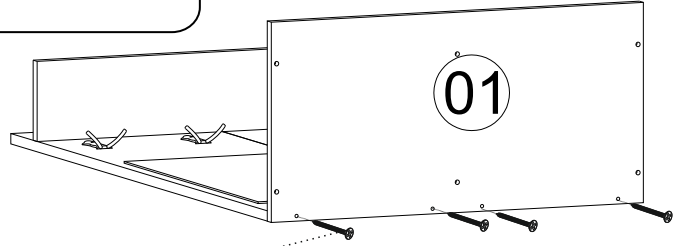
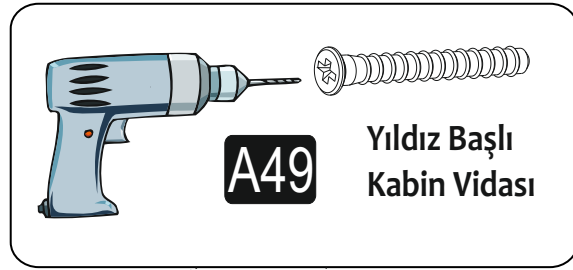
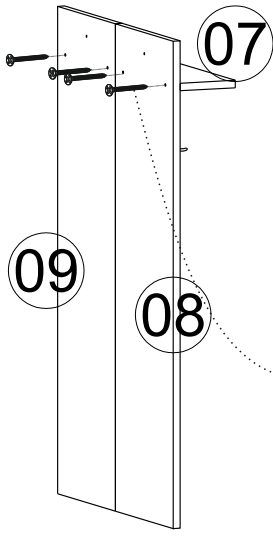

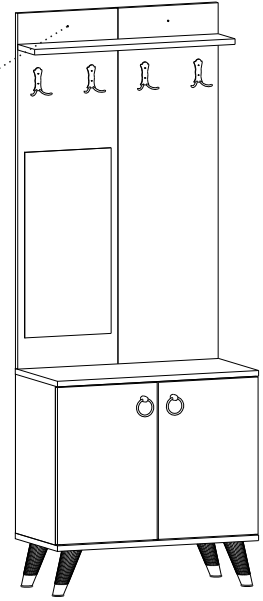
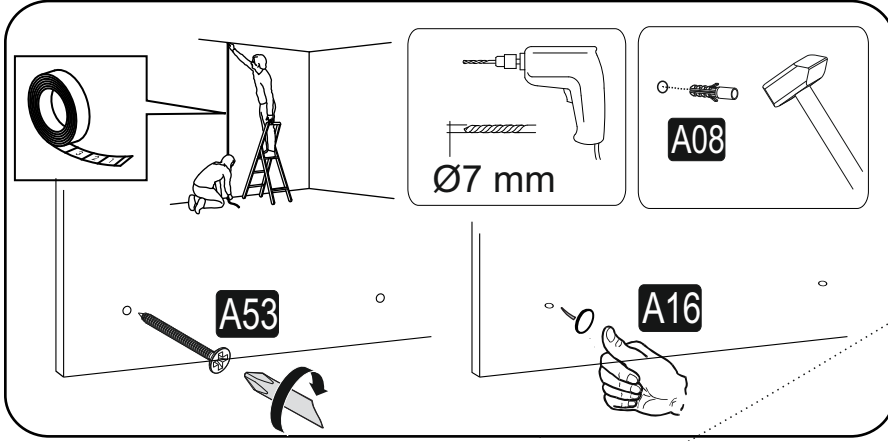
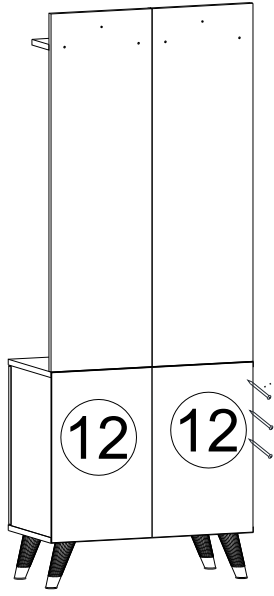

**İYİ GÜNLERDE KULLANINIZ...**

*Diğer ürünlerimizi gördünüz mü?  
Have you seen our other products ?*  
**[www.kalenderdekor.com](http://www.kalenderdekor.com)**