

5 KAPILI 2 ÇEKMECELİ GARDIROP

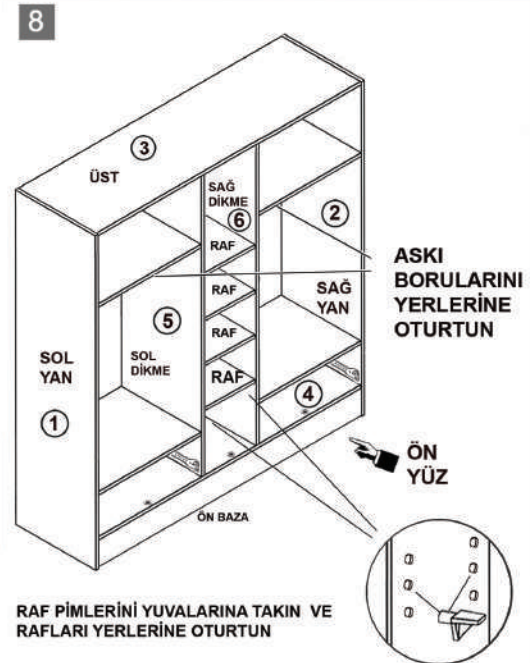
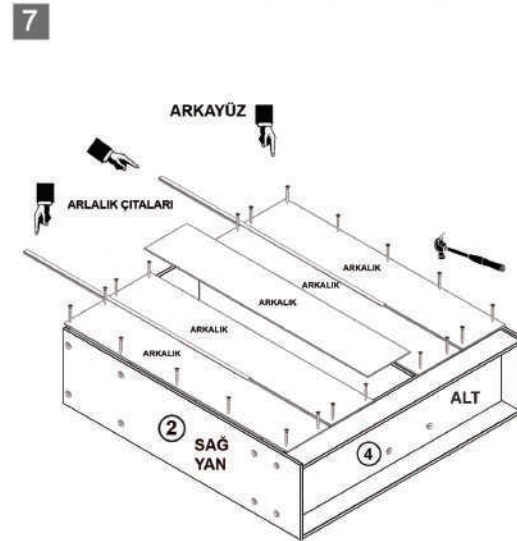
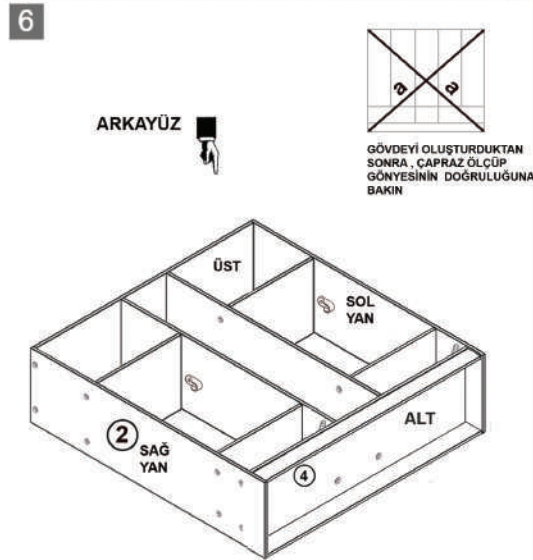
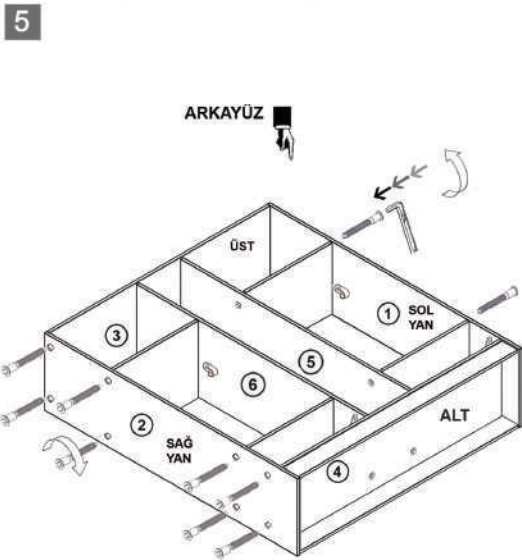
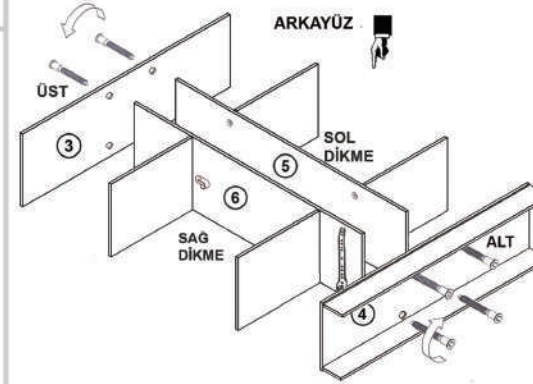
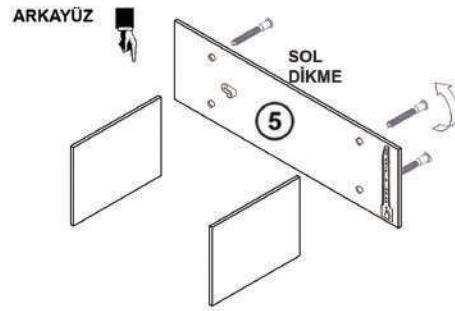
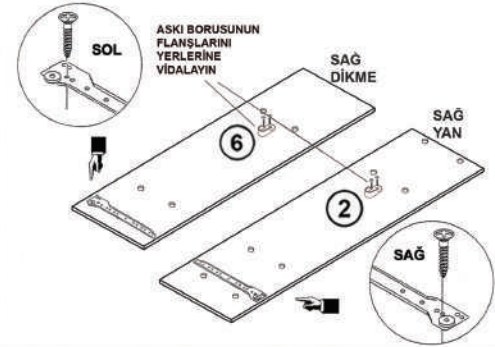
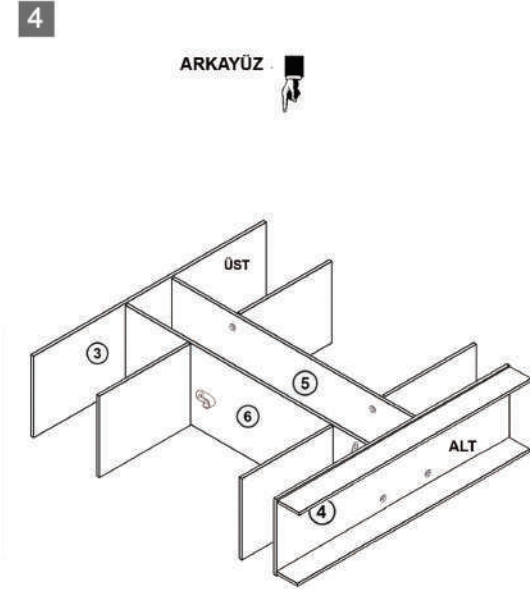
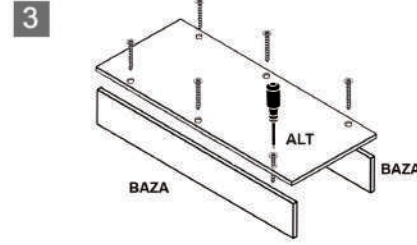
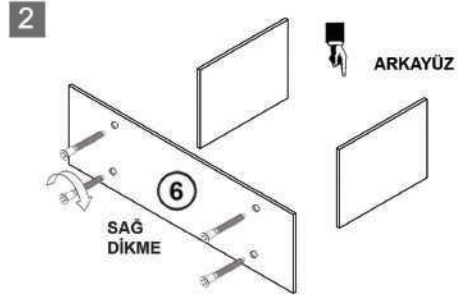
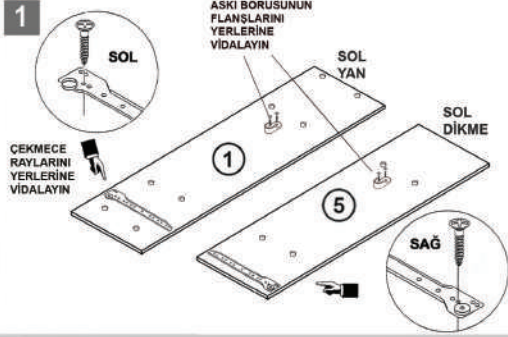

DİKKAT ! ARKALIKLARI ÇAKMADAN ÖNCE ARKALIK ÇİTALARINI İKİ ARKALIK ARASINA SÜREREK TAKIN

5 KAPILI 2 ÇEKMECELİ GARDIROP

9

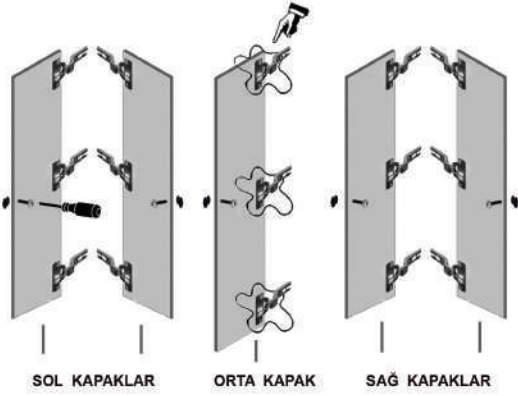

SOL KAPAKLAR

ORTA KAPAK

SAĞ KAPAKLAR

5

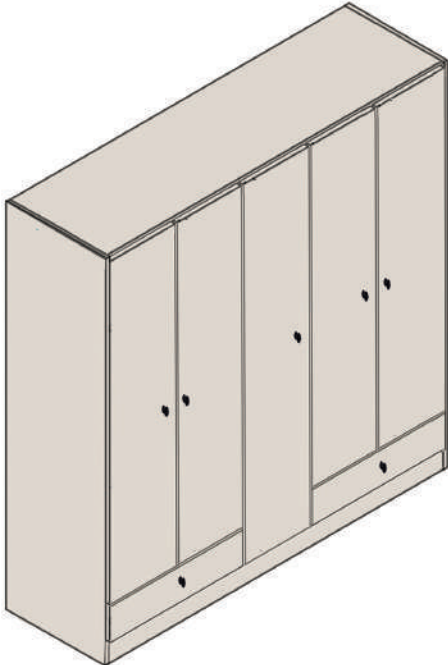

MENTEŞE AYARI

A+B

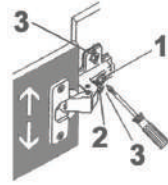

C

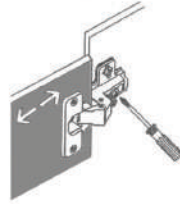

D

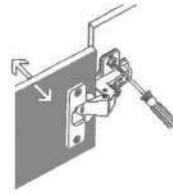

HATA A : KAPAK AÇILIRKEN KAPAĞIN ALTI SIKIŞIYORSA

YAPILMASI GEREKENLER:

- 1- AŞAĞIDAKİ MENTEŞEDEN 1 NOLU VİDAYI GEVŞETİN
- 2- 2 NOLU VİDAYI ÇEVİREREK İÇERİ DOĞRU SOKUN.
- 3- 1 NOLU VİDAYI TEKRAR SIKILAŞTIRIN.

EĞER KAPAK AÇILIRKEN KAPAĞIN ÜSTÜ SIKIŞIYORSA BU SEFER AYNİ İŞLEMLER ÜST MENTEŞEYE YAPILACAKTIR.

HATA B : KAPAK DOLABA DOKUNUYORSA. ÖRNEĞİN İKİ KAPAK ARASI BOŞLUĞUN ÜSTTE VE ALTTA AYNİ OLMADIĞI ZAMANLARDA.

YAPILMASI GEREKENLER

- 1- 1 NOLU VİDAYI GEVŞETİN.
- 2- 2 NOLU VİDAYI ÇEVİREREK İÇİNE DOĞRU SOKUNUZ.
- 3- 1 NOLU VİDAYI TEKRAR SIKILAŞTIRINIZ.

HATA C : KAPAK İÇERİ VEYA DIŞARI DOĞRU DÜŞÜYORSA

YAPILMASI GEREKENLER

- 1- AŞAĞIDAKİ MENTEŞEDEN 1 NOLU VİDAYI GEVŞETİN KAPAĞI İÇERİ VEYA DIŞARI DOĞRU İTİNİZ.
- 2- 1 NOLU VİDAYI TEKRAR SIKILAŞTIRINIZ.

HATA D : HATALI VE FARKLI KAPAK ARALARI OLDUĞUNDA

YAPILMASI GEREKENLER

- 1- 3 NOLU VİDAYI GEVŞETİN
- 2- KAPAĞI ARALARINDAKİ MESAFELER EŞİT OLANA KADAR YUKARI VEYA AŞAĞI İTİNİZ.
- 3- 3 NOLU VİDAYI SIKIŞTIRINIZ.

1

ÇEKMECE MONTAJ

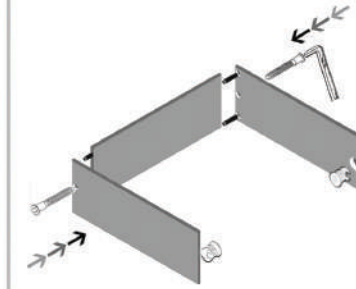

2

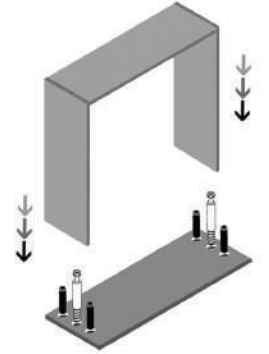

3

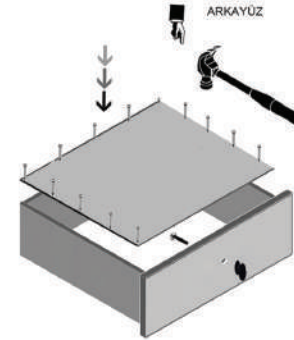

4

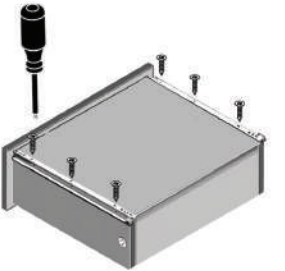

DİKKAT ! BU ÜRÜNÜN ÇEKMECELERİNİN SAĞI VE SOLU VARDIR

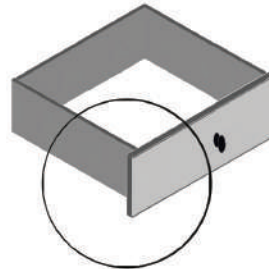

SOL ÇEKMECE

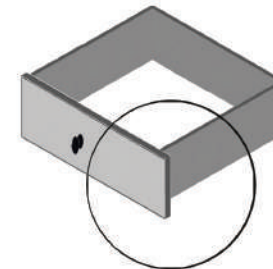

SAĞ ÇEKMECE