

TRENDSTYLE TEKLİ MODÜL BAZALI

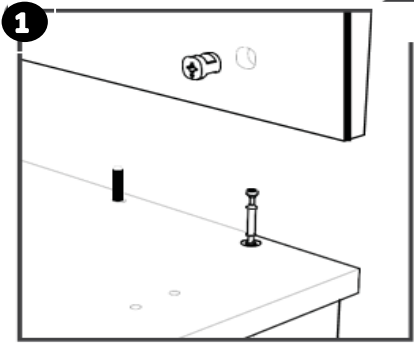

7 ve 8 numaralı baza parçaları 1 Numaralı parçanın alt yüzüne monte edilir.

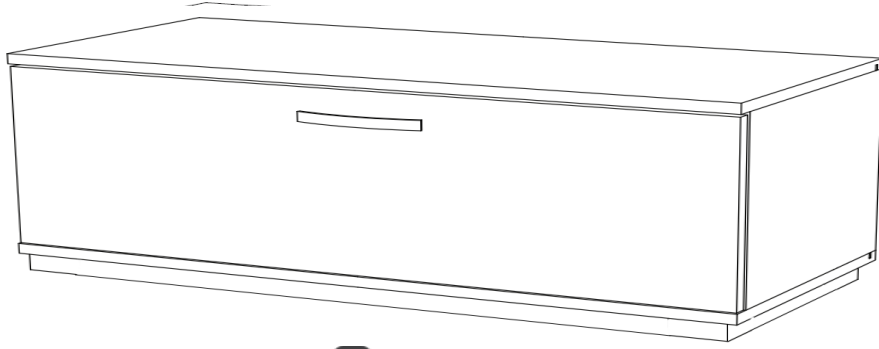
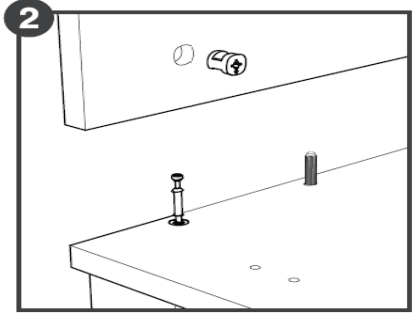
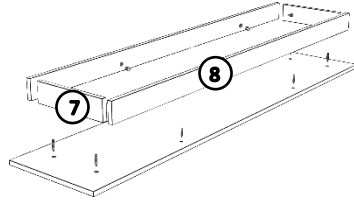

Aynı parçanın diğer yüzüne '4' numaralı minifix mili ve '5' numaralı kavilyalar takılarak '2-3' numaralı parçalar monte edilir. Daha sonra '3' numaralı minifix başı üzerindeki ok milin gireceği yönde olarak monte edilir. (Sağa doğru iyice çevrilerek kilitlenir.)

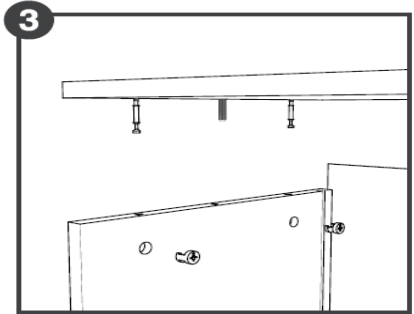
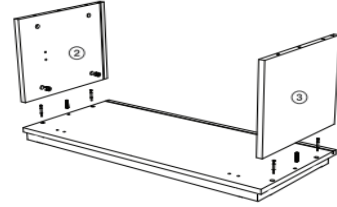

Arka parça yan ve alt parçadaki kanallara yerleştirilir. '4' numaralı parça monte edilir.

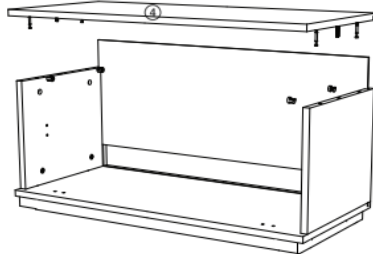

12x



3x

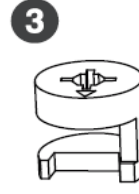

16x



16x



4x

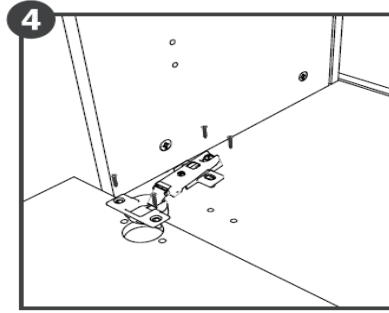

'1' numaralı vidalar yardımıyla menteşeler öncelikle kapaklara, sonrasında dolap gövdesine monte edilir.

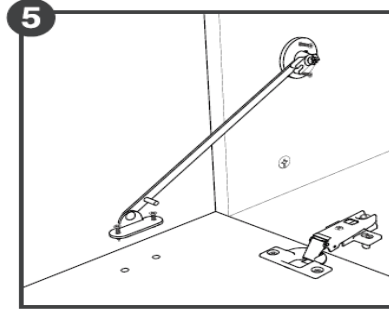
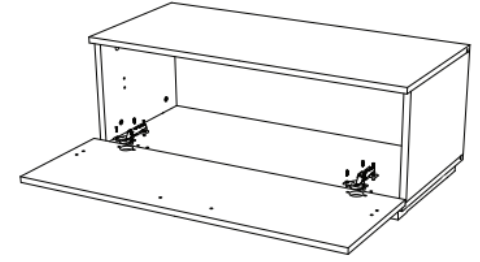

Düşme kapak makasları '1' numaralı vidalar yardımıyla '2' ve '3' numaralı parçalara ve kapaklara monte edilir. (Her kapakta 1 adet kapak makası kullanılır.)

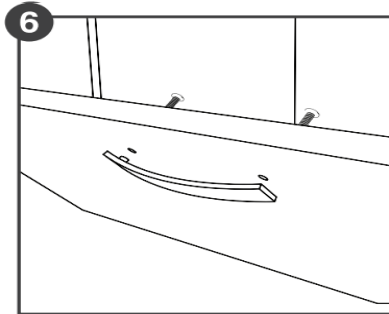
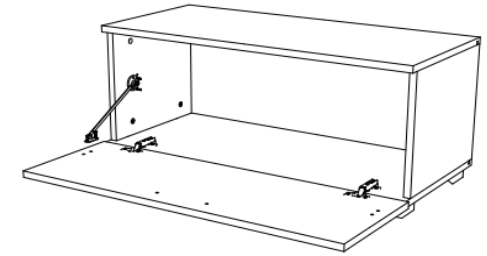

Kulplar '2' numaralı vida yardımıyla kapaklara monte edilir.

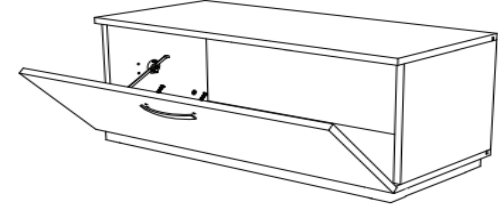

TRENDSTYLE ORTA MODÜL BAZALI

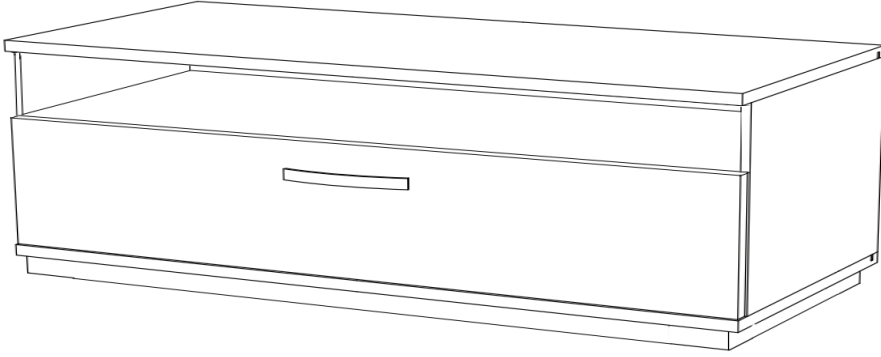

12x



3x

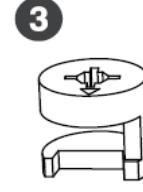

16x



16x



4x



4x

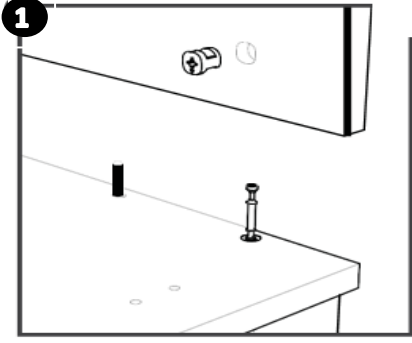

7 ve 8 numaralı baza parçaları 1 Numaralı parçanın alt yüzüne monte edilir.

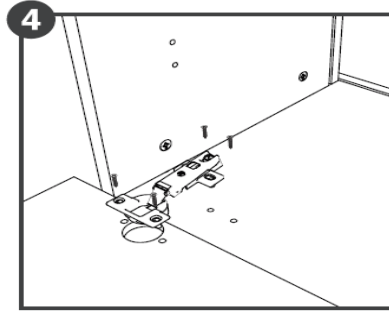
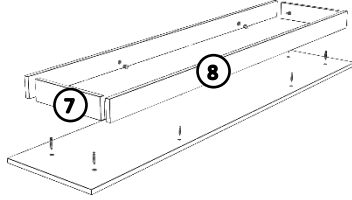

'1' numaralı vidalar yardımıyla menteşeler öncelikle kapaklara, sonrasında dolap gövdesine monte edilir.

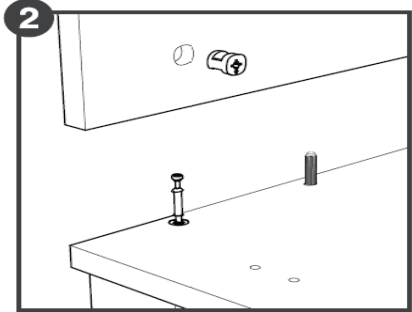
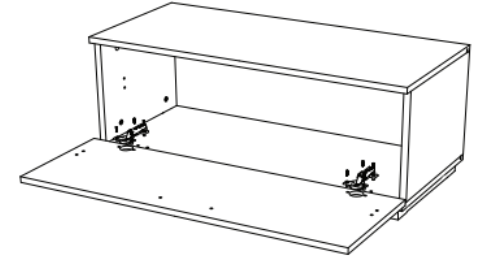

Aynı parçanın diğer yüzüne '4' numaralı minifix mili ve '5' numaralı kavilyalar takılarak '2-3' numaralı parçalar monte edilir. Daha sonra '3' numaralı minifix başı üzerindeki ok milin gireceği yönde olarak monte edilir. (Sağa doğru iyice çevrilerek kilitlenir.)

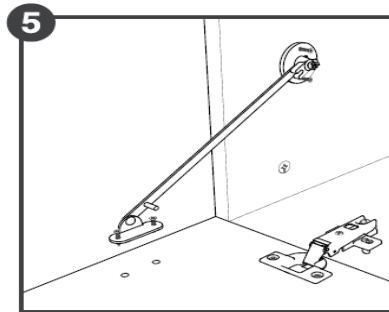
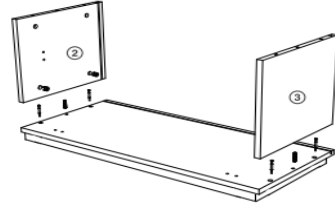

6 numaralı raf pimleri takıldıktan sonra 6 numaralı parça yerleştirilir.

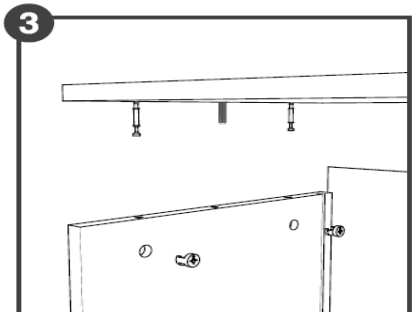
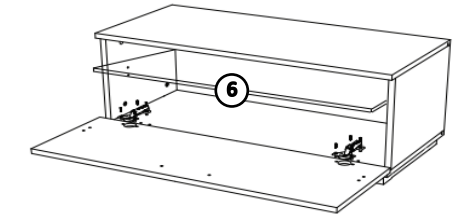

Arka parça yan ve alt parçadaki kanallara yerleştirilir. '4' numaralı parça monte edilir.

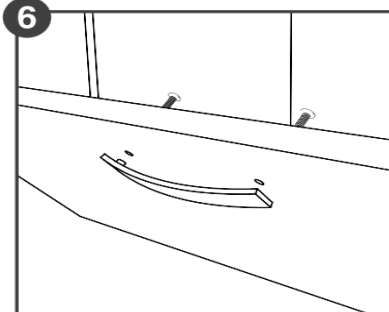
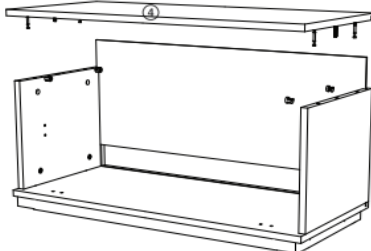

Kulplar '2' numaralı vida yardımıyla kapaklara monte edilir.

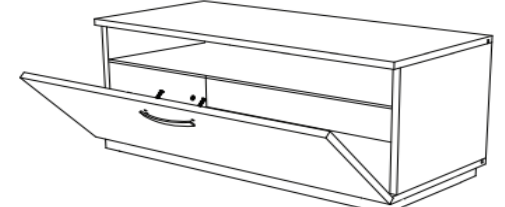

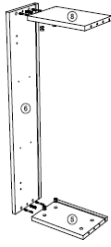
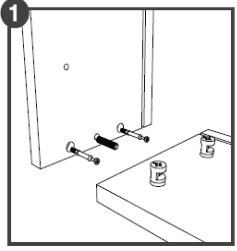
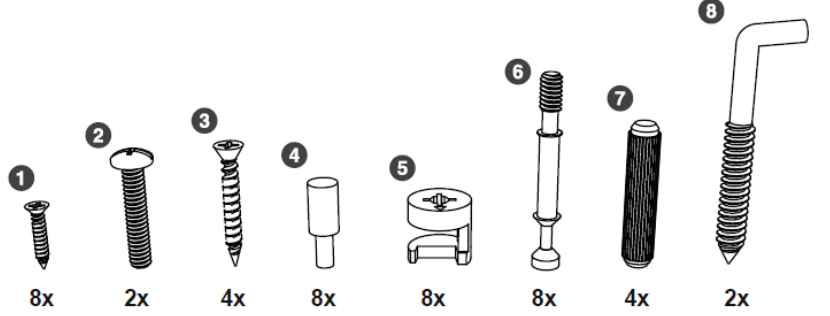
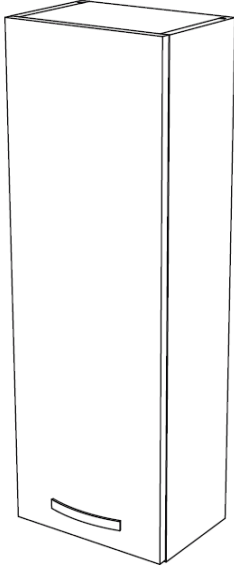

'6' numaralı parça üzerindeki dört adet metal yuvaya '6' numaralı minifix mili ve '7' numaralı kavilyalar takılarak '5-8' numaralı parçalar monte edilir. Daha sonra '5' numaralı minifix başı üzerindeki ok milin gireceği yönde olarak monte edilir.
(Sağa doğru iyice çevrilerek kilittir.)

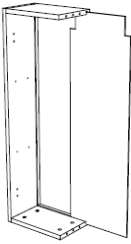
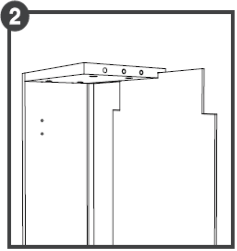

Arka parça yan, alt ve üst parçadaki kanallara yerleştirilir.

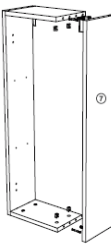
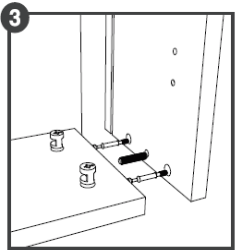

'7' numaralı parça üzerindeki dört adet metal yuvaya '6' numaralı minifix mili ve '7' numaralı kavilyalar takılarak diğerleriyle birleştirilip, aynı yöntemle '5' numaralı minifix başı kullanılarak sabitlenir.
(Sağa doğru iyice çevrilerek kilittir.)

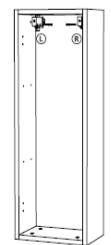
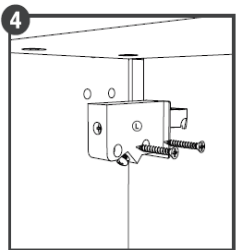

Plastik askı elemanı üzerinde 'L' yazılı parça sola ('6' numaralı parça) 'R' yazılı parça sağa ('7' numaralı parça) '3' numaralı vida kullanılarak metal kısımları dolap arkasından çıkacak şekilde monte edilir.

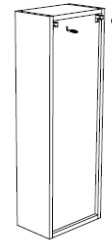
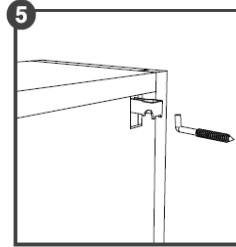

Ürün beraberinde verilen delik şablonundan faydalanılarak duvara 8 mm matkapla iki adet delik delindikten sonra '8' numaralı askı vidaları uçları 1 cm dışarıda kalacak şekilde takılır. Ünite duvara asıldığında plastik askı elemanı üzerinde bulunan üstteki vida saat yönünde çevrildiğinde dolap duvarın yaklaştırır. Altta çapraz duran vida ise aşağı-yukarı hareket sağlayarak dolap teraziye getirir.

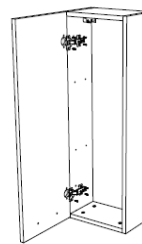
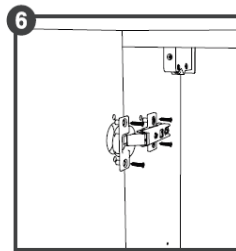

'1' numaralı vidalar yardımcı menteşeler öncelikle kapaklara, sonrasında dolap gödesine monte edilir.

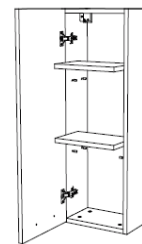
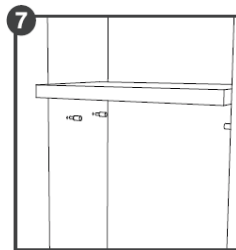

'4' numaralı raf pimleri '6-7' numaralı parçalar üzerinde bulunan minik deliklere taktıldıktan sonra raflar yerleştirilir.

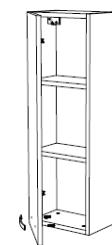
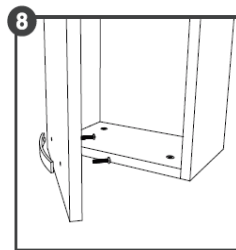

Kulplar '2' numaralı vidalar yardımıyla kapaklara monte edilir.