

TRENDSTYLE TEKLİ MODÜL BAZALI

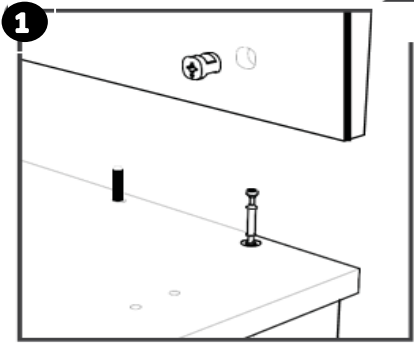

7 ve 8 numaralı baza parçaları 1 Numaralı parçanın alt yüzüne monte edilir.

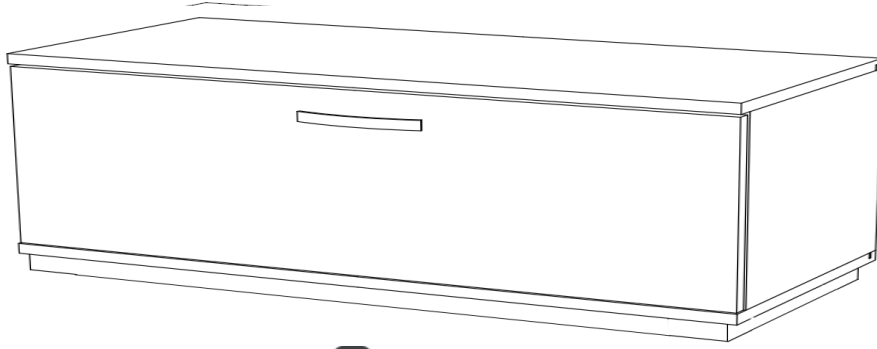
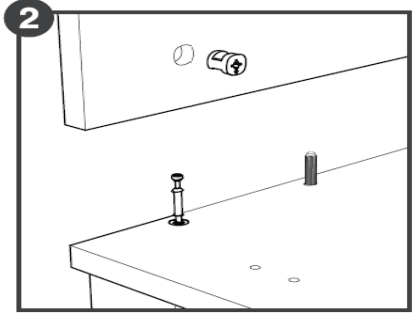
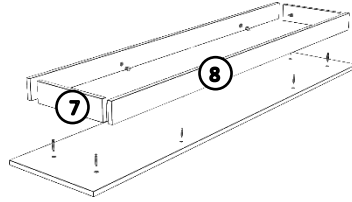

Aynı parçanın diğer yüzüne '4' numaralı minifix mili ve '5' numaralı kavilyalar takılarak '2-3' numaralı parçalar monte edilir. Daha sonra '3' numaralı minifix başı üzerindeki ok milin gireceği yönde olarak monte edilir. (Sağa doğru iyice çevrilerek kilitlenir.)

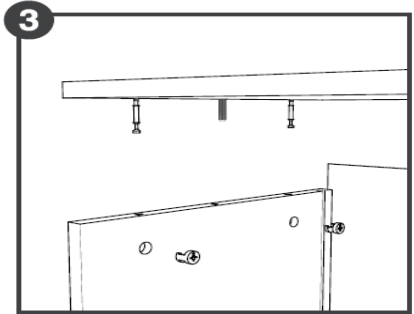
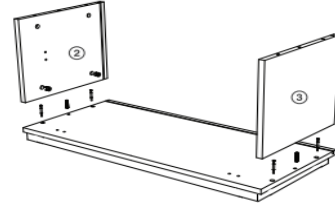

Arka parça yan ve alt parçadaki kanallara yerleştirilir. '4' numaralı parça monte edilir.

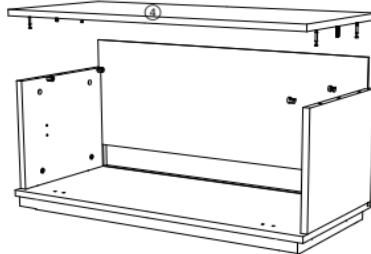

12x



3x

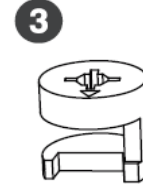

16x



16x



4x

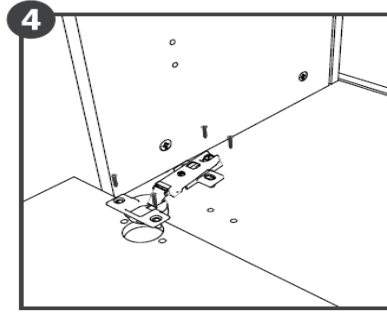

'1' numaralı vidalar yardımıyla menteşeler öncelikle kapaklara, sonrasında dolap gövdesine monte edilir.

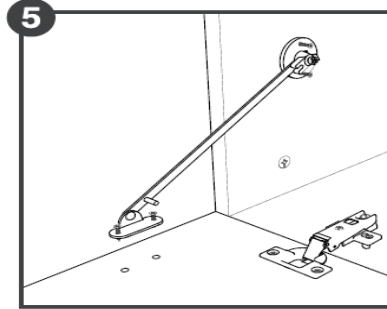
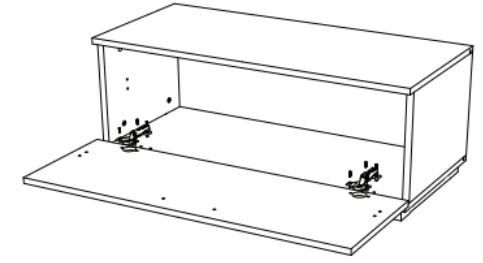

Düşme kapak makasları '1' numaralı vidalar yardımıyla '2' ve '3' numaralı parçalara ve kapaklara monte edilir. (Her kapakta 1 adet kapak makası kullanılır.)

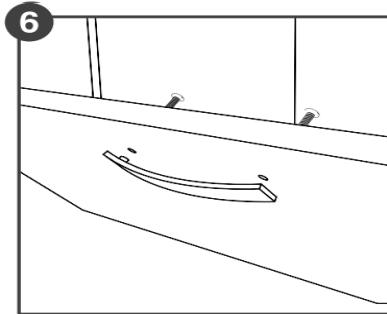
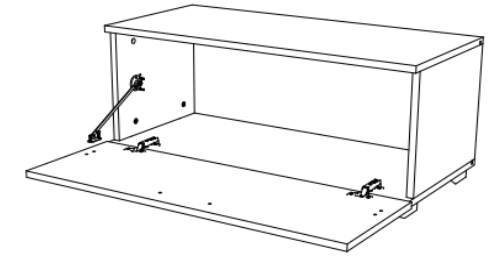

Kulplar '2' numaralı vida yardımıyla kapaklara monte edilir.

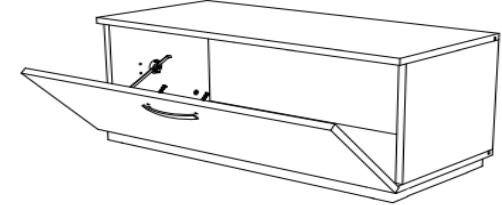

TRENDSTYLE ORTA MODÜL BAZALI

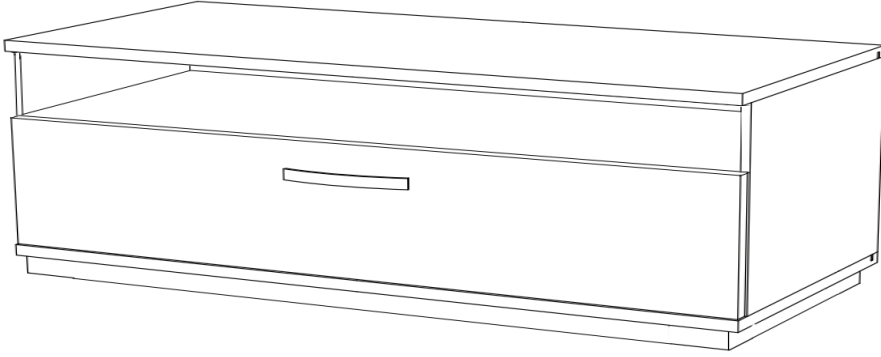

12x



3x

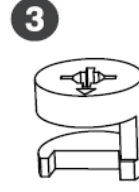

16x



16x



4x

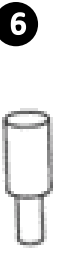

4x

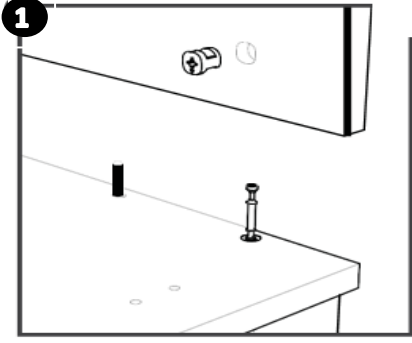

7 ve 8 numaralı baza parçaları 1 Numaralı parçanın alt yüzüne monte edilir.

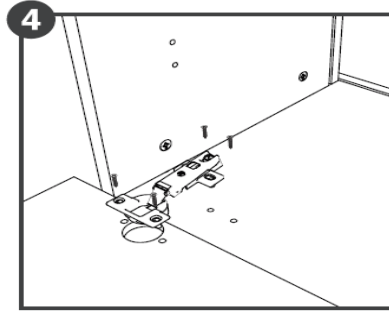
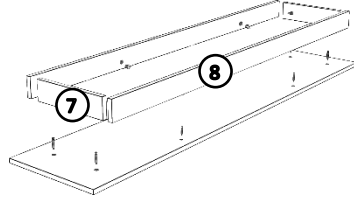

'1' numaralı vidalar yardımıyla menteşeler öncelikle kapaklara, sonrasında dolap gövdesine monte edilir.

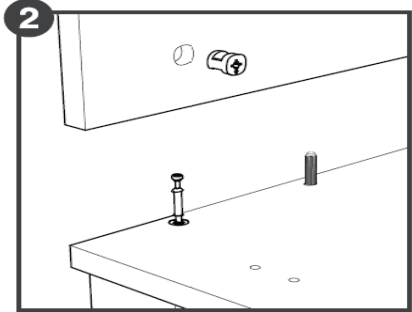
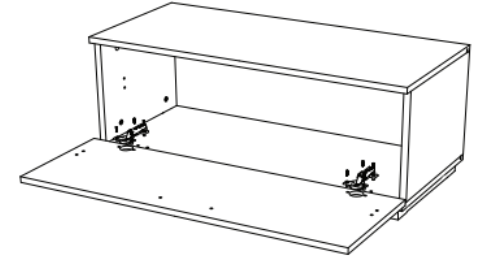

Aynı parçanın diğer yüzüne '4' numaralı minifix mili ve '5' numaralı kavilyalar takılarak '2-3' numaralı parçalar monte edilir. Daha sonra '3' numaralı minifix başı üzerindeki ok milin gireceği yönde olarak monte edilir. (Sağa doğru iyice çevrilerek kilitletir.)

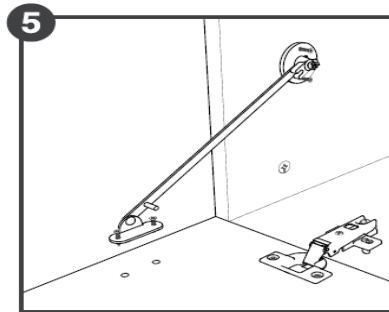
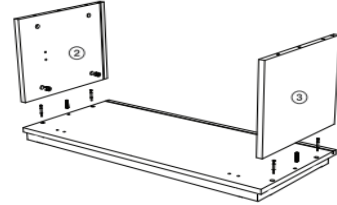

6 numaralı raf pimleri takıldıktan sonra 6 numaralı parça yerleştirilir.

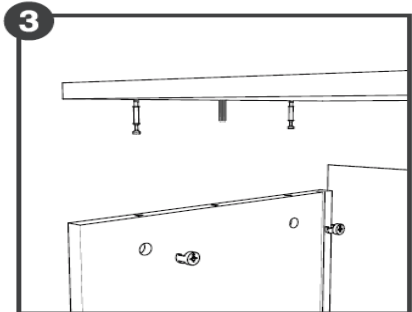
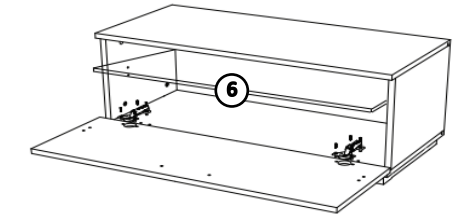

Arka parça yan ve alt parçadaki kanallara yerleştirilir. '4' numaralı parça monte edilir.

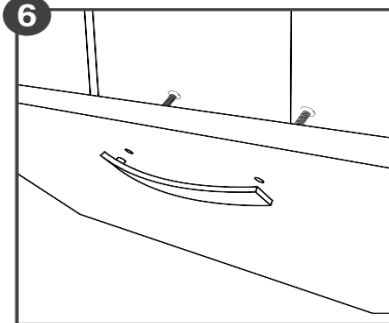
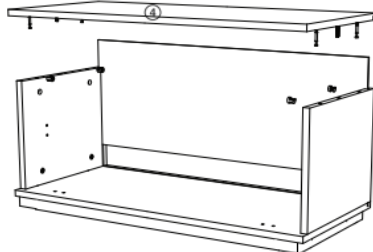

Kulplar '2' numaralı vida yardımıyla kapaklara monte edilir.

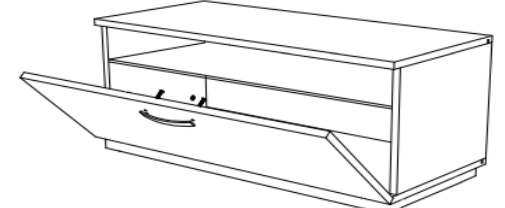

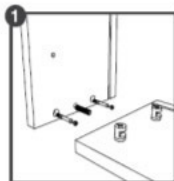
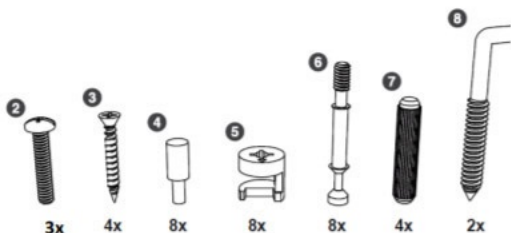
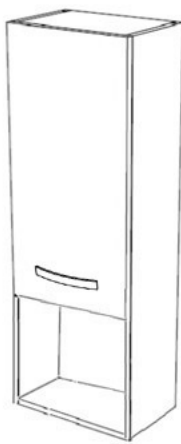

6 numaralı parçanın üzerindeki dört adet metal yuvaya 6 numaralı minifix mili ve 7 numaralı kavilyalar takılarak 5-8 numaralı parçalar monte edilir. Daha sonra 5 numaralı minifix başı üzerindeki ok milin greceği yönde olarak monte edilir (Sağa doğru lyce çevrilerek kilitlenir)

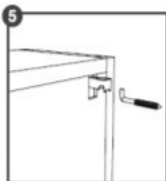

Ürün beraberinde verilen delik şablonundan faydalanılarak duvara 8 mm matkapla iki adet delik açıldıktan sonra 8 numaralı sk vidaların uçları en fazla 1 cm. dışarı çıkacak şekilde takılır. Dolap duvara asıldığı anda plastik aski elemanı üzerinde bulunan üstteki vida sağa doğru çevrildiğinde dolap duvara yapışır. Altta çapraz duran vida ise aşağı yukarı hareket sağlayarak dolap teraziye getirir.

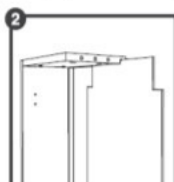

Arka parça beyaz yüzü dolap içine bakacak şekilde yukarı ve üst parçadaki kanallara yerleştirilir.

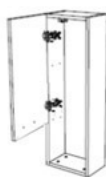
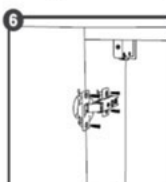

1 numaralı vidaların yardımıyla menteşeler iki parçaya ayrılmadan öncelikle kapaklara sonrasında dolap gövdesine monte edilir.

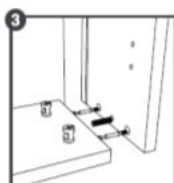

7 numaralı parça üzerindeki dört adet metal yuvaya 6 numaralı minifix mili ve 7 numaralı kavilyalar takılarak diğerleriyle birleştirilip, aynı yöntemle 5 numaralı minifix başı kullanılarak sabitlenir.



4 numaralı raf pimleri 6-7 numaralı parçalar üzerinde bulunan minik deliklere takıldıktan sonra raflar yerleştirilir.

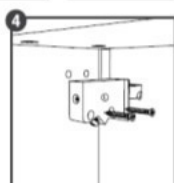

Plastik aski elemanı üzerinde L yazılı parça sola (6 numaralı parça) R yazılı parça sağa (7 numaralı parça) 3 numaralı vida kullanılarak metal kısmını dolap arkasına çıkacak şekilde monte edilir.

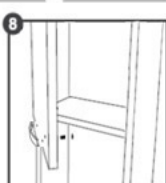

Kulpar 2 numaralı vidaların yardımı ile kapaklara monte edilir.