

MİNİMA RUBİS

KURULUM ŞEMASI

ASSEMBLY GUIDE

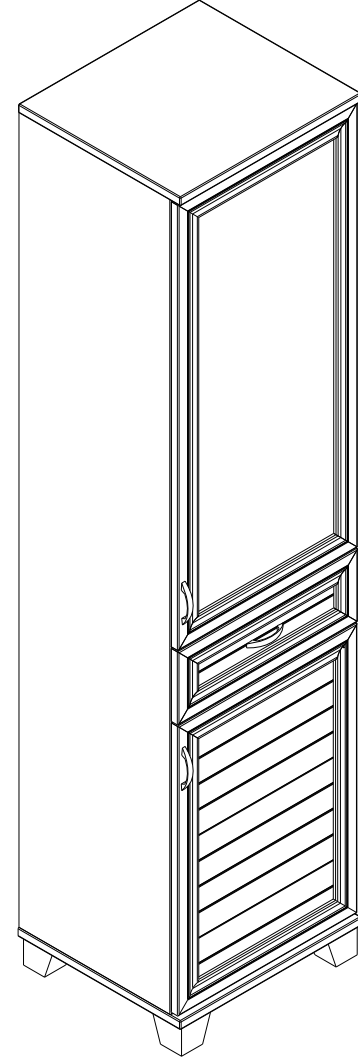

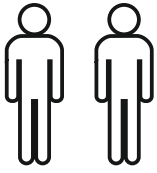

Bu modül iki kişi tarafından kurulmalıdır.
This unit should be assembled by two persons.



Bu modülün kurulumu için gerekli olan araçlar.
The necessary tools (not included)

AKSESUAR LİSTESİ / ACCESSORY LIST

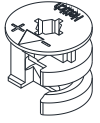

MINİFİX GÖVDE X 14
(MINIFIX BODY)

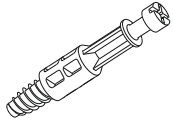

MINİFİX MİL X14
(MINIFIX SHAFT)

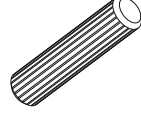

KAVELA X 14
(DOWEL)

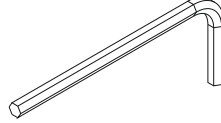

ALYAN ANAHTAR X 1
(KEY)

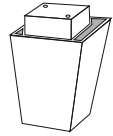

PLS. AYAK X 4
(PLASTIC FOOT)

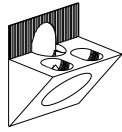

ARKALIK PİMİ X 10
(CORNER WEDGE)

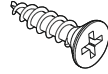

3,5 X 18 SUNTA VİDASI X 50
(3,5X18 SCREW)

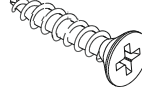

3.5 X 50 VİDA X 4
(3.5 X 50 SCREW)



METAL KULP X 3
(HOLDER)

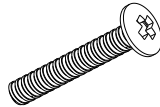

M4X22 KULP VİDASI X 6
(HOLDER SCREW)

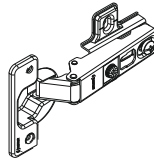

DÜZ MENTEŞE X 4
(HINGE)

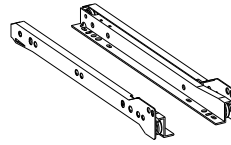

30 CM ÇEKMECE RAY X1 TK.
(RAİL)

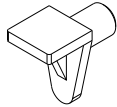

RAF PİMİ X 12
(PLASTIC PIN)



DÜBEL X 14
(PEG)

* AKSESUARLARI GÖSTERİLDİĞİ GİBİ DÜZ BİR ZEMİN ÜZERİNDE TAKINIZ...

* ÜRÜNÜ KURARKEN MONTAJ SIRASINI TAKİP EDİNİZ

* FIX THE ACCESORIES AS SHOWN FOLLOW THE INSTALLATION SEQUENCE WHILE INSTALLING THE PRODUCT.

1

DİKKAT !! / ATTENTION !!

Minifiks ve Kavela ürünlerimizde kullanılan ana bağlantı malzemesidir. Montaja başlamadan önce lütfen aşağıdaki çizimleri kontrol ederek, anlamaya çalışın...

Minifix and Dowel is the main connection material used in products. Before starting assembly, please check the drawings below...

Minifix Dübeli (PEG)

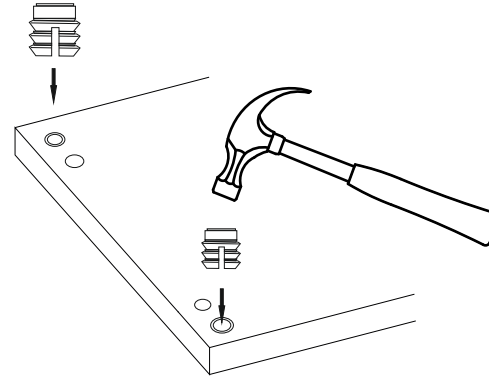

Minifix Gövde
(MINIFIX BODY)



Minifix Mil
(MINIFIX SHAFT)

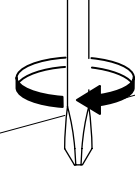
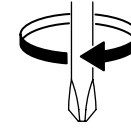
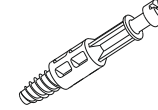

Kavela
(DOWEL)

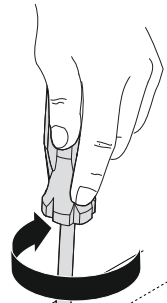

2

PARÇA KODLAMA / GENERAL VIEW

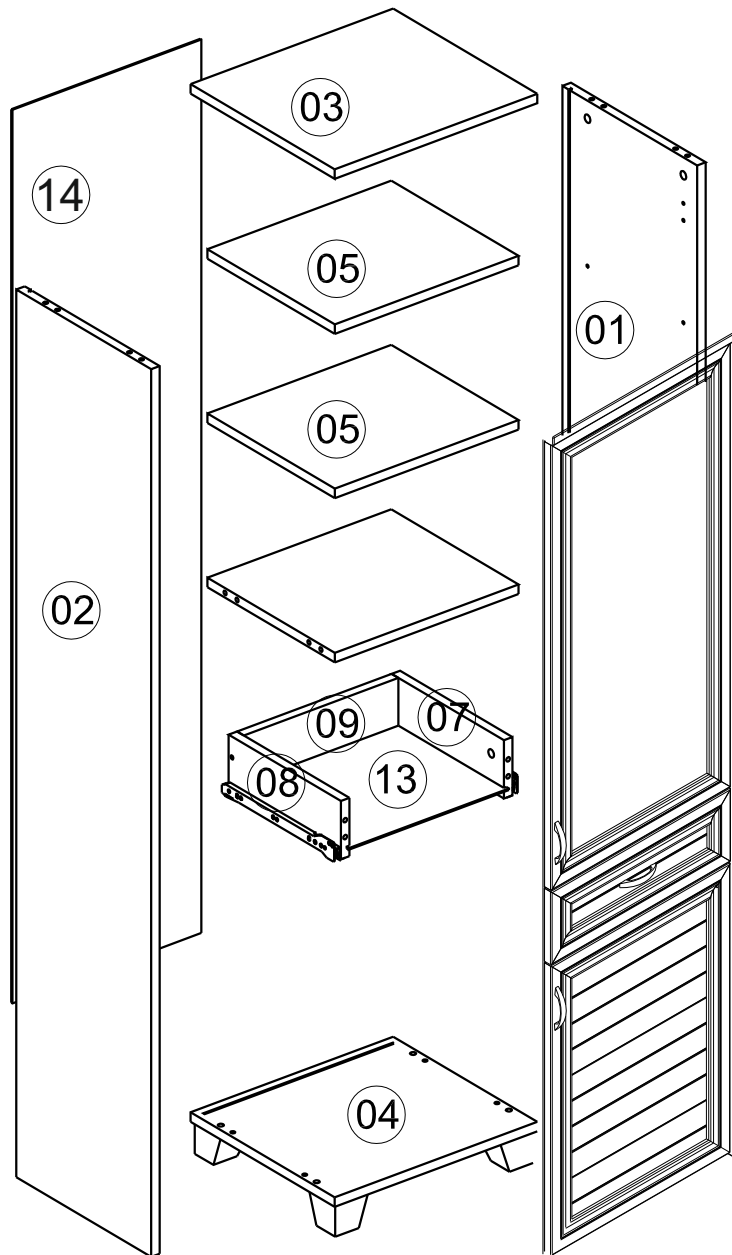

3

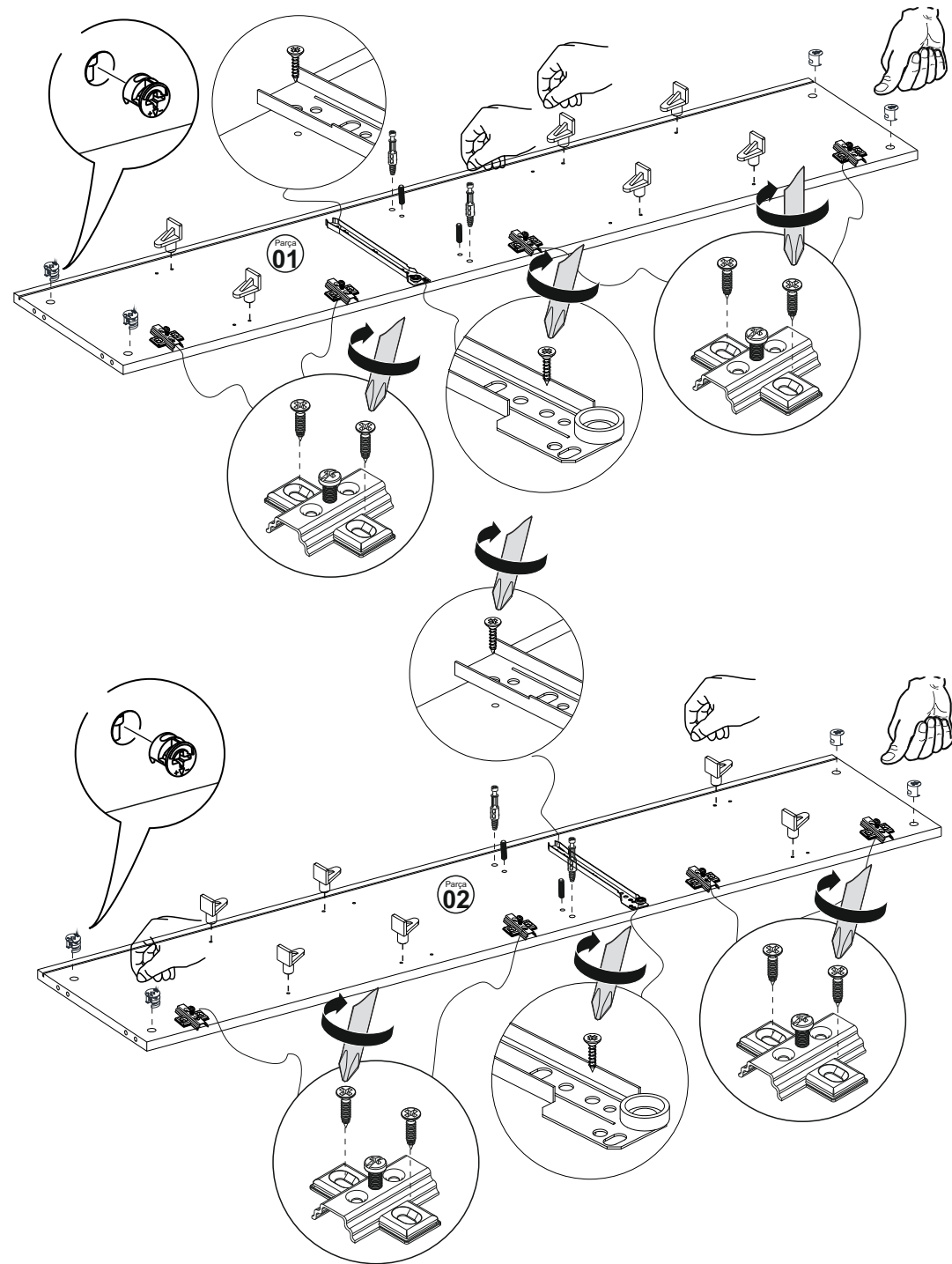

4

