







01	720x550x18 mm	x2	04	120x597x18 mm	x1
02	564x550x18 mm	x2	05	610x600x28 mm	x1
03	120x600x3 mm	x1			

A1 	A2 	A3 	B1 3,5x18 	B12 4x30 	B9 3,5x30 	D1 	E1 
12x	12x	12x	19x	2x	8x	10x	2x



4

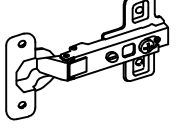
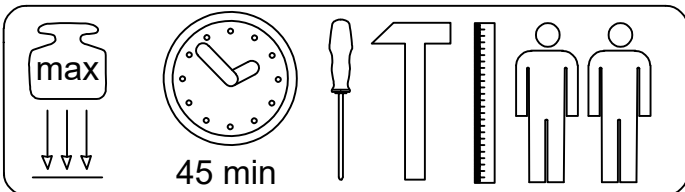
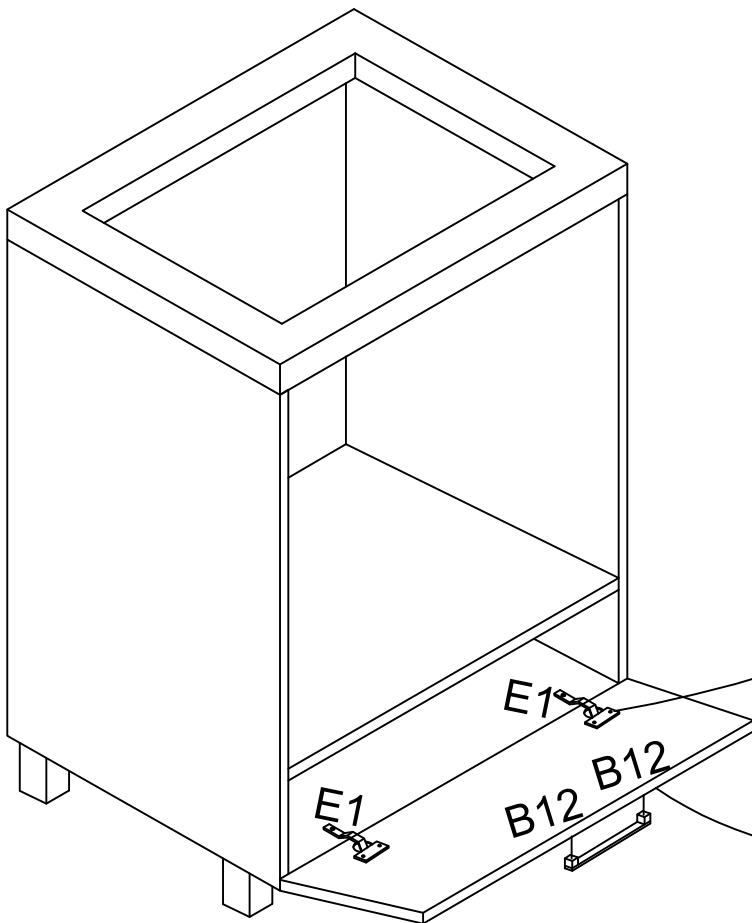

04

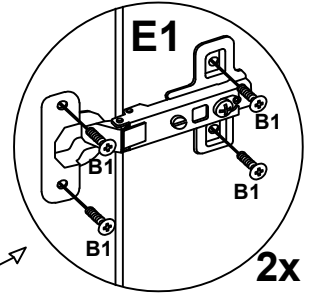

2x

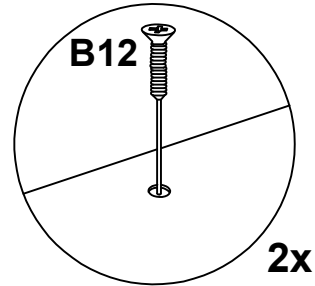

2x

5

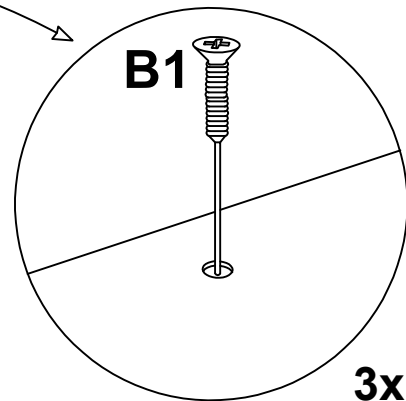
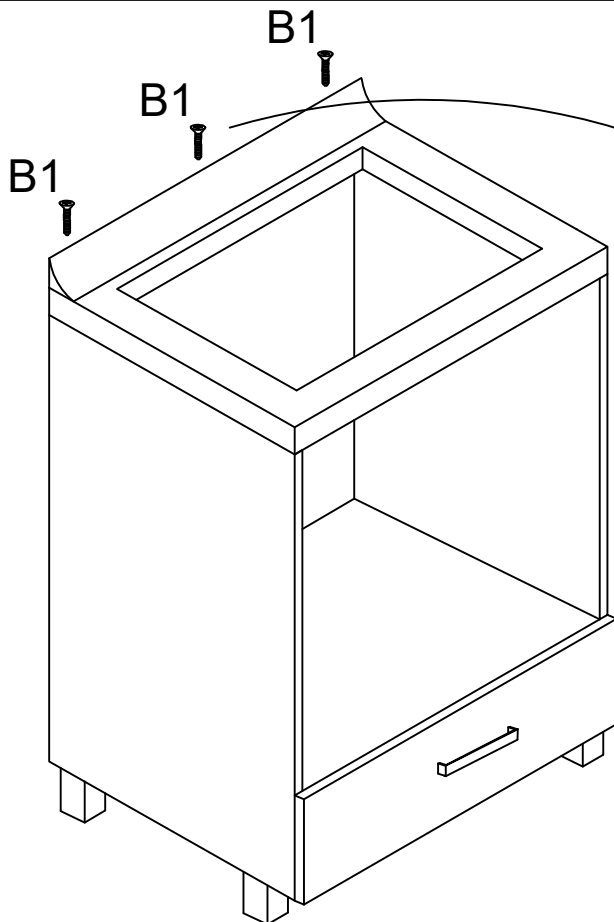

3x