







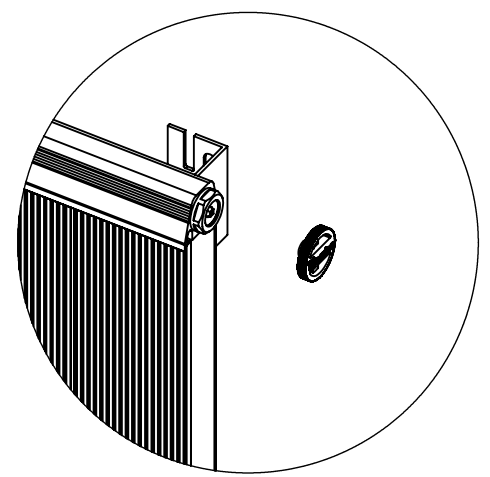

Key	Component	Qty
	<b>A</b> Bleeding Valve Key	<b>1</b>
	<b>B</b> Bleeding Valve 1/2 "	<b>1</b>
	<b>C</b> Blind Tap	<b>1</b>
	<b>D</b> Friction Cups/Cushions	<b>4</b>
	<b>E</b> Left Bracket	<b>2</b>
	<b>F</b> Right Bracket	<b>2</b>
	<b>G</b> Screw-5,5x45mm	<b>8</b>
	<b>H</b> Wall Plug	<b>8</b>



**Assembly Instructions**

- Fit bleeding valve (B) & blind tap (C).
- Use Carisa bleeding valve key (A) to turn bleeding valve (B).
- Accurately mark out bracket holes on wall using spirit level.
- Drill four 8mm diameter holes for upper brackets (E) and four 8mm diameter holes for bottom brackets(F).
- Friction cups (D) **MUST** be fitted to each mounting brackets (E,F) to suppress potential noise.
- Screw brackets (E,F) into wall plugs (H) with 5,5mm diameter x 45mm screws (G).
- Hang radiator by sliding the bosses on the back of the radiator into brackets (E,F).