





Key	Component	Qty
 A	Bleeding Valve Key	1
 B	Bleeding Valve 1/2 "	1
 C	Blind Tap	1
 D	Friction Cups/Cushions	4
 E	Left Bracket	2
 F	Right Bracket	2
 G	Screw-5,5x45mm	8
 H	Wall Plug	8



### Assembly Instructions

Fit bleending valve (B) & blind tap (C).

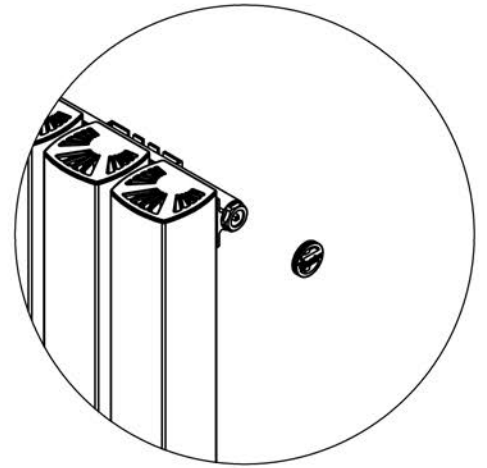
Use Carisa bleeding valve key (A) to turn bleeding valve (B).

Accurately mark out bracket holes on wall using spirit level.

Drill four 8mm diameter holes for upper brackets (E) and four 8mm diameter holes for bottom brackets(F).

Friction cups (D) **MUST** be fitted to each mounting brackets (E,F) to suppress potential noise.

Screw brackets (E,F) into wall plugs (H) with 5,5mm diameter x 45mm screws (G).

Hang radiator by sliding the bosses on the back of the radiator into brackets (E,F).

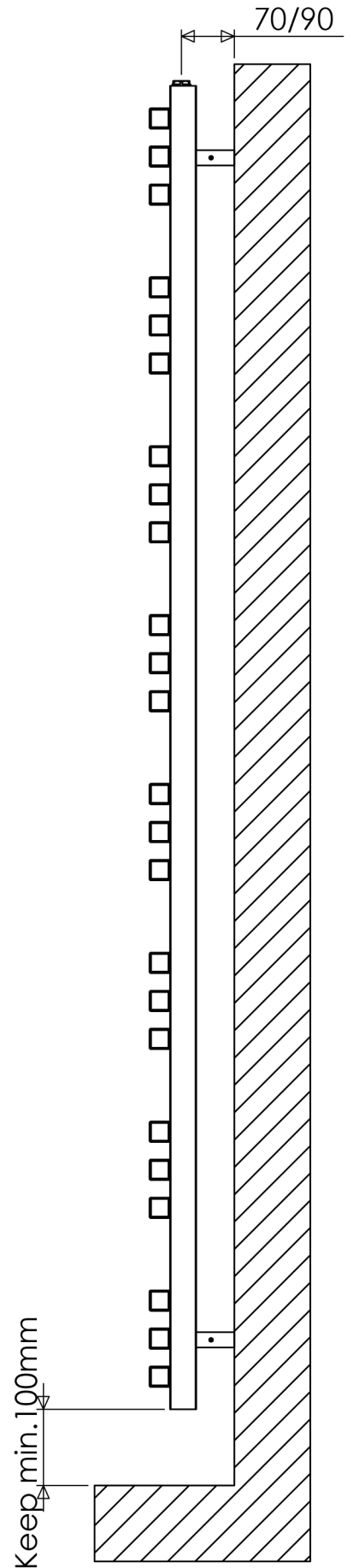
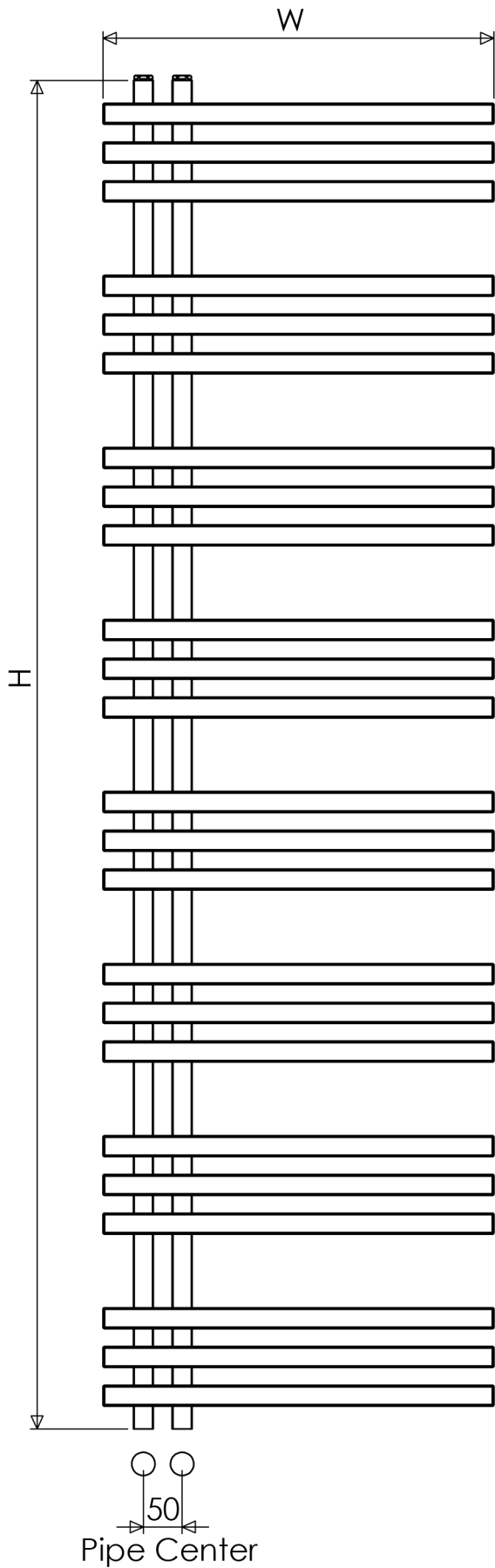

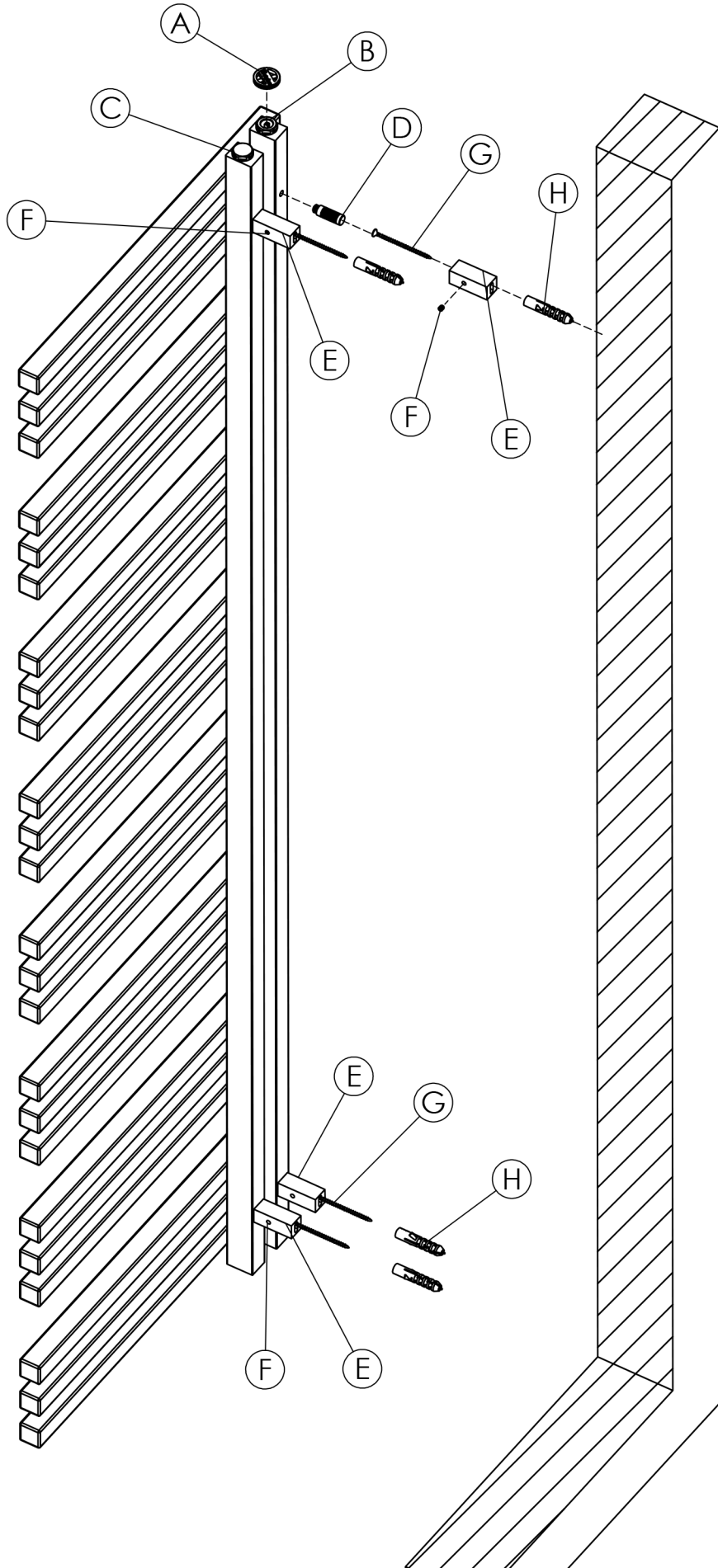

Key	Component	Qty
	<b>A</b> Bleeding Valve Key	1
	<b>B</b> Bleeding Valve 1/2"	1
	<b>C</b> Blind Tap	1
	<b>D</b> Stud	4
	<b>E</b> Square Wall	4
	<b>F</b> Grub Screw	4
	<b>G</b> Screw-5,5x45mm	4
	<b>H</b> Wall Plug	4

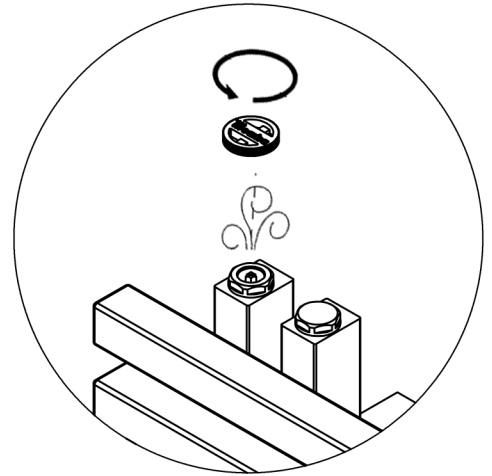

### Assembly Instructions

Fit bleeding valve (B) & blind tap (C).

Use Carisa bleeding valve key (A) to turn bleeding valve on final installation(B).

Accurately mark out bracket holes on wall using spirit level.

Drill four 8mm hole for each brackets (E).

Screw brackets (E) into wall plugs (H) with 5,5mm diameter x 45mm screws (G).

Assemble the studs (D) into the holes which on back of the collector.

Hang radiator by centering the studs (D) into the brackets (E).

Secure the stud (D) with the grub screw (F) after setting wall distance.