

MONTAJ VE KULLANIM KILAVUZU ASSEMBLY MANUEL

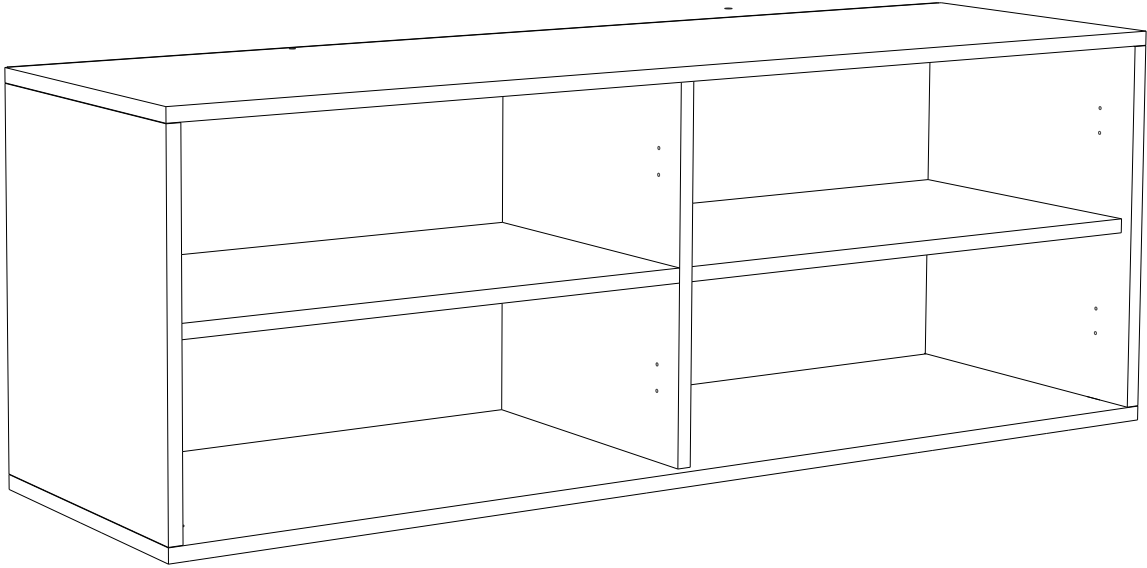









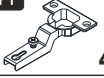

SAYFA 2

This unit should be assembled by two persons
Bu modül iki kişi tarafından kurulmalıdır.

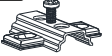

MONTAJ LİSTESİ / Mounting List

Bu modülün kurulumu için gerekli olan araçlar.
The necessary tools (not included)

| | | | | | | | | |
|--|---|--|--|--|--|---|--|--|
| A01 Minifix Gövde  6x | A02 Minifix Mil  6x | A41 Yarım deve menteşe  4x | A04 Minifix Tapa  Değişken 6x | A10 3,5x18 YHB Vida  32x | A03 Kavela  6x | A12 Düz Menteşe  4x | A13 Menteşe Atlığı  8x | A40 RAF PİMİ  8x |
| A09 4x50 YHB Vida  6x | A28 Arkalık Çivisi  48x | | | | | | | |

PARÇA KODLAMA / GENERAL VIEW

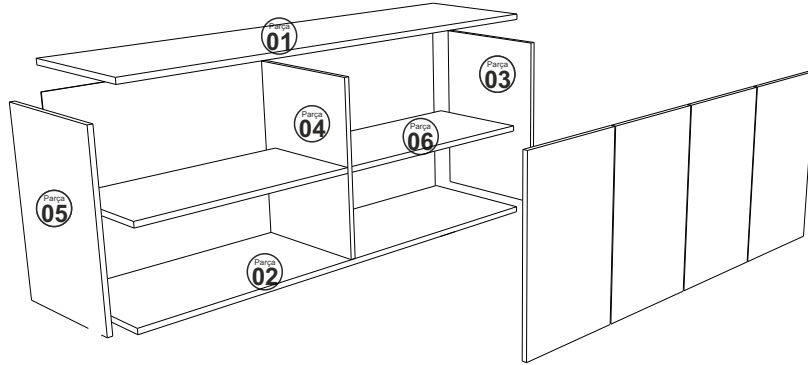

SAYFA 3

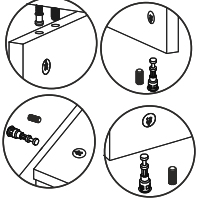

A02

Minifix Mil

A01

Minifix Gövde

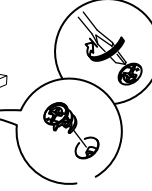
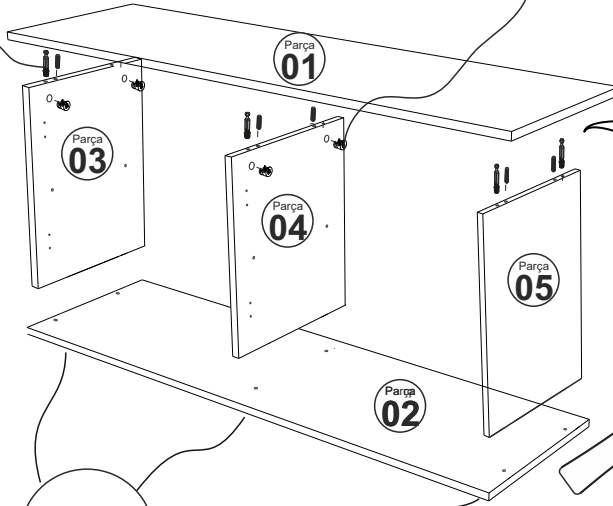

A28

Arkalık Çivisi

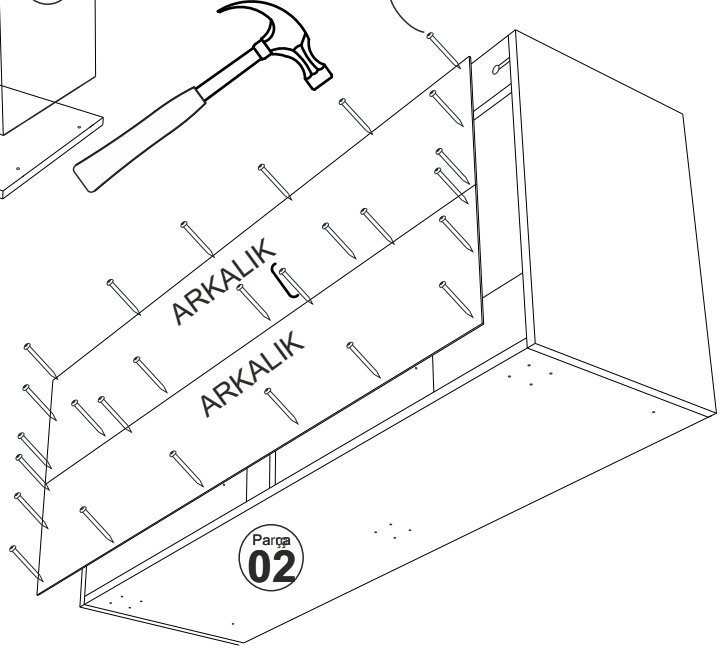

A09

4x50 YH8 Vidâ

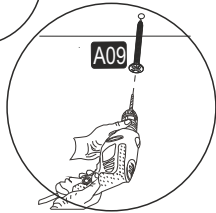

SAYFA 4

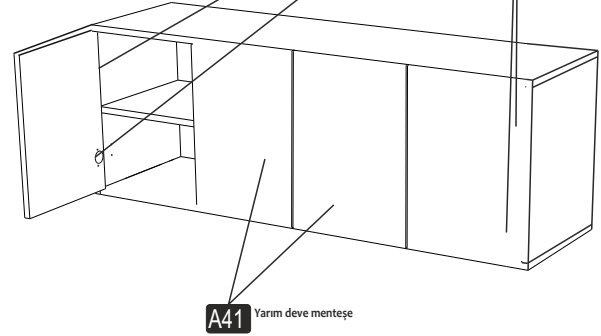
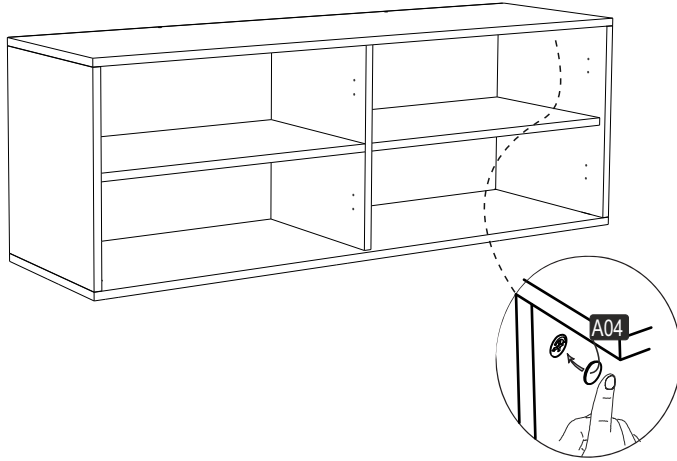
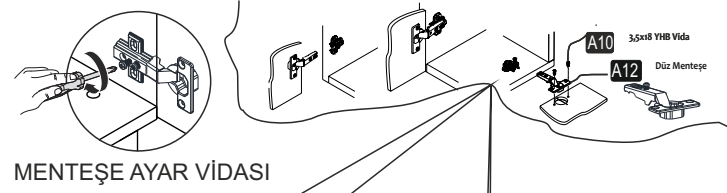
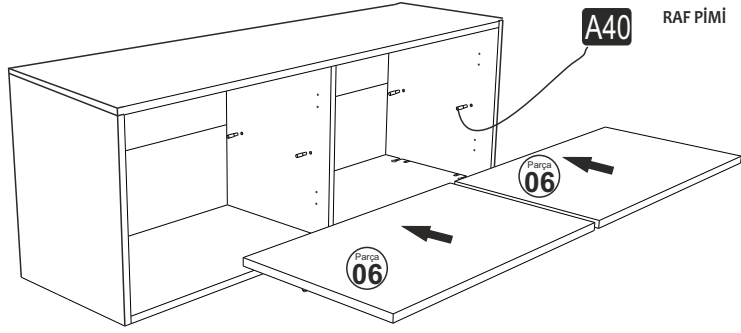

SAYFA 5

KNS8108





This unit should be assembled by two persons
Bu modül iki kişi tarafından kurulmalıdır.

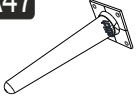

ARNO KONSOL-KB150

AKSESUAR LİSTESİ / Accessory List

Bu modülün kurulumu için gerekli olan araçlar.
The necessary tools (not included)

| | | | |
|---|--|---|---|
| A47 Bone Ayak  5x | A10 3,5x18 YHB Vida  20x | A45 İKİTOP KULP  | A14 M4x22 Kulp Vidası  8x |
|---|--|---|---|

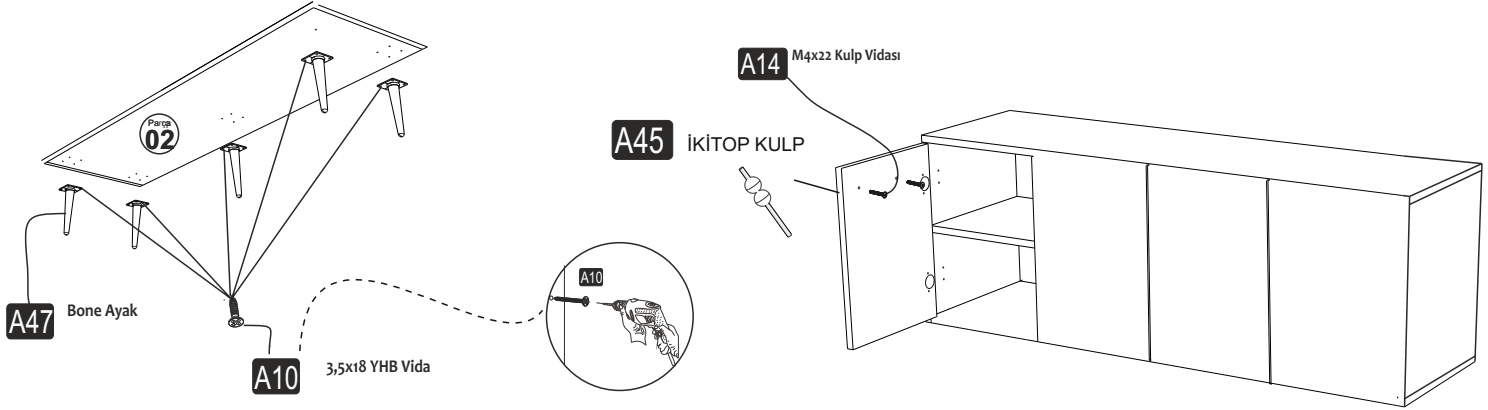

YATAY POZİSYONDA AYAK
MONTAJINI YAPALIM.



ÖRÜNÜ İKİ KİŞİ HAVAYA KALDIRALIM.



HAVAYA KALDIRDIĞIMIZ ÖRÜNÜ
DİKEY POZİSYONA GETİRELİM.

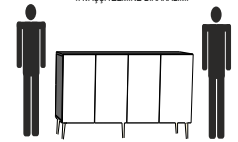

YAYAŞA ZEMİNE BIRAKALIM.

ATTENTION !!

Minifix is the main connection material used in products. Before starting assembly, please check the drawings below.

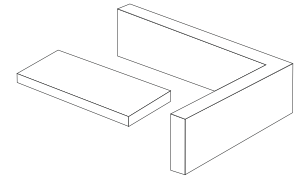
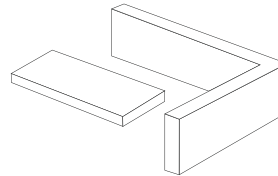
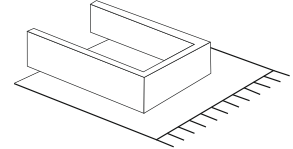
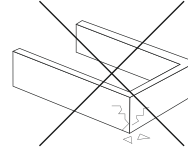
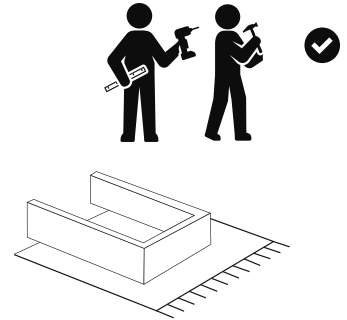
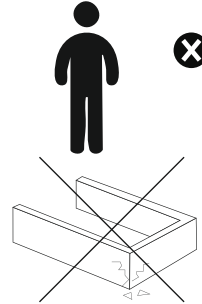
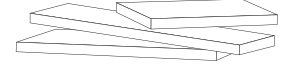
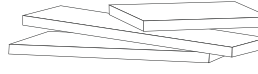
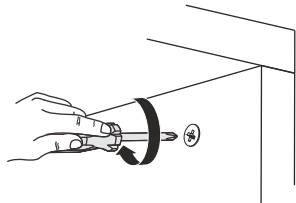
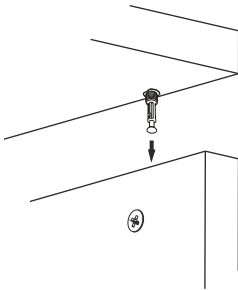
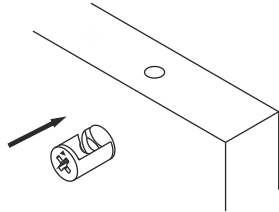
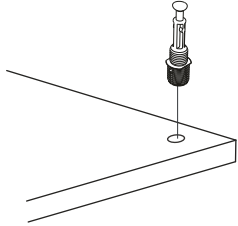
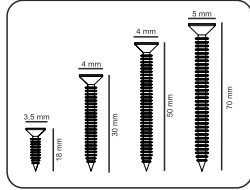
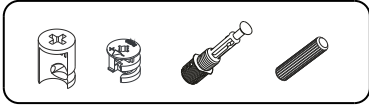



Dear Customer,

We are delighted to meet your needs and hope you enjoy our products. May they bring joy to you and your family. Please be assured that this product has successfully passed all safety and health tests.

Thank you for choosing us!

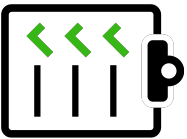

Assembly Recommendations

We kindly recommend checking the components and accessories listed in the installation guide before beginning assembly.

If you have purchased multiple products (we're happy to hear that!), we suggest completing the assembly of the first product before moving on to the second.



We recommend that you clean all parts with a slightly damp cloth before assembling the product.

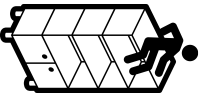

Safety Instructions

Please avoid using the products for purposes other than their intended use. It is crucial for the safety and well-being of you and your family to prevent any risk of injury.

To ensure the longevity of the product, please keep it away from excessive heat, cold, and humidity.

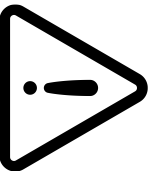

WARNING!

Securing the furniture to the wall is highly recommended for your safety. Furniture tips over can result in serious injuries or even fatal accidents. To prevent such risks, please ensure your furniture is securely fixed to the wall.

Please note that fixing devices are not included in the package, as different wall types require different solutions. Use suitable fixing devices that you trust. If you are unsure which devices to use, we recommend consulting our local dealer for guidance.

