

BORA ŐÖMİNELİ TV ÜNİTESİ

MONTAJ VE KULLANIM KLAVUZU ASSEMBLY MANUEL

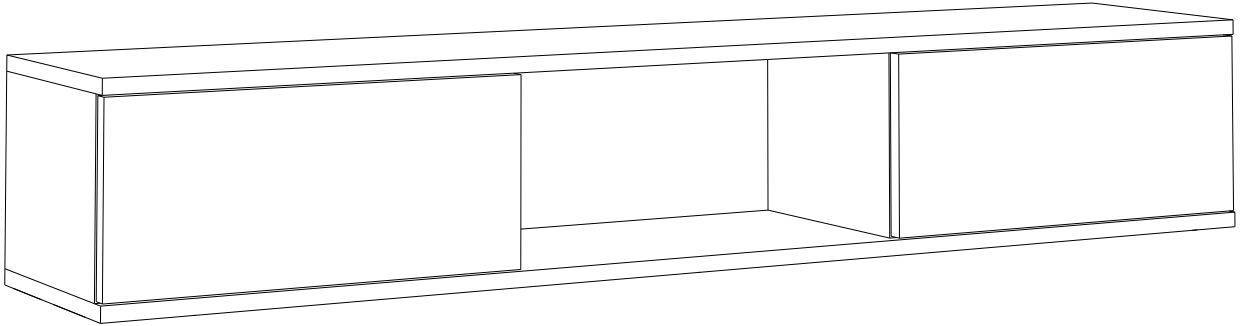





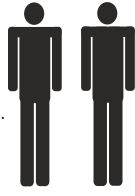



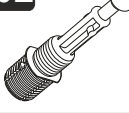

SAYFA 2

Bu modül iki kişi tarafından kurulmalıdır.
This unit should be assembled by two persons.

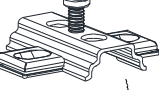

AKSESUAR LİSTESİ / Accessory List

Bu modülün kurulumu için gerekli olan araçlar.
The necessary tools (not included)

A01 Minifix Gövde  16x	A02 Minifix Mil  16x	A04 Minifix Tapa  16x	A10 3,5x18 YHB Vida  41x	A28 Arkalık Çivisi  30x
V23 AYAK  5x	A11 Tam Deve Boynu Menteşe  4x	A13 Minifix Atlığı  4x	A41 Üçgen kulp (siyah)  2x	A14 M4x22 Kulp Vidası  2x
A55 ŞÖMİNE  1x				

PARÇA KODLAMA / GENERAL VIEW

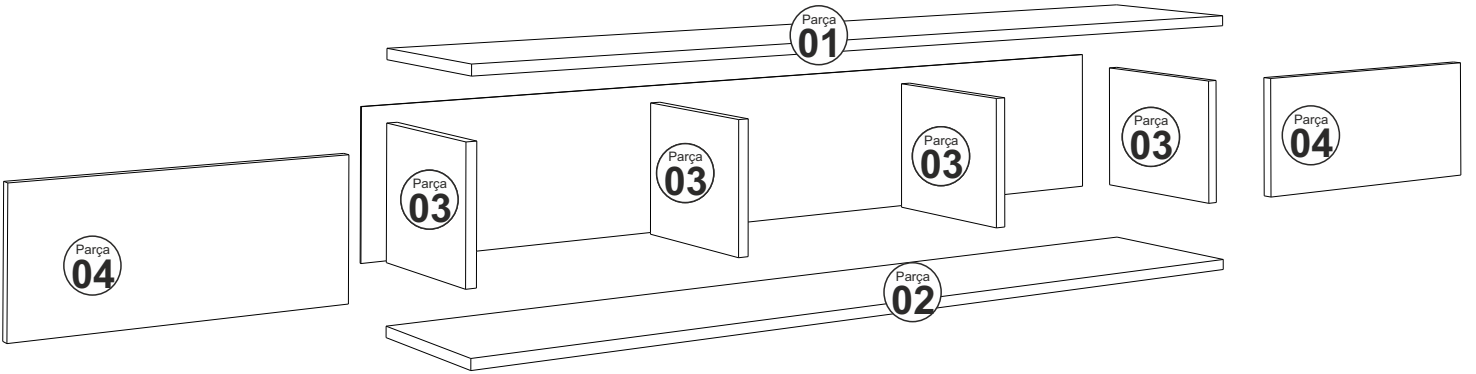

SAYFA 3

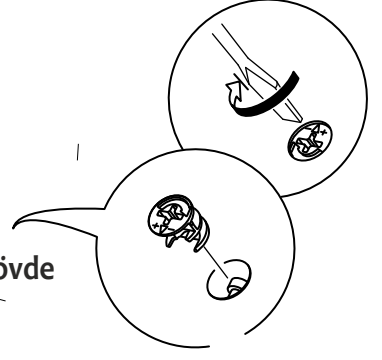
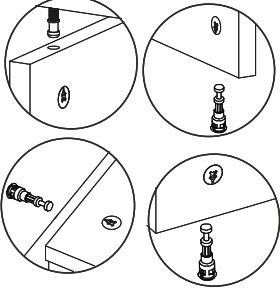

A02

Minifix Mil

A01

Minifix Gövde

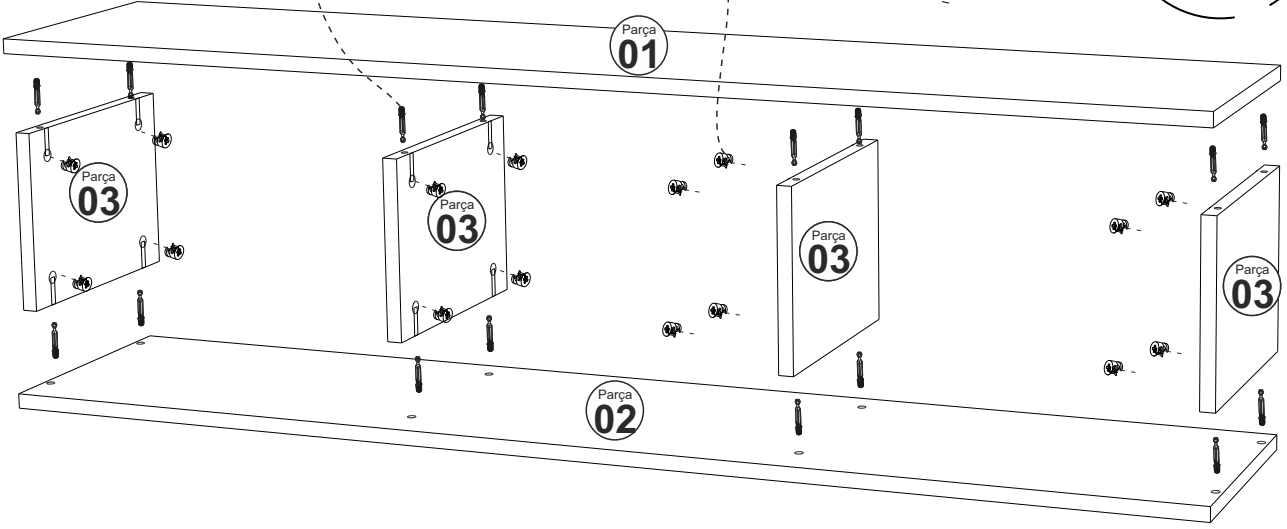

A28

Arkalık Çivisi

arkalık

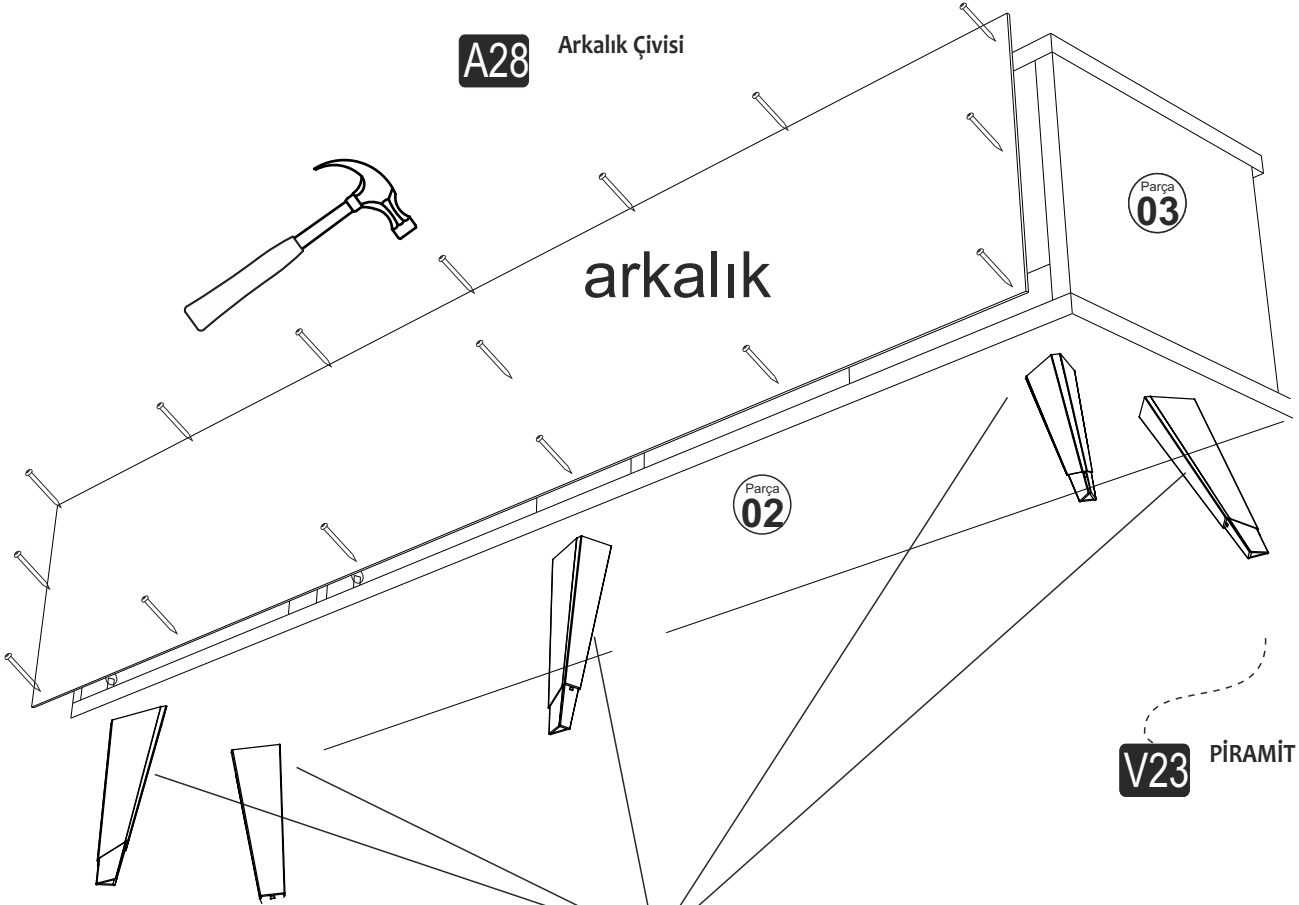

V23

PİRAMİT ayak

A20

3,5x18 YHB vida

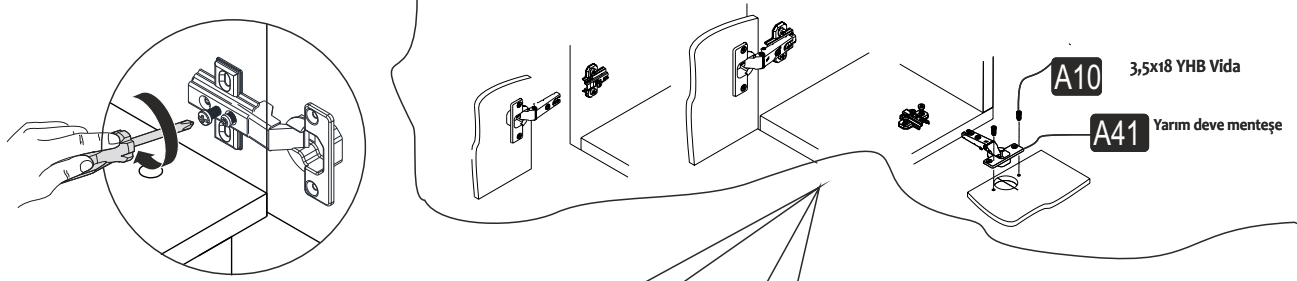

A10 3,5x18 YHB Vida

A41 Yarım deve menteşe

MENTEŞE AYAR VİDASI

A14 M4x22 Kulp Vidası

Parça 03

Parça 04

Parça 03

Parça 03

Parça 01

Parça 02

Parça 03

A41 Üçgen kulp (siyah)

Parça 04

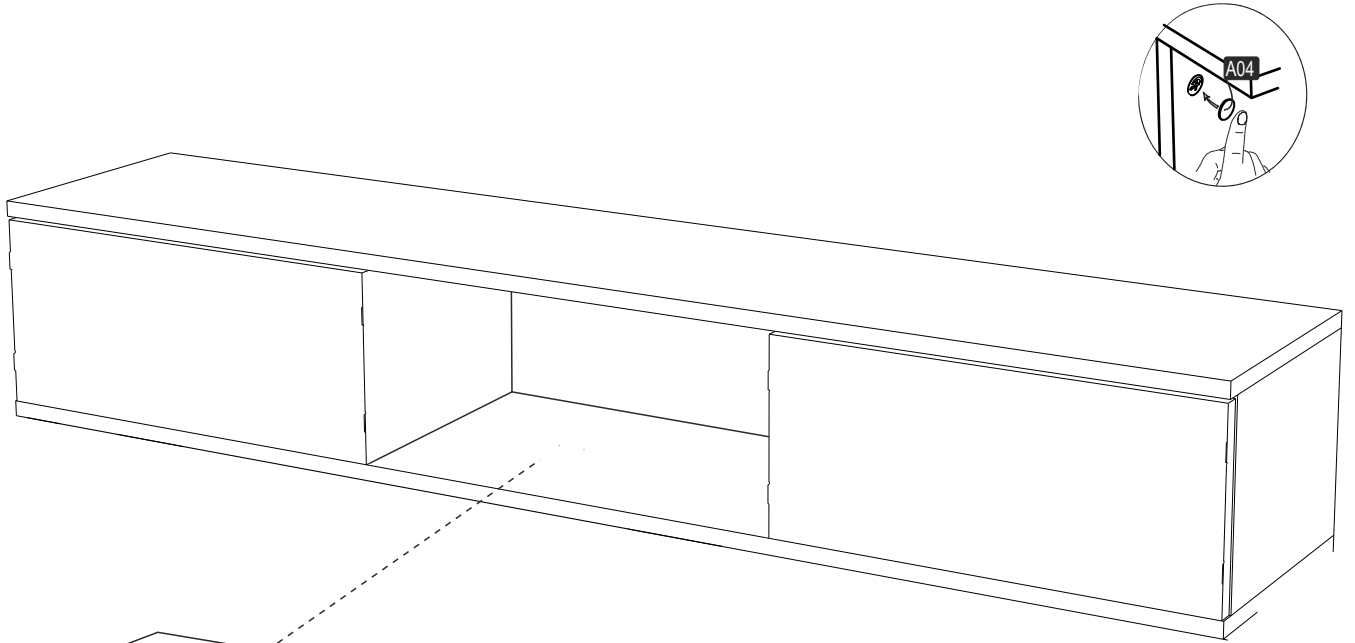

A04

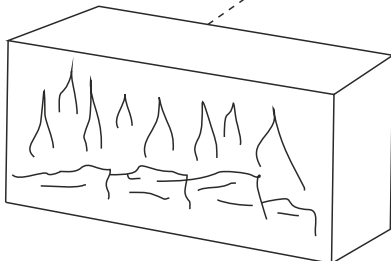

ŞÖMİNE