

# SİNTA KONSOL

---

## MONTAJ VE KULLANIM KLAVUZU ASSEMBLY MANUEL

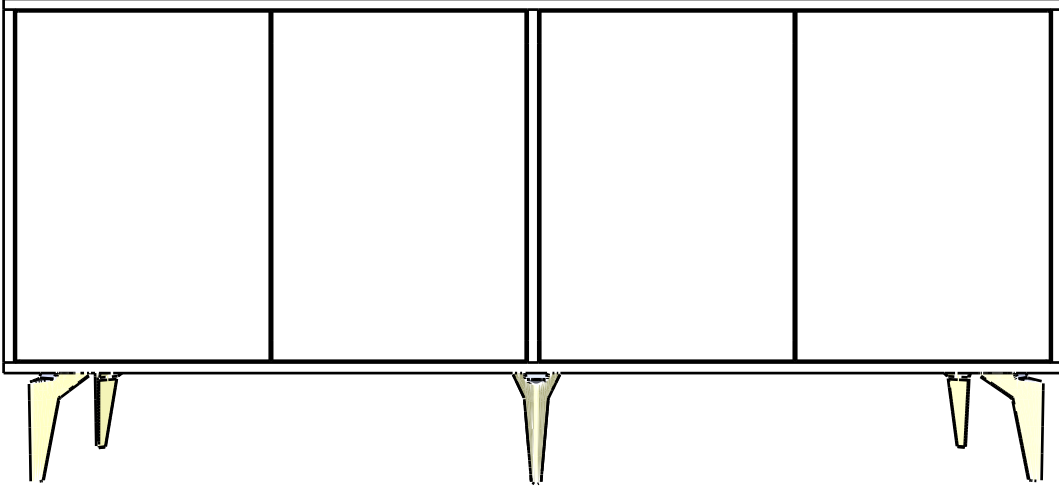





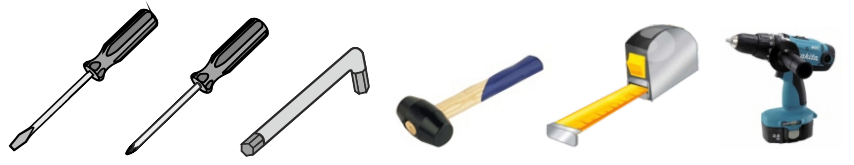
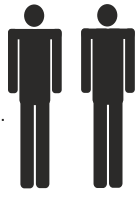

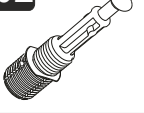
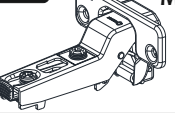

# SAYFA 2

Bu modül iki kişi tarafından kurulmalıdır.  
This unit should be assembled by two persons.

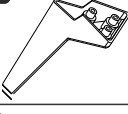

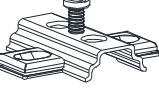
## AKSESUAR LİSTESİ / Accessory List

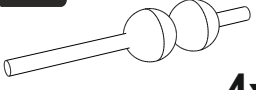
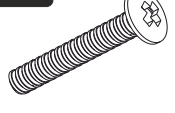
Bu modülün kurulumu için gerekli olan araçlar.  
The necessary tools (not included)

<b>A01</b> Minifix Gövde  6x	<b>A02</b> Minifix Mil  6x	<b>A11</b> Tam Deve Boynu Menteşe  8x	<b>A04</b> Minifix Tapa Değişken  6x	<b>A10</b> 3,5x18 YHB Vida  32x
<b>A52</b> ELEGANS AYAK  5x	<b>A04</b> KVLVY 8x30  6x	<b>A13</b> Menteşe Atlığı  8x	<b>A40</b> RAF PİMİ  8x	<b>A28</b> Arkalık Çivisi  36x
<b>A55</b> KULP  4x	<b>A14</b> M4x22 Kulp Vidası  8x	<b>A29</b> 3,5x30 YHB vida AYAK MOTAJİ İÇİN  15x	<b>A09</b> 4x50 YHB Vida  6x	

## PARÇA KODLAMA / GENERAL VIEW

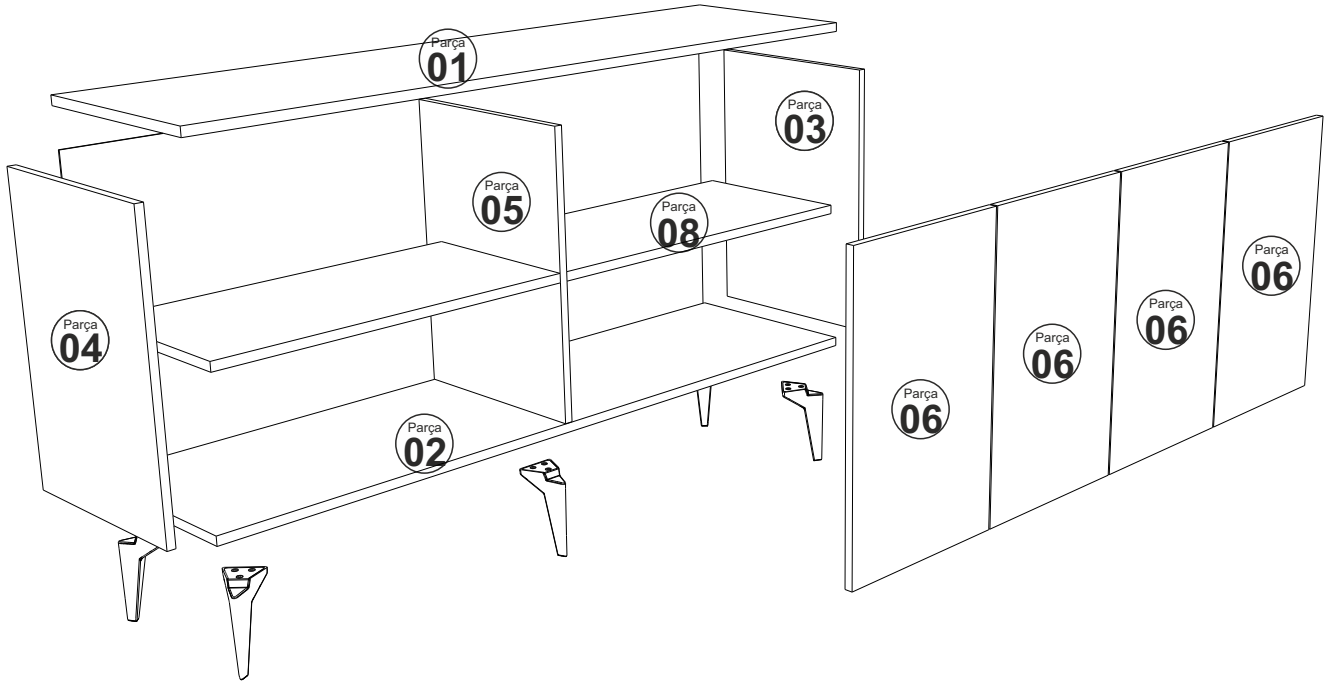

# SAYFA 3

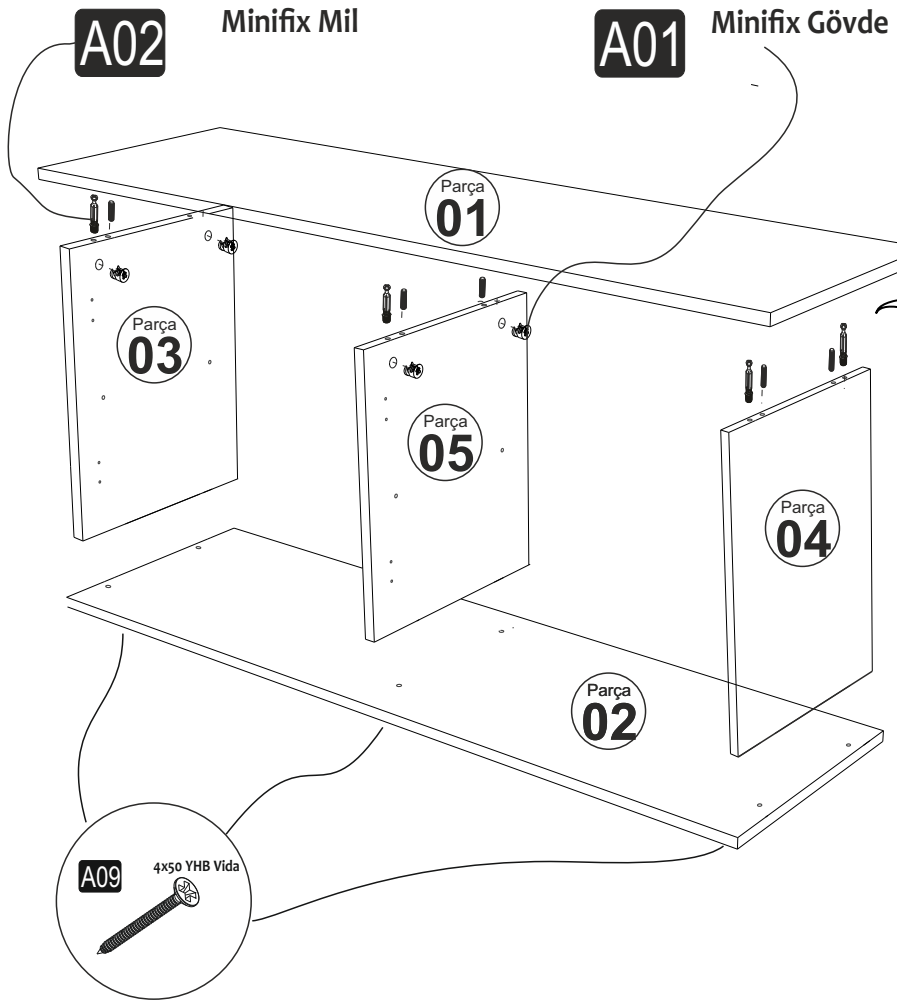
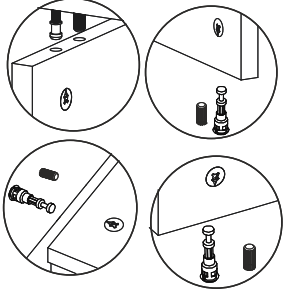

## **A28** Arkalık Çivisi

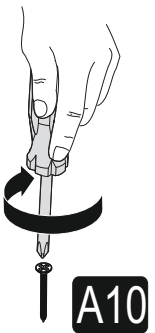
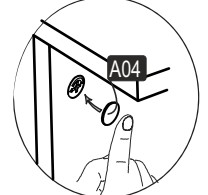
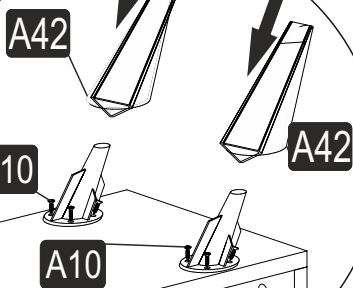
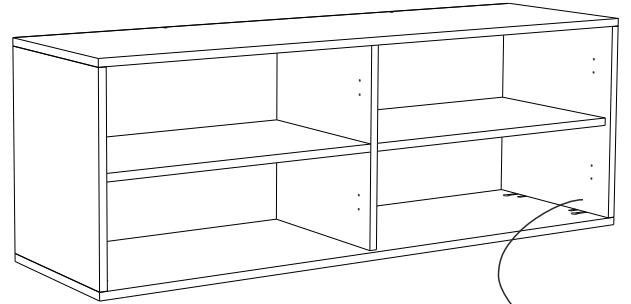
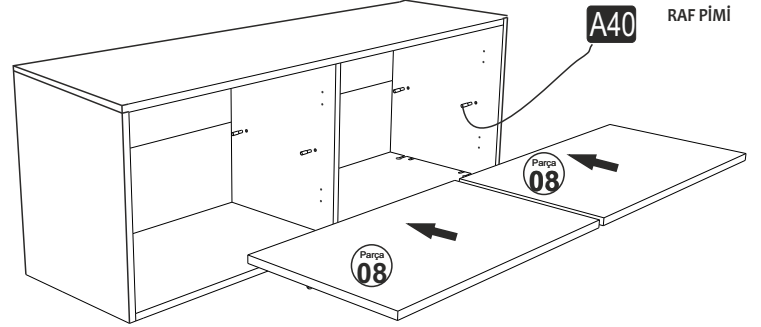
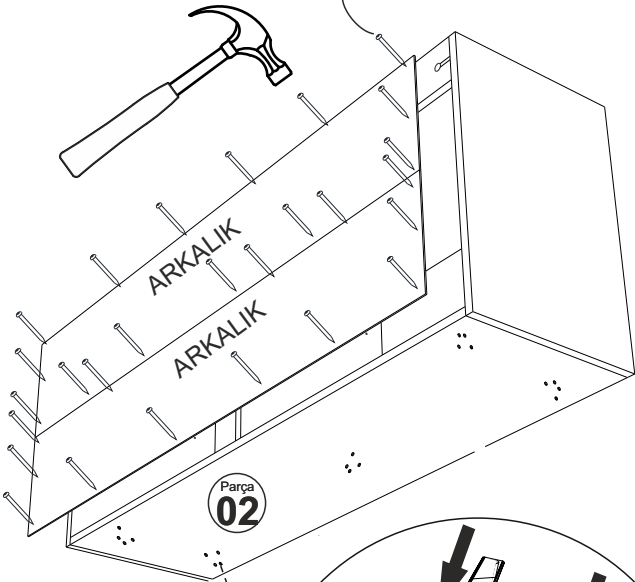

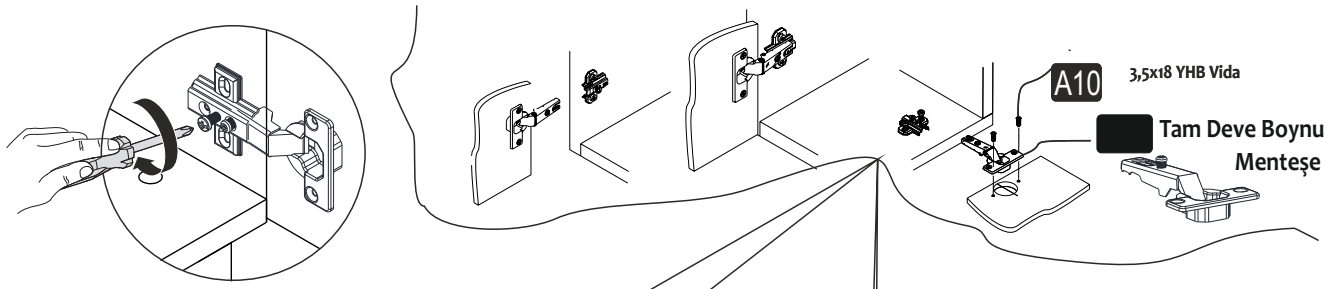

## MENTEŞE AYAR VİDASI

