

CLARK KİTAPLIK

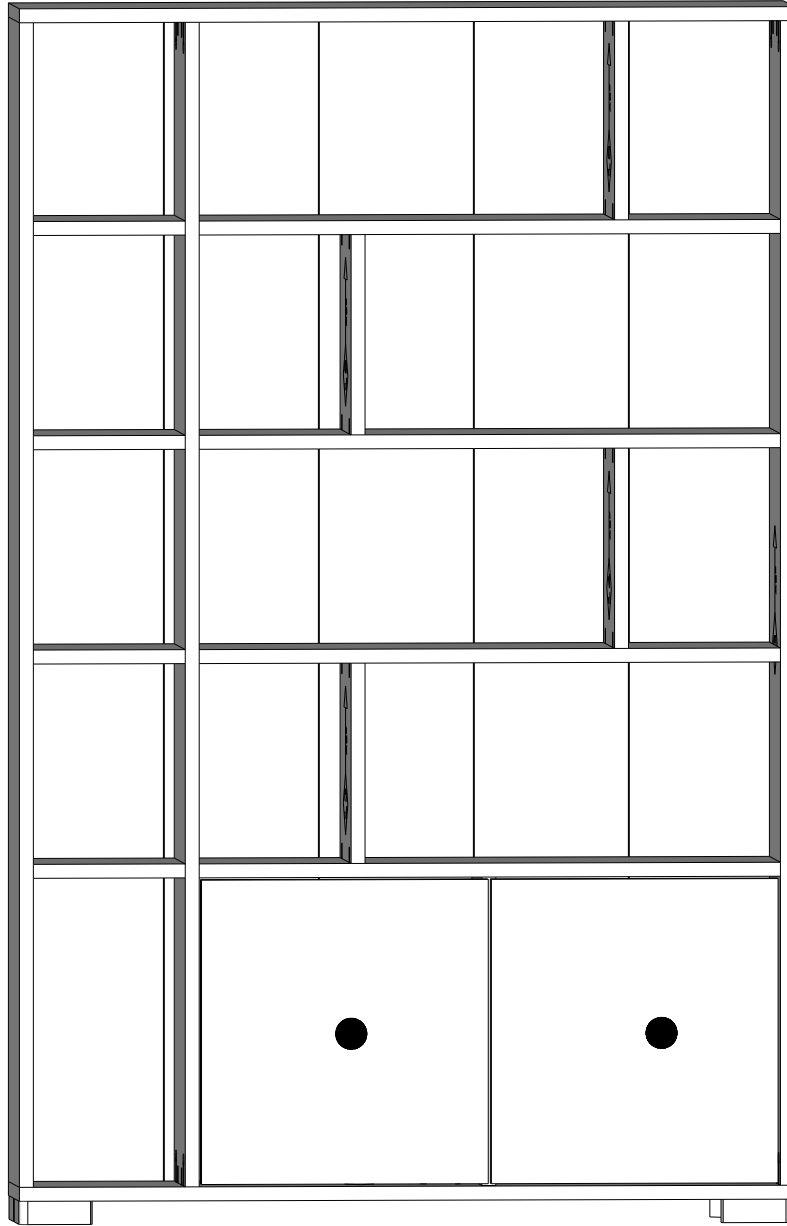

Dear Customer,

We design and produce our products for people to love and have fun with them as we do.

The product you bought was subjected to all sorts of tests and control before sending out to you.

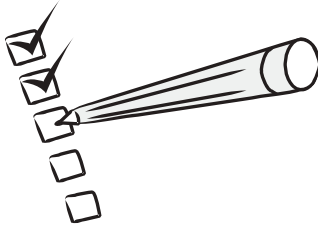

Before start assembling, please check the whole components and accessories according to the lists. If you bought more than one product, to prevent confusion be sure that you completed the first product. Then start the other product's assembling.

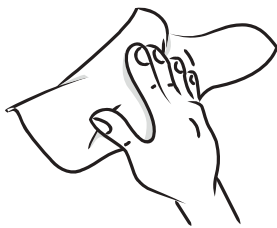

Before start assembling, please clean all the components with a damp cloth. Also for usual cleaning, this will be enough.



Although all the products are produced and packed carefully, sometimes happen that some component is damaged during the transportation. In such a case please check the missing or damaged part and do not hesitate to contact us. You can send e-mail to info@gmail.com or reach us at 0090 000 000 00 00

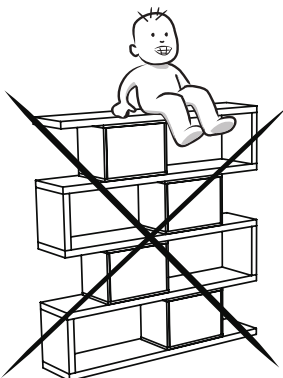

Do not use your furniture for out of purposes. If you would like to use it, please contact us for further questions.

Do not directly contact your furniture with excessive heat, cold and humidity because the product can be affected..

ATTENTION !!

Minifix is the main connection material used in products. Before starting assembly, please check the drawings below.

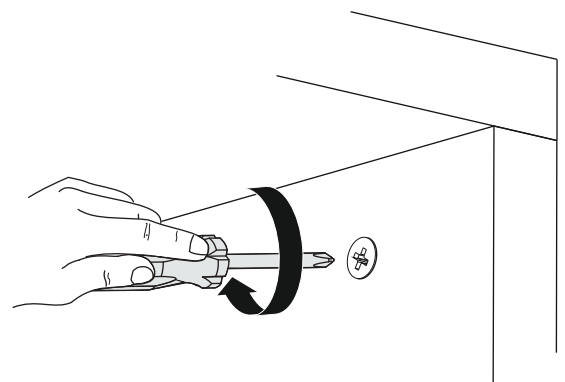
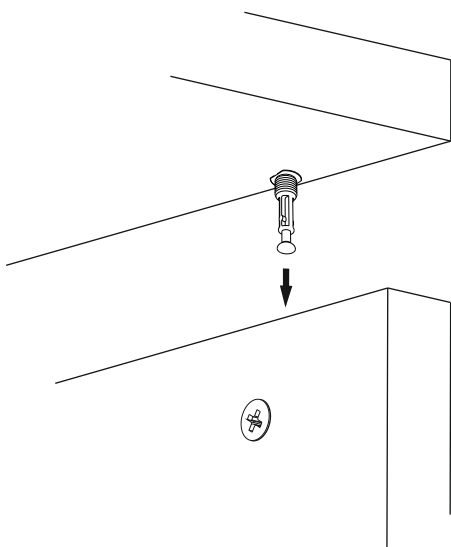
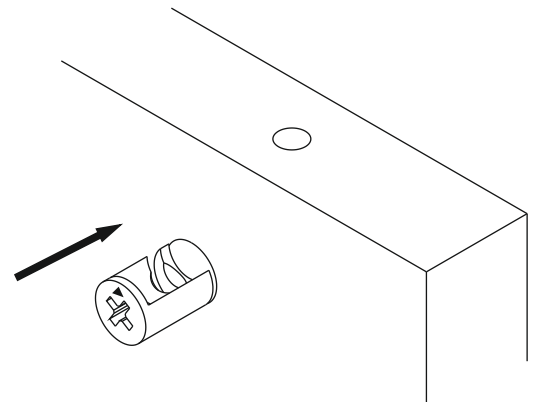
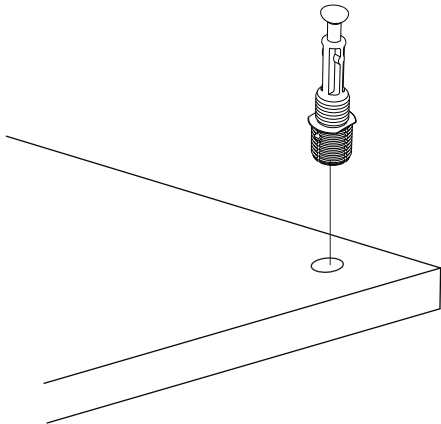
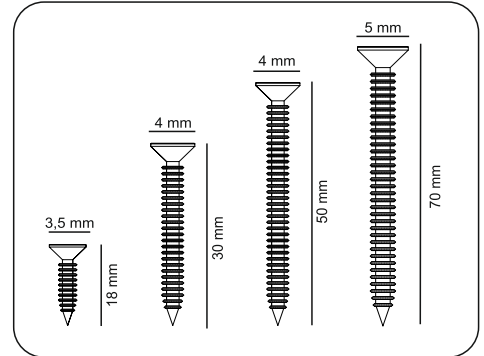
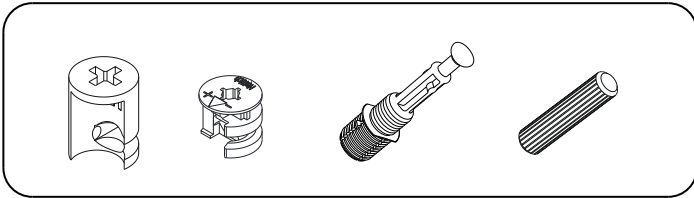





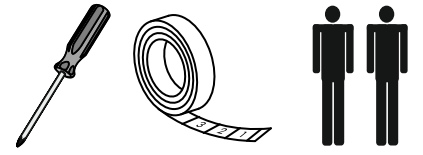



Bu modülün kurulumu için gerekli olan araçlar.
The necessary tools (not included)

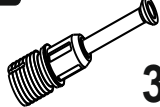
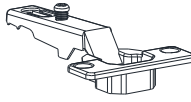
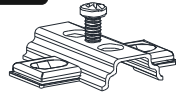
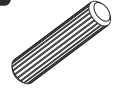

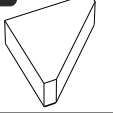
Bu modül iki kişi tarafından kurulmalıdır.
This unit should be assembled by two persons.

AKSESUAR LİSTESİ ACCESSORY LIST

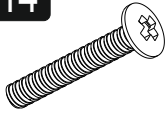
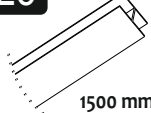
A01 Minifix Gövde  32x	A02 Minifix Mil  32x	A12 Düz Mentеше  4x	A13 Mentеше Altlığı  4x	A03 Kavela  44x
A10 3,5x18 YHB Vida  28x	A45 Üçgen ayak beyaz  4x	A50 Mantar Kulp  2x	A28 Arkalık Çivisi  30x	A04 Minifix Tapa Değişken 32x  0x
A14 M4x22 Kulp Vidası  2x	A25 "H" Arkalık Çıtası  1500 mm 5x			

GENERAL VIEW

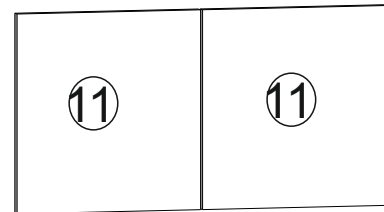
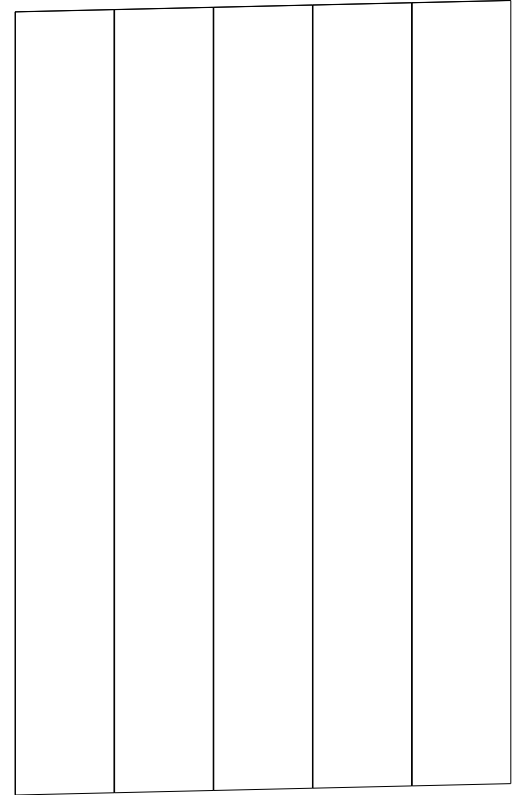
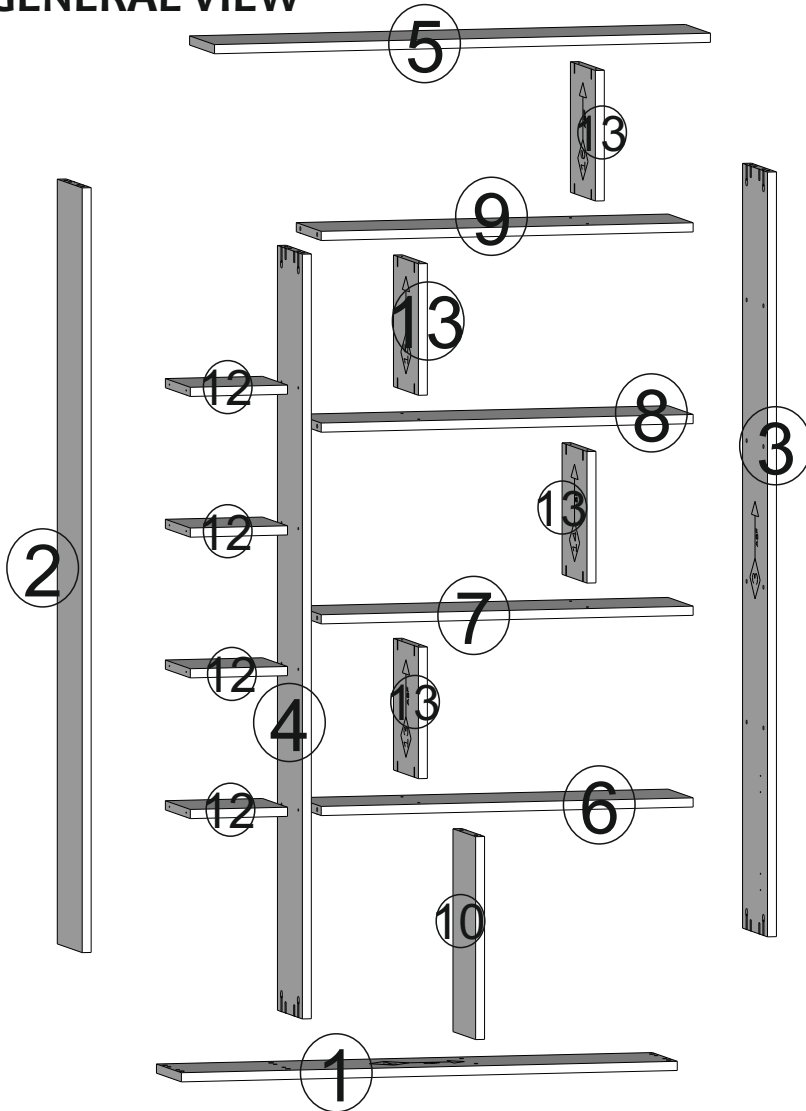

1

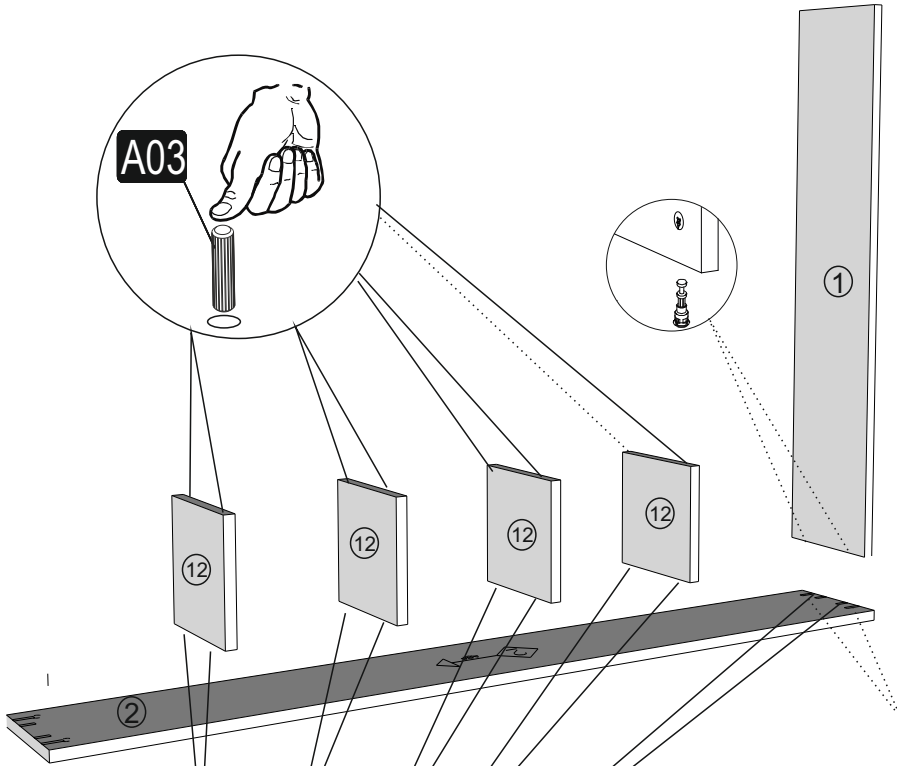

2

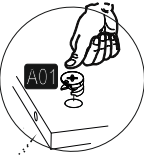
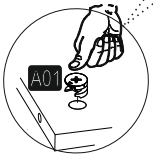
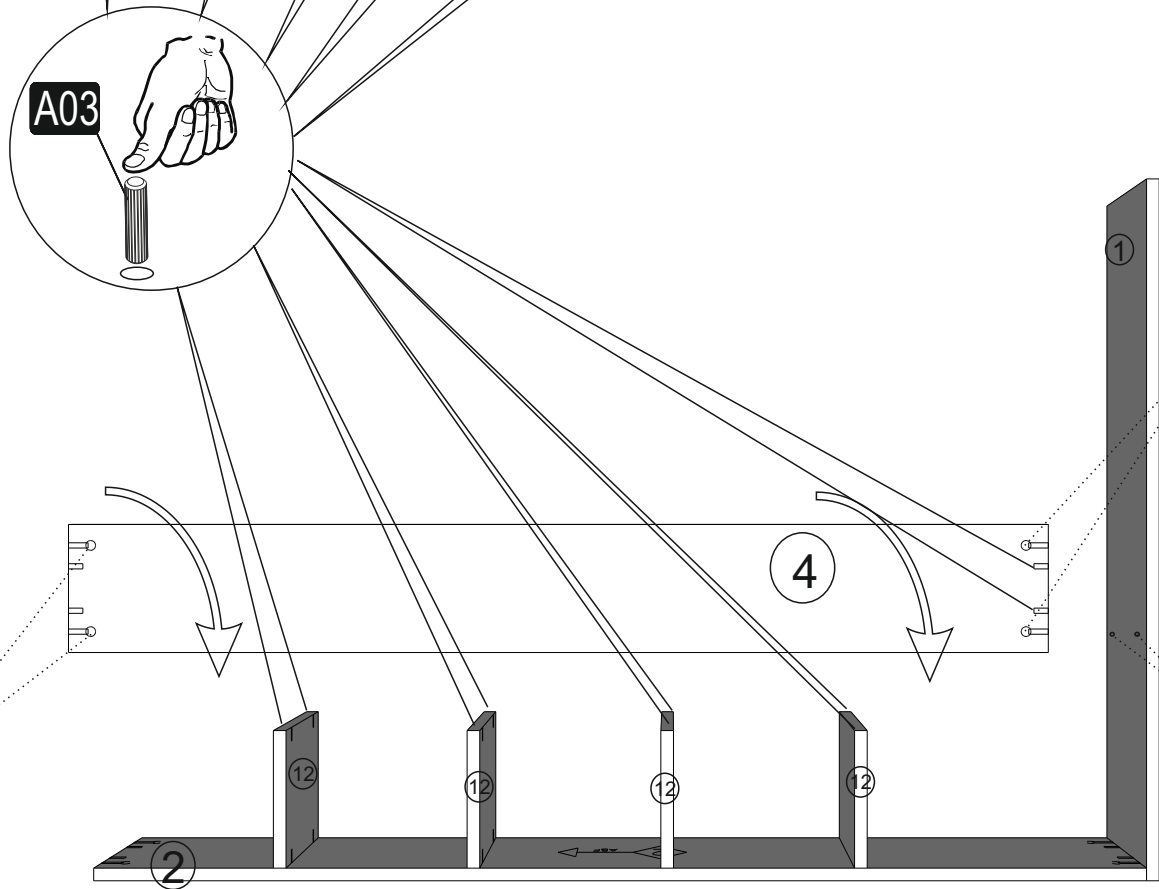

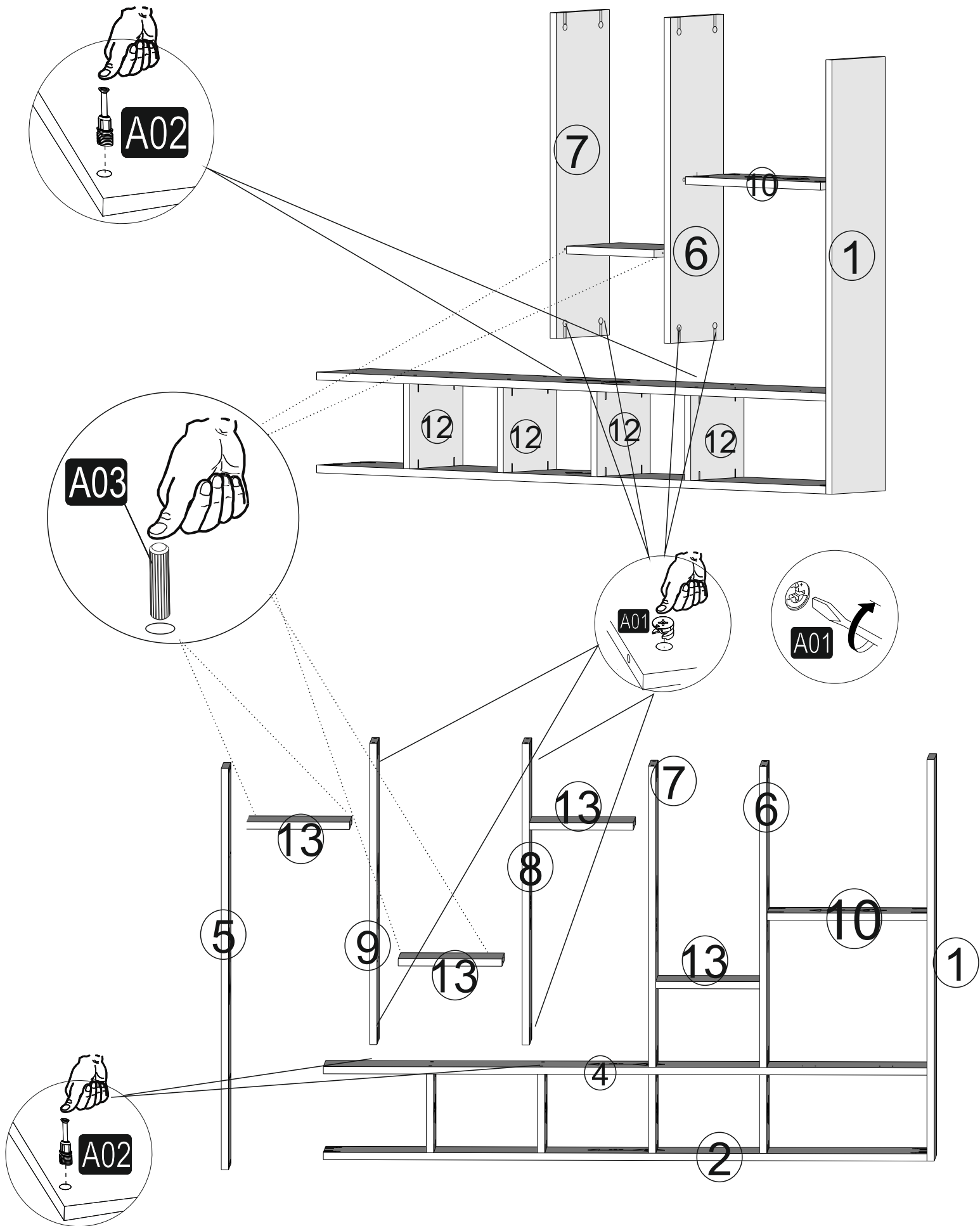

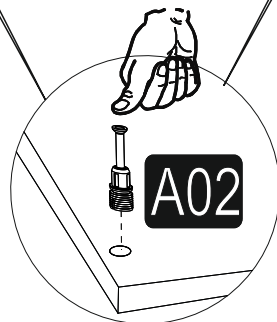
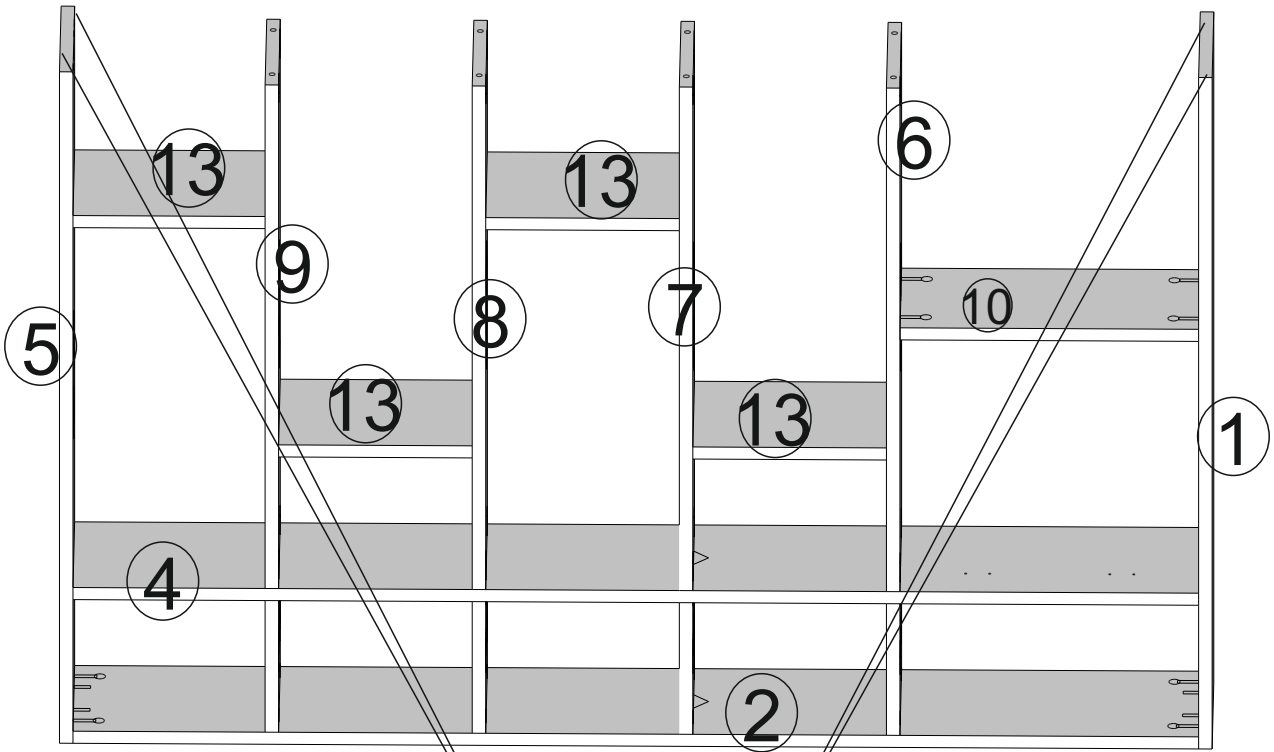
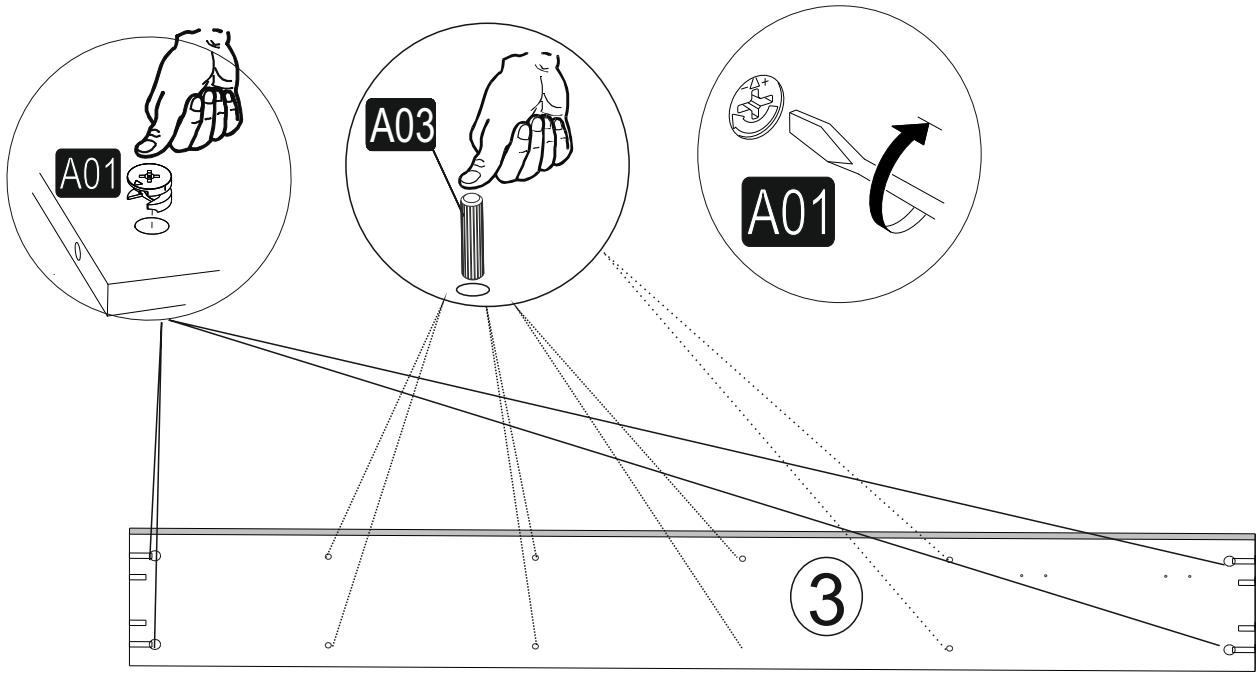

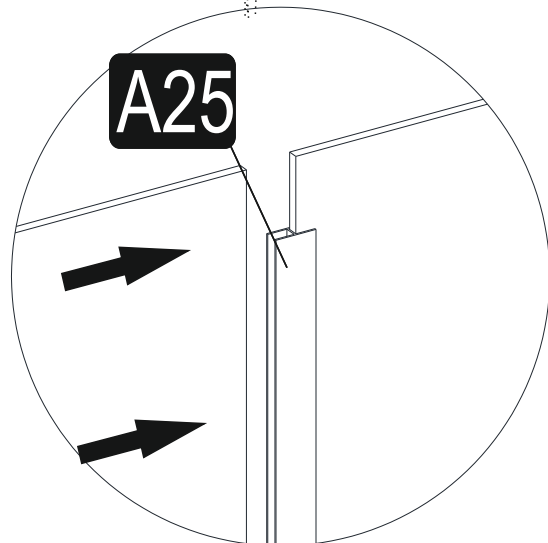
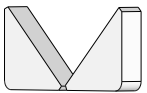
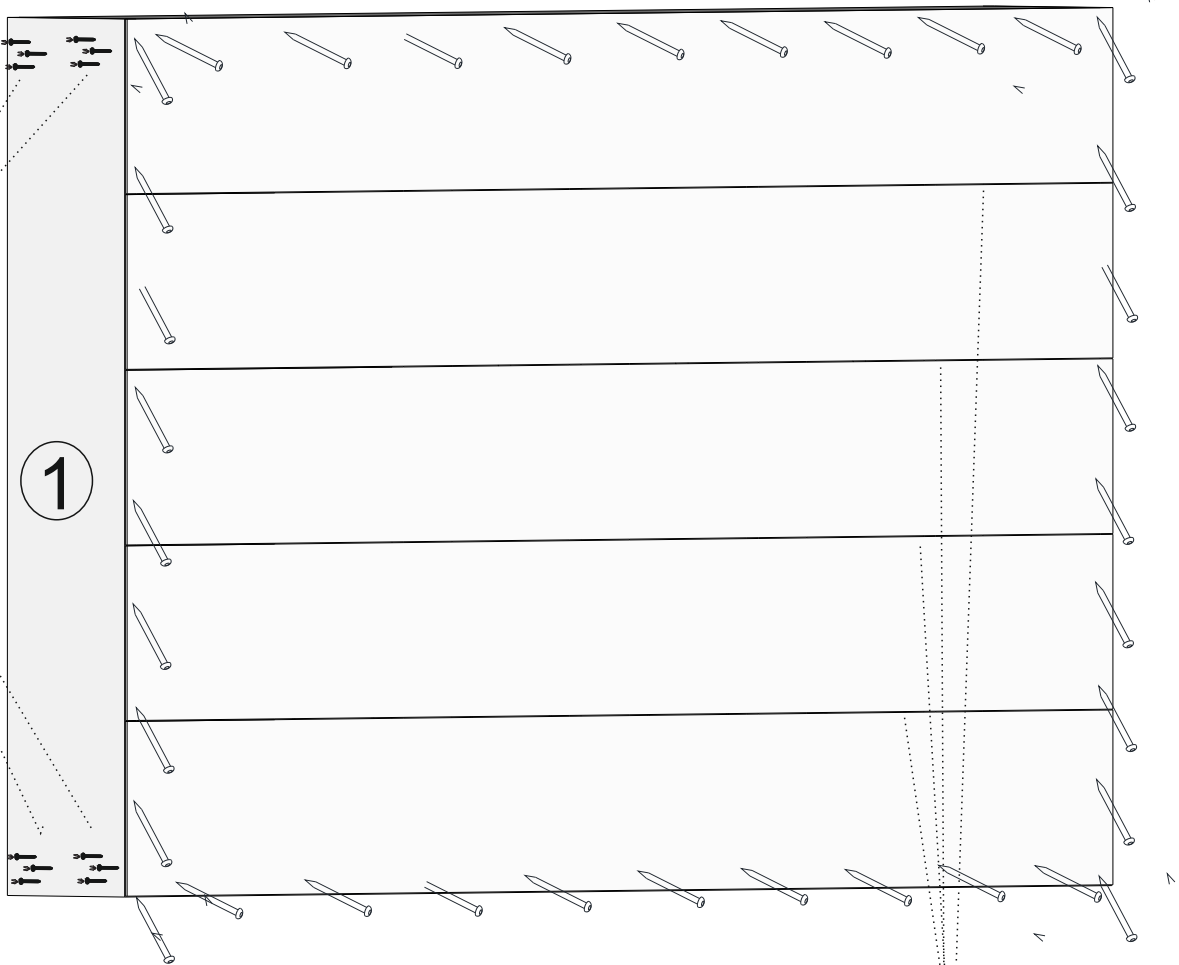
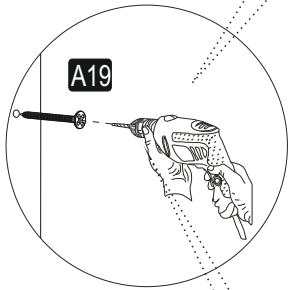
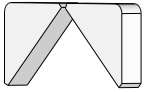
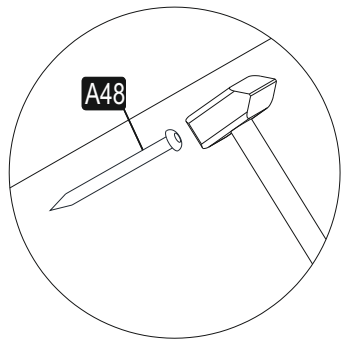

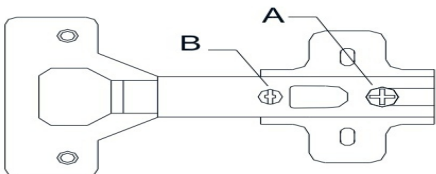
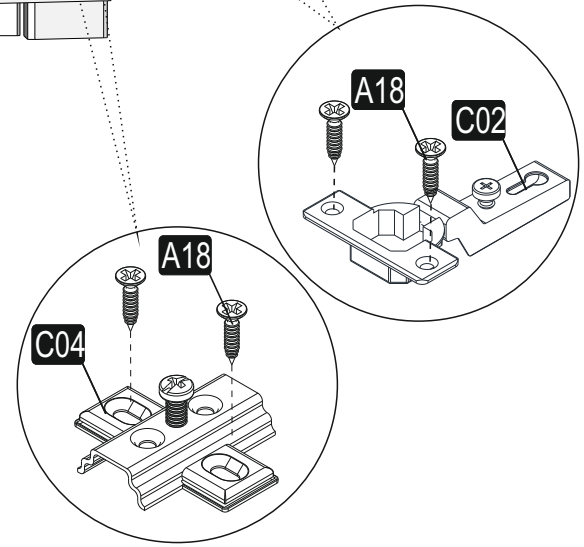
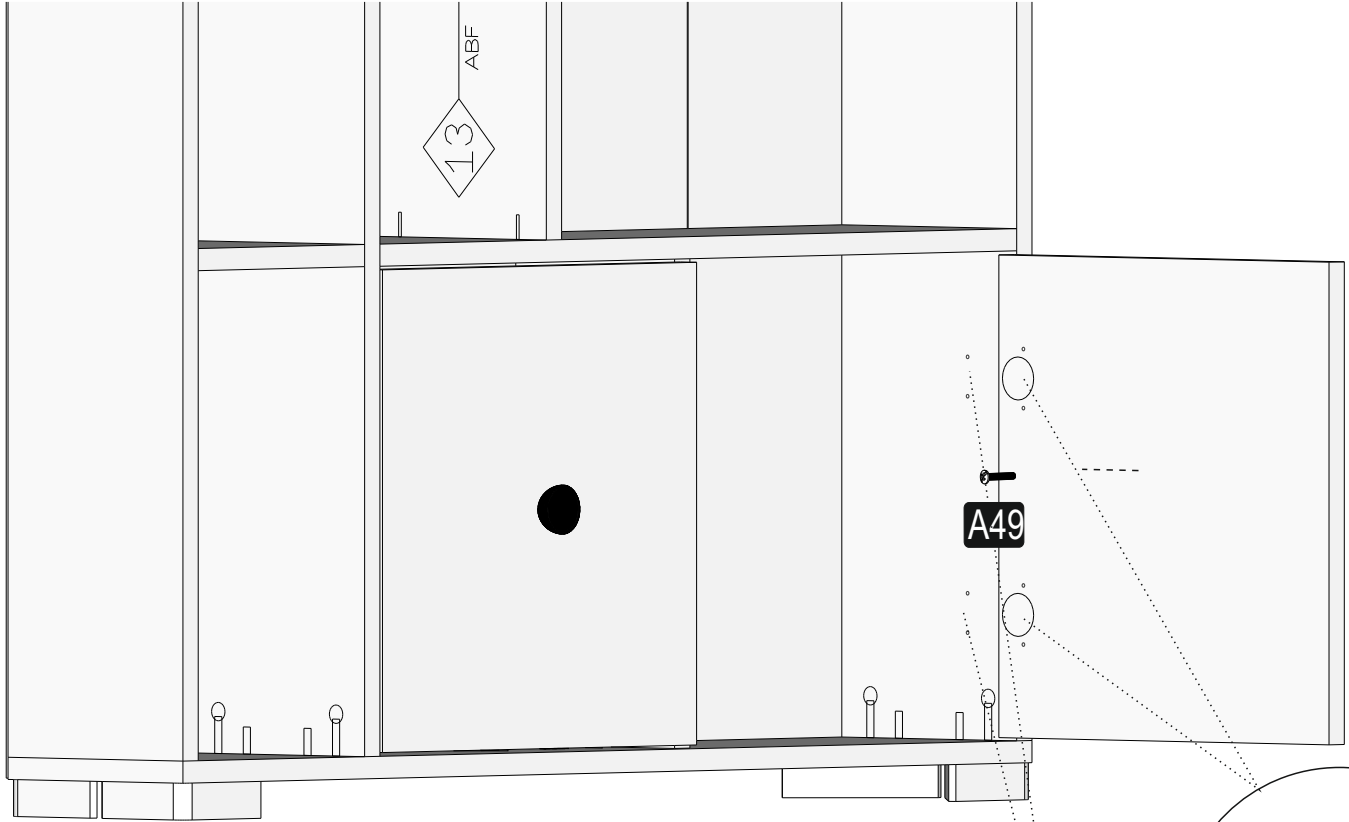

A= menteşe bağlama vidası / to connect the hinge to the door
 B= kapak ayar vidası / to arrange the door

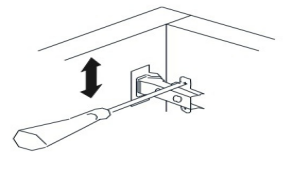
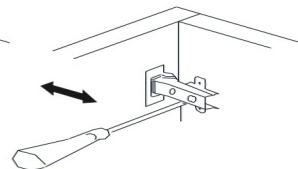
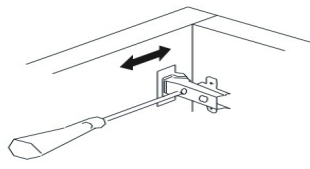

oklar kapağın ayarlama yönünü gösterir.
 arrows to show the directions for arrangement of doors.