

FLEXI MULTI PURPOSE CABINET

FLEXİ DOLAP

DLP3104

MONTAJ VE KULLANIM KILAVUZU ASSEMBLYMANUEL

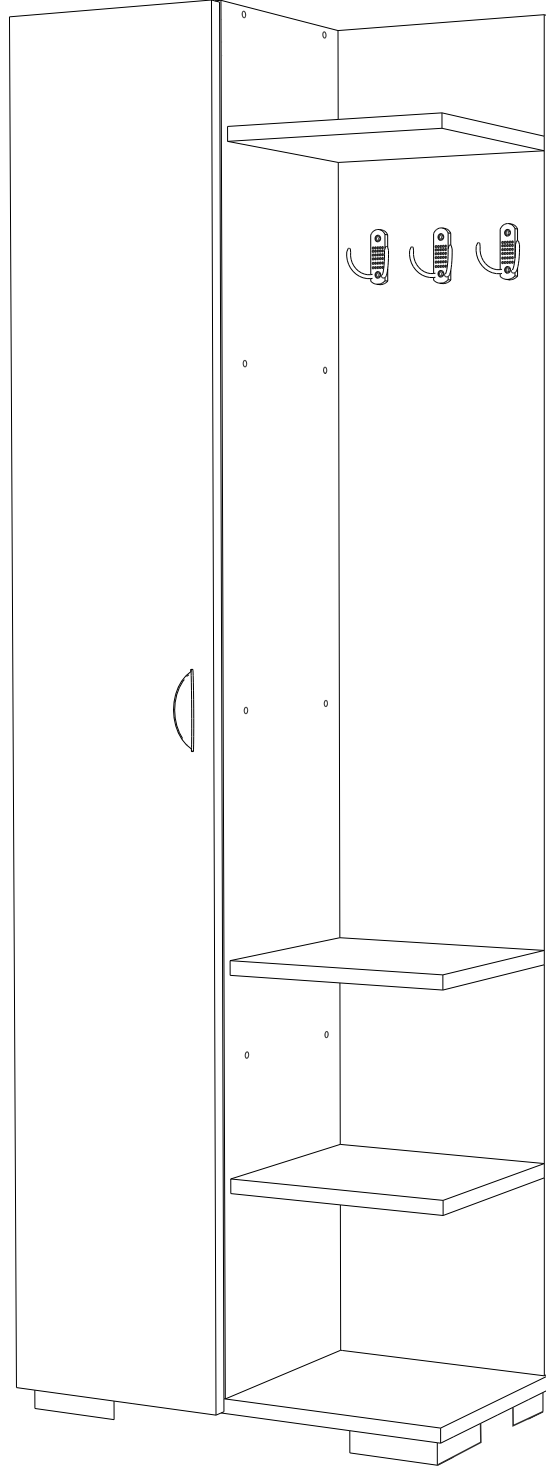



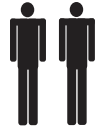





Bu modül iki kişi tarafından kurulmalıdır.
This unit should be assembled by two persons.



AKSESUAR LİSTESİ/ ACCESSORY LIST

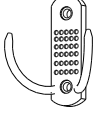
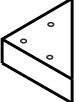

Bu modülün kurulumu için gerekli olan araçlar.
The necessary tools (not included)

A09 4x50 YHB Vida  38x	A16 Kabin VidasıTapa  38x	A10 3,5x18 YHB Vida  14 x	A28 Arkalık Çivisi  20x	A35 Askı Elemanı  3x
A21 ÜÇGEN AYAK  4x	A49 midye Kulp  1x	A14 M4x22 Kulp Vidası  2x	A12 Düz Menteşe  2x	3,5 x 30 YHB Vida ayak montaj  8x

PARÇA KODLAMA / GENERAL VIEW

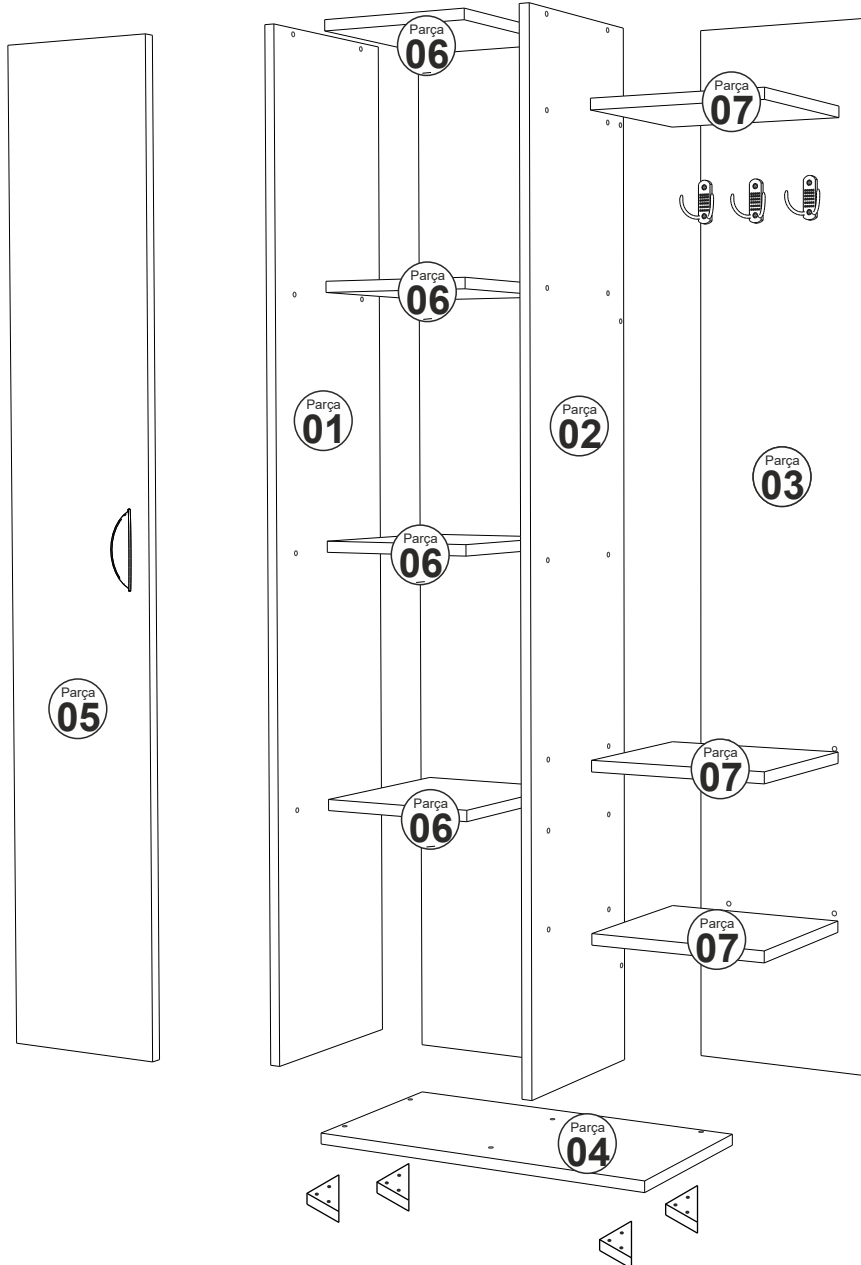

MONTAJKILAVUZU /ASSEMBLYMANUEL

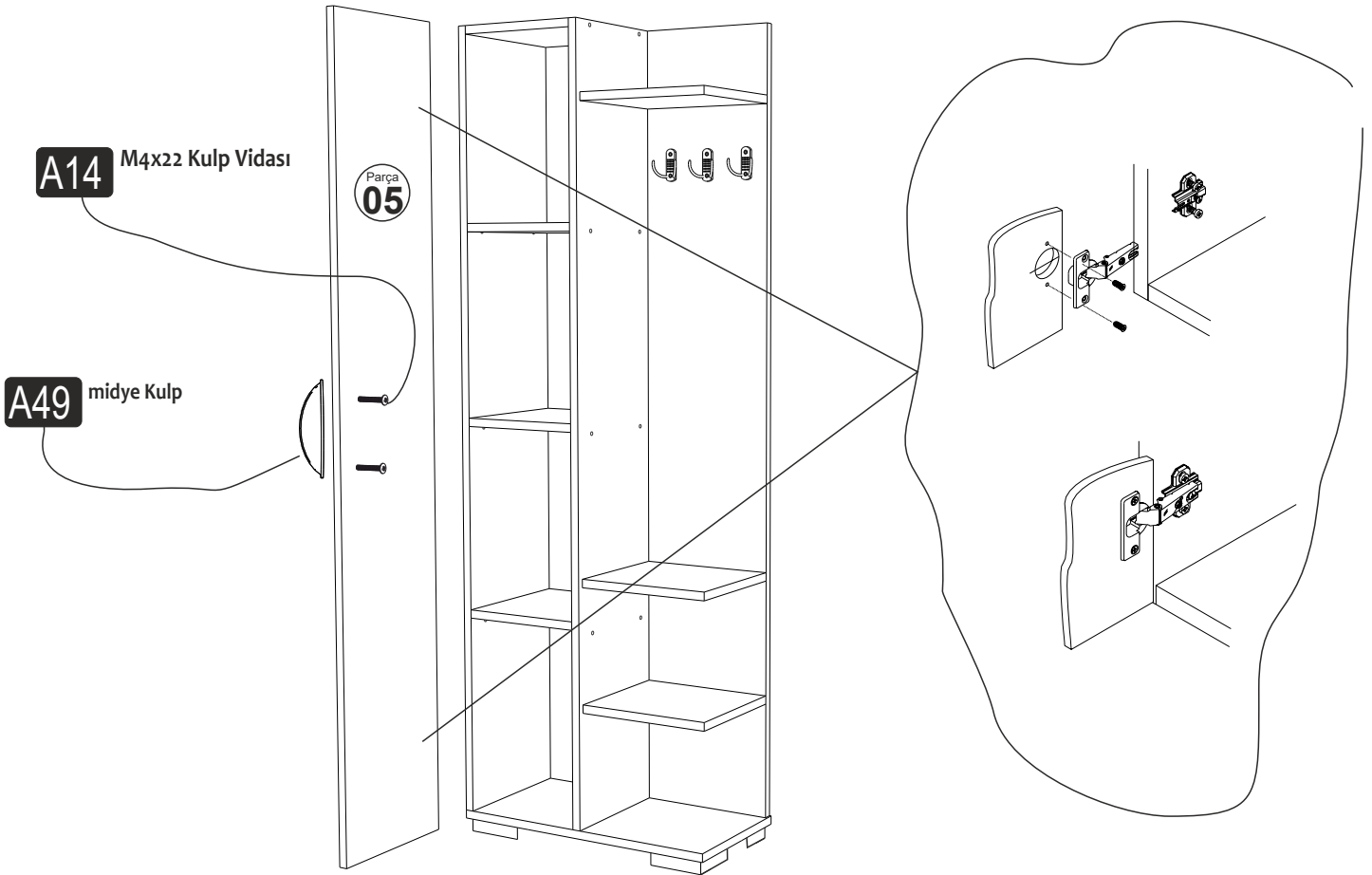
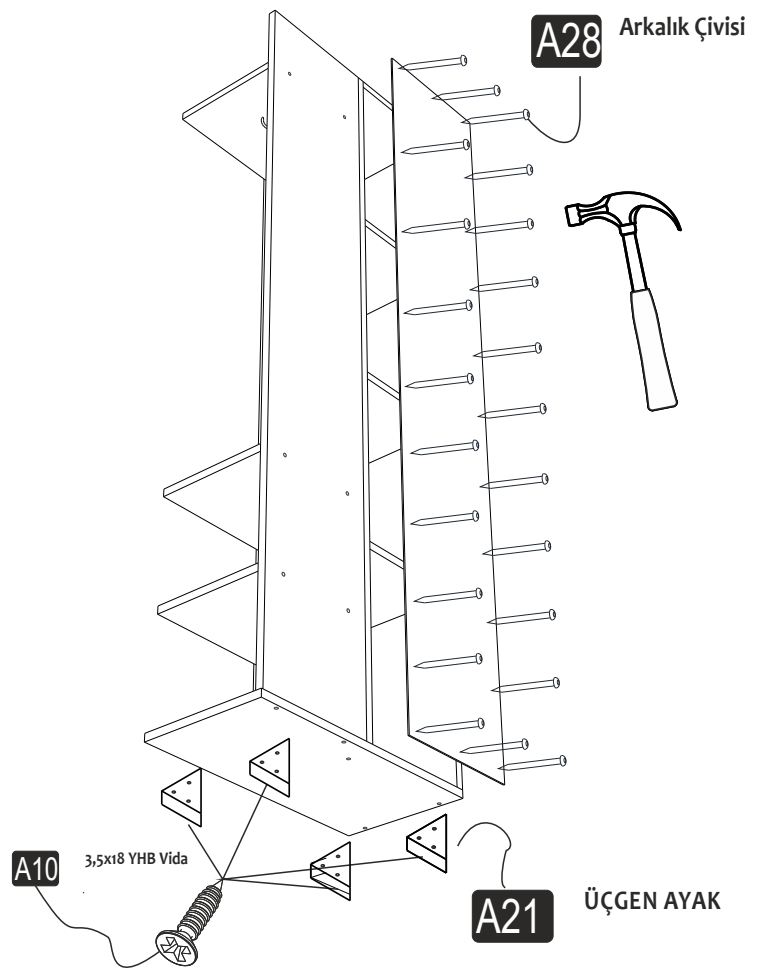
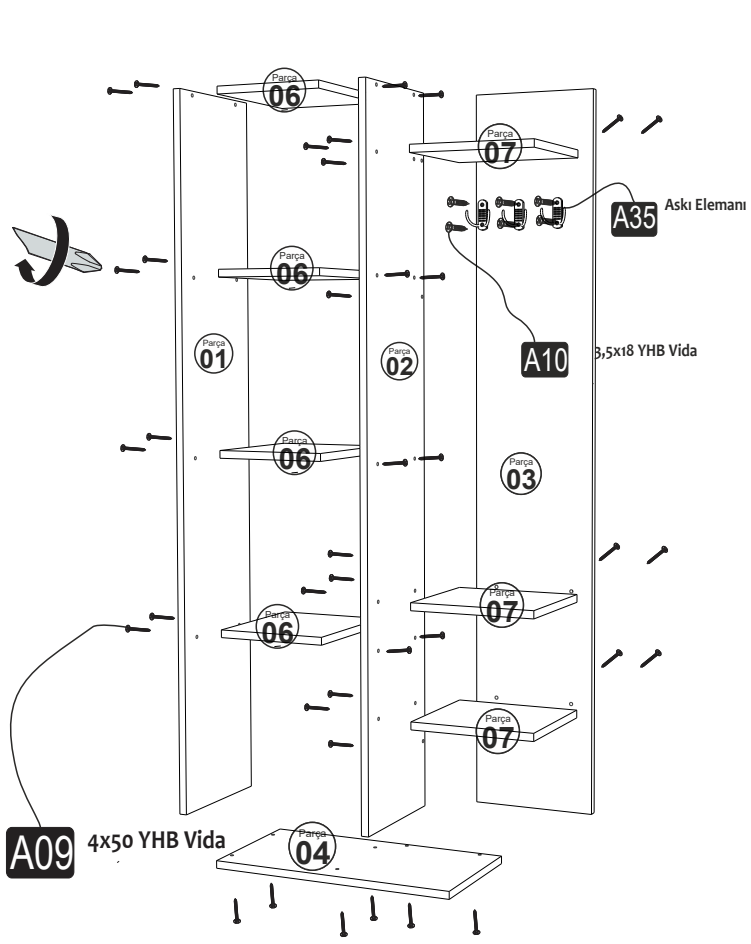

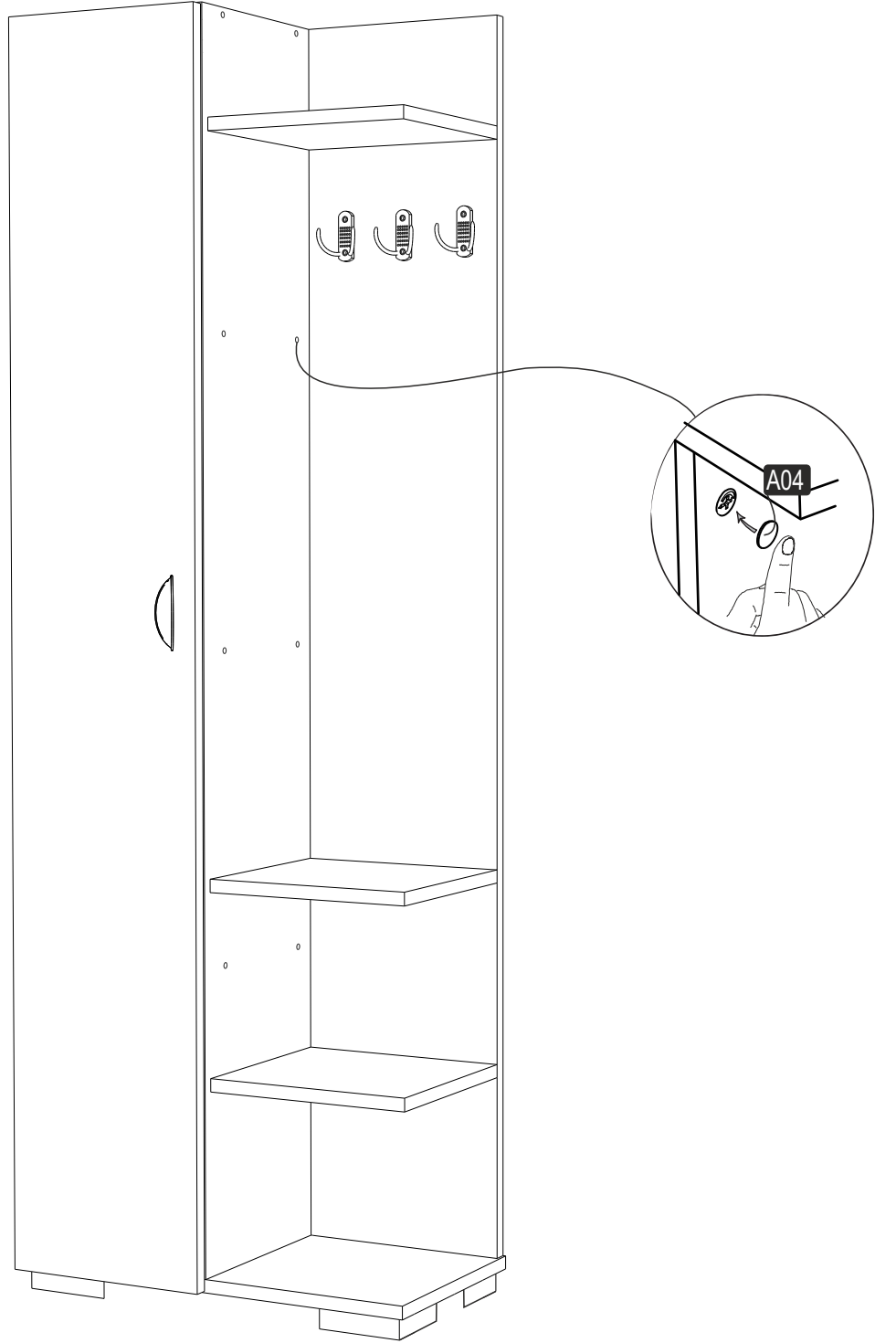

*D?đer ürünler?m?z? gördünüz mü?
Have you seen our other products ?*