

MILANO TV ÜNTESİ

MONTAJ VE KULLANIM KLAVUZU ASSEMBLY MANUEL

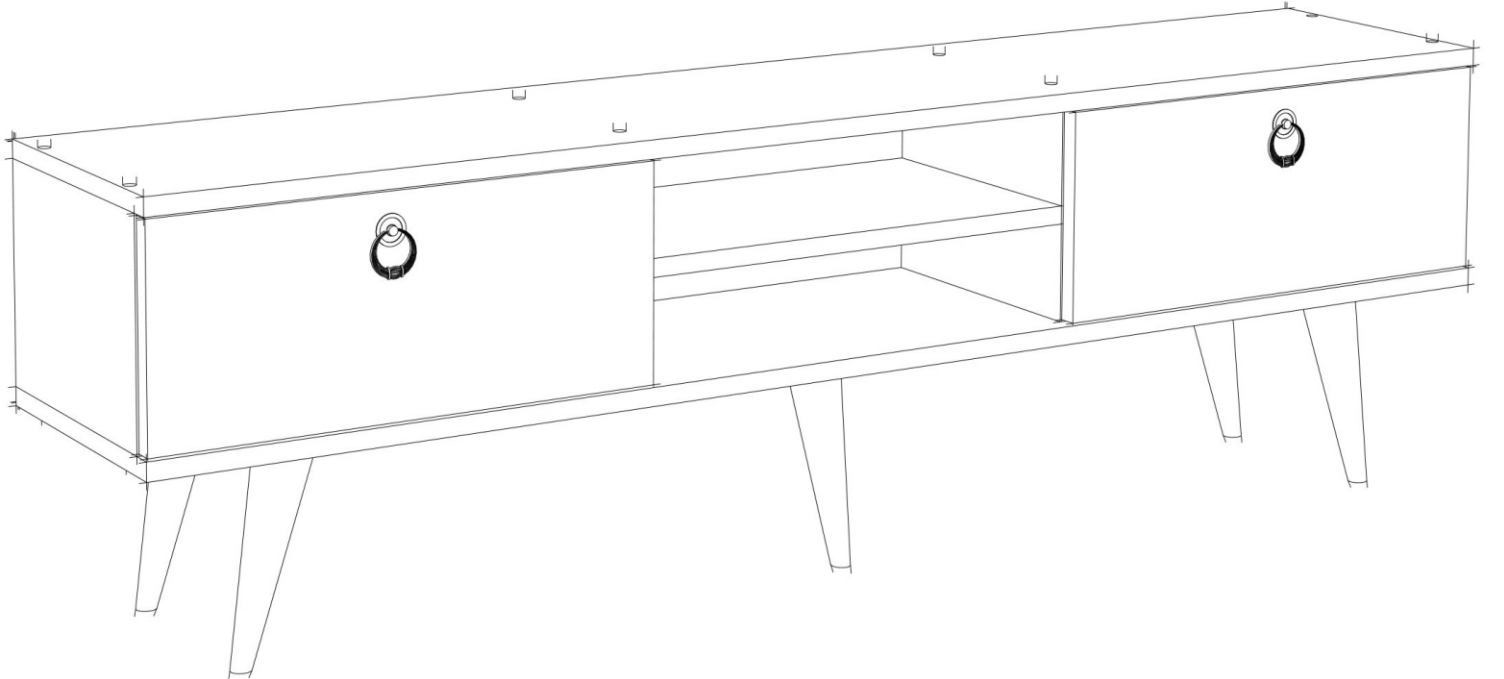

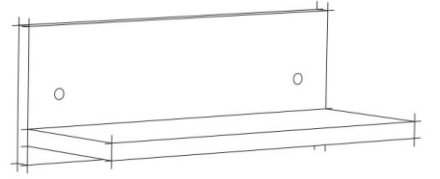

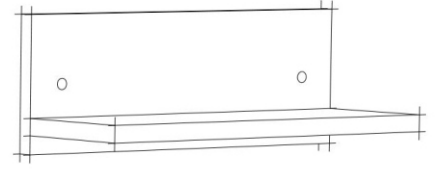



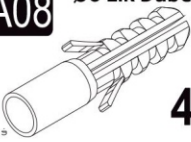
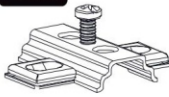

AKSESUAR LİSTESİ/ ACCESSORY LIST

Bu modül iki kişi tarafından kurulmalıdır.
This unit should be assembled by two persons.



Bu modülün kurulumu için gerekli olan araçlar.
The necessary tools (not included)

A10 3,5x18 YHB Vida  36x	A09 4x50 YHB Vida  28x	A08 Ø8 Lik Dubel  4x	A12 SDM  4x	A13 Menteşe Atlığı  4x
A28 Arkalık Çivisi  30x	A16 Kabin Vidası Tapa  28x	A18 yuvarlak asma kulp  2x	A38 Konik Plastik Ayak (Beyaz)  5x	A49 KLPVD  2x 20mm

PARÇA KODLAMA / GENERAL VIEW

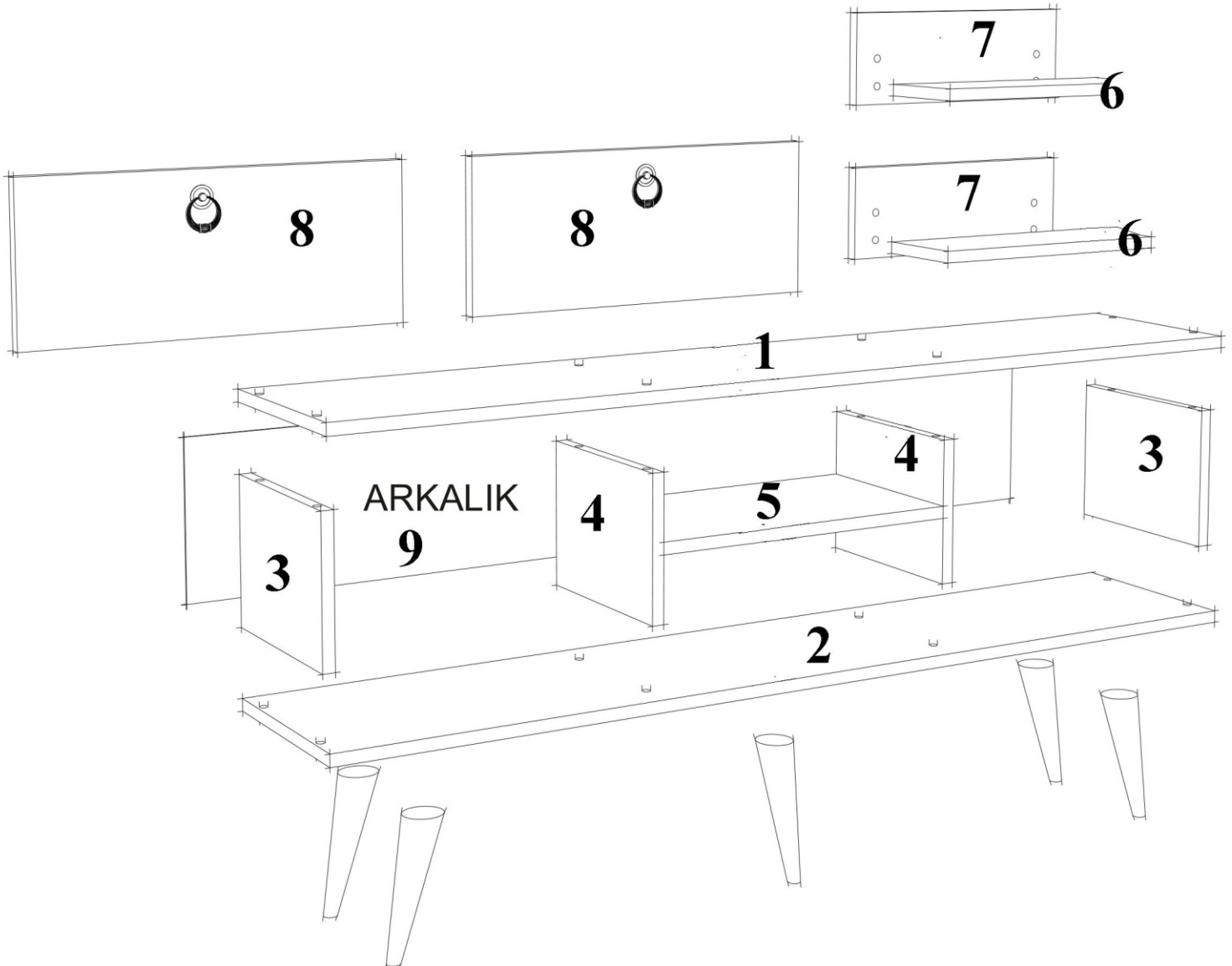

MONTAJ KILAVUZU / ASSEMBLY MANUEL

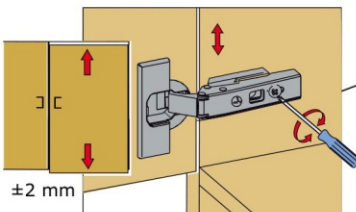
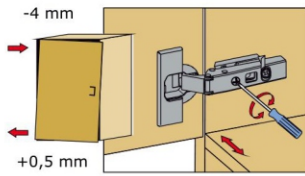
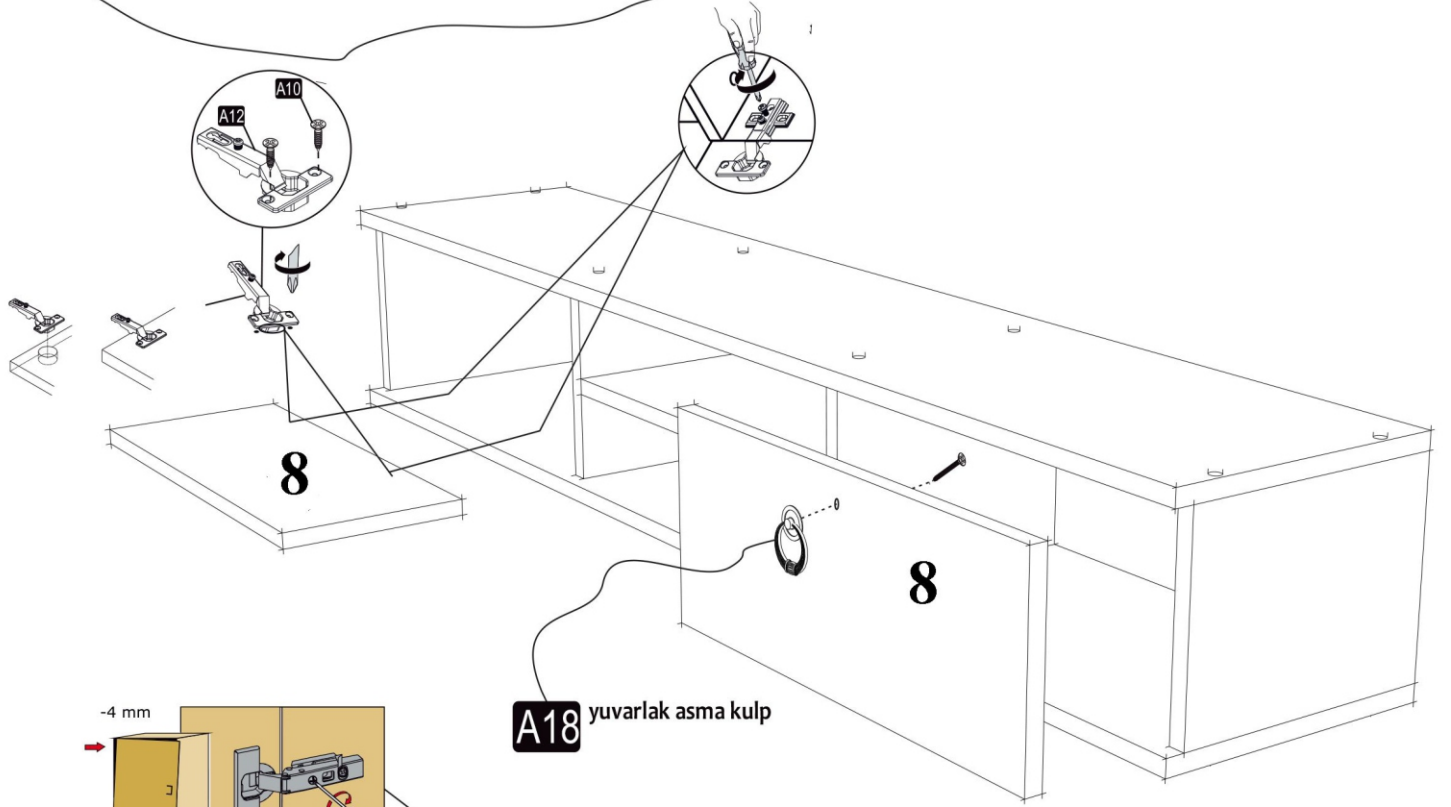
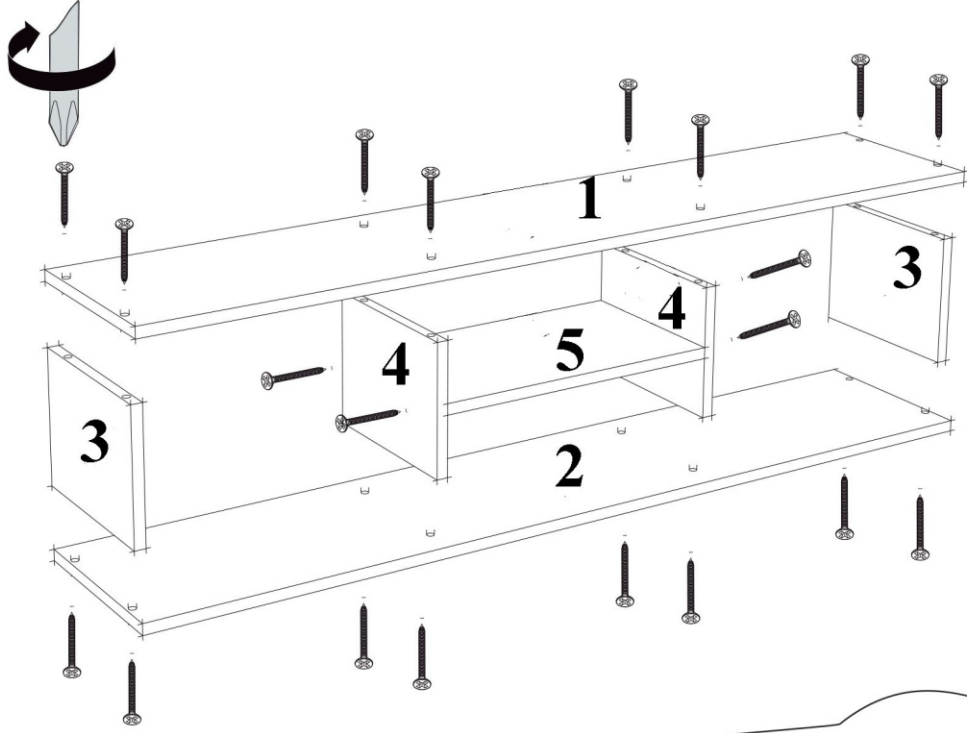

KAPAK AYARI ŞEMASI

