

UNI-T[®]

Instruments.uni-trend.com



User's Manual

UT5300X+ and UT5320R-SxA Series Programmable Hipot Tester

Preface

Thank you for purchasing UNI-T programmable withstand tester. In order to use this product safely and correctly, please read this manual thoroughly, especially the safety notes.

After reading this manual, it is recommended to keep the manual at an easily accessible place, preferably close to the device, for future reference.

Copyright Information

Copyright is owned by Uni-Trend Technology (China) Co., Ltd.

UNI-T products are protected by patent rights in China and other countries, including issued and pending patents. Uni-Trend reserves the rights to any product specification and pricing changes.

Uni-Trend Technology (China) Co., Ltd. all rights reserved. Licensed software products are owned by UNI-T and its subsidiaries or providers, which are protected by national copyright laws and international treaties.

Information in this manual supersedes all previously published versions.

UNI-T is the registered trademark of Uni-Trend Technology (China) Co., Ltd.

Warranty Service

The instrument has a warranty period of one year from the date of purchase. If the instrument is damaged due to improper operation by the user during the warranty period, the maintenance fee and the costs caused by the maintenance shall be borne by the user, and the instrument shall be maintained by the company for life.

If the original purchaser sells or transfers the product to a third party within one year from the date of purchase of the product, the warranty period of one year shall be from the date of the original purchase from UNI-T or an authorized UNI-T distributor. Power cords, accessories and fuses, etc. are not included in this warranty.

If the product is proved to be defective within the warranty period, UNI-T reserves the rights to either repair the defective product without charging of parts and labor, or exchange the defected product to a working equivalent product (determined by UNI-T). Replacement parts, modules and products may be brand new, or perform at the same specifications as brand new products. All original parts, modules, or products which were defective become the property of UNI-T.

The "customer" refers to the individual or entity that is declared in the guarantee. In order to obtain the warranty service, "customer" must inform the defects within the applicable warranty period to UNI-T, and perform appropriate arrangements for the warranty service.

The customer shall be responsible for packing and shipping the defective products to the individual or entity that is declared in the guarantee. In order to obtain the warranty service, customer must inform the defects within the applicable warranty period to UNI-T, and perform appropriate arrangements for the warranty service. The customer shall be responsible for packing and shipping the defective products to the designated maintenance center of UNI-T, pay the shipping cost, and provide a copy of the purchase receipt of the original purchaser. If the products is shipped domestically to the purchase receipt of the original purchaser. If the product is shipped to the location of the UNI-T service center, UNI-T shall pay the return shipping fee. If the product is sent to any other location, the customer shall be responsible for all shipping, duties, taxes, and any other expenses.

Limited Warranty and Liability

The warranty is inapplicable to any defects, failures or damages caused by accident, normal wear of components, use beyond specified scope or improper use of product, or improper or insufficient maintenance. UNI-T is not obliged to provide the services below as prescribed by the warranty:

- a) Repair damage caused by installation, repair or maintenance of personnel other than service representatives of UNI-T;
- b) Repair damage caused by improper use or connection to incompatible equipment;
- c) Repair any damages or failures caused by using power source not provided by UNI-T;
- d) Repair products that have been changed or integrated with other products (if such change or integration increases time or difficulty of repair).

The warranty is formulated by UNI-T for this product, replacing any other express or implied warranties. UNI-T and its distributors refuse to give any implied warranty for marketability or applicability for special purpose. For violation of the warranty, repair or replacement of defective products is the only and all remedial measure UNI-T provides for customers.

No matter whether UNI-T and its distributors are informed of any possible indirect, special, occasional or inevitable damage in advance, they assume no responsibility for such damage.

Safety Precautions

Warning  **Dangerous:** Please follow the following guidelines to avoid possible electric shock and risk to personal safety.

Users must follow the following conventional safety precautions in operation, service and maintenance of this device. UNI-T will not be liable for any personal safety and property loss caused by the user's failure to follow the following safety precautions.

Instrument grounding	To prevent the risk of electric shock, please connect the power ground wire.
Operating voltage	Please make sure operating voltage under rated range of 10%, to avoid damage the instrument.
Select connecting wire	Please use suitable electric wire to connect load and power to be measured. And ensure that the capacity of the electric wire can withstand the maximum shortcircuit current and not be overheat.
Input voltage	Before connecting the instrument, please read all the marks on the instrument. This instrument is support AC input of 110 V and 220 V. Please check the convert switch of programmable withstand tester whether is match with the input power before power on. And be sure the fuse is installed. Otherwise, it may damaged to the withstand tester.
Do Not operate in an explosive atmosphere	Do not use the instrument in flammable and explosive gas, steam or dusty environment. The use of any electronic equipment in such an environment is a risk to personal safety.

Do Not open the outer shell	Please do not open the outer shell of withstand tester. Only qualified maintenance personnel can open the outer shell. The instrument is still has unreleased electric charge for a period after power off, it may cause electric shock to person.
Do Not operate the instrument when it is abnormal	If the instrument can not work properly, the dangerous is unpredictable. Please cut off the power wire and do not use the instrument. Do not attempt to fix it by yourself.
Do Not operate the instrument out of the requirement of the manual	If operate the instrument out of the requirement specified in this manual, the protective for the instrument will be failure. It is strictly prohibited to use this equipment on life support system or any other equipment with safety requirements.
Do Not replace the component or execute unauthorized modification	In order to guarantee the safety of this instrument, please do not replace the component or execute any unauthorized modification. Do not operate the instrument if the outer shell is removed or loose.

Safety Sign

	Direct Current		Netrual/Zero Line
	Alternating Current		Live Line
	Both Direct and Alternating Current		ON (Power)
	Three Phase AC		OFF (Power)
	Grounding		Backup Power
	Protective Grounding		Connect with Cabinet or Case
	Signal Ground		Warning or Caution
	Dengerous		

Environment-friendly Use Period



EFUP is the period of time before any of the RoHS substances are likely to leak out, causing possible harm to health and the environment. EFUP of this instrument is 40 years, it should be recycling system when exceed 40 years.

Waste Electrical and Electronic Equipment (WEEE) Directive 2002/96/EC



Must not be discarded in the trash can.

1. Safety Regulation

This chapter includes the following contents.

- Workstation Arrangement
- Operator Regulation
- Prohibited Operation
- Daily Inspection for guarantee long-term use without failures

1.1 Workstation Arrangement

- Position of Workstation

Workstation should arrange in a capacious filed that is not necessary for general personnel, so that non-staff members are far away from the workstation. The workstation must separate from other facilities and it need to indicated particularly "High Voltage Test Worksation". During the testing, it must indicate "DANGER! Stay Away!"

- Input Power

Be sure to connect the instrument to ground for keep safe. The power supply of the workstation should have a separate siwth. The switch need to install in the prominent position on the entrance and marked with special sign to let people know this is the power switch of the workstation. Once an emergency accident happens, the switch can be shut down immediately and then deal with the accident.

- Workplace

An insulated worktable or workbench is must, any mental can not be used between operator and DUT. When design the workdfiled, it is not allowed that the operator across the DUT to operating the test instrument. The workplace should be tidy and clean. Unused instrument and test wire should put in a fixed position, make sure that all personnel can immediately distinguish the parts under test, to be tested and tested. The test station and its surrounding can not have flammable and corrosive gas and the tester can not be used near the flammable substance.

1.2 Operator Regulation

- Qualification of Personnel

The operating of this series tester is dangerous, misoperation will cause injury to personnel, and this injury is even life-threatening. So the user must be trained and strictly follow the user's manual.

- Safety Regulation

The operator must be given safety education and training at any time to understand the importance of various safety operations and follow the safety regulation to operating the tester.

- Dress Code

The operator shall not wear clothes with metal decoration, metal bracelet and watch, these metal ornaments may cause accidental electrical shock. The operator must wear the insulation gloves when operating the tester.

- Medical Regulation

It must not be allowed the personnel who has heart disease or wear heart rate regulator and cardiac pacemaker to operating the tester.

1.3 Prohibited Operation

■ Do not turn on/off the power repeatedly

After turning OFF the power switch, be sure to allow several seconds or more before turning it ON again. Do not repeat turning ON/OFF the power switch rapidly. If you do this, the protective measures of the tester may not be functioned properly. Do not turn OFF the power switch when the tester is delivering its test voltage—you may do this only in case of emergency.

■ Do not short the output to the earth ground

Pay attention so that the high test voltage line is not shorted to a nearby AC line or nearby devices (such as conveyors) which are connected to an earth ground. If it is shorted, the tester chassis can be charged up to the hazardous high voltage.

■ Do not apply an external voltage

Do not connect any external voltage to the output port of the instrument. The instrument has no external discharge function in non-discharge condition,

The analog voltmeter on the front panel cannot be used as stand-alone voltmeter. They may be damaged if their output terminals are subject to an external voltage. The output port connect to the external voltage may cause damage to the instrument.

1.4 To Ensure Long-Term Use without Failures

It is recommend to use the instrument in the range as follows.

Ambient Temperature	Maximum Output Power		Pause Time	Limited Output Time
T≤40°C	AC Withstand Voltage	>12mA (UT5320R+/S4A/S8A) >6mA (UT5310A/D/R+)	At least as long as the output time	Maximum of 120 seconds
	DC Withstand Voltage	>6mA (UT5320R+/S4A/S8A) >3mA (UT5310A/D/R+)	At least as long as the output time	Maximum of 120 seconds

Note: Output time = (voltage rise time + test time + voltage fall time)

1.5 Daily Inspection

To avoid accidents, confirm the several things at least the following before starting operation:

1. The input power source complies with the standard and the tester's power configuration is correct.
2. The tester is connected to earth ground.
3. The coating of the high-voltage test lead wire is free from cracks, fissures, and breakage.
4. Without connecting the test lines, the instrument can finish the test successfully when starting test by default.
5. The tester generates FAIL signal when the test wire is start to testing, low-voltage end of test lead contact with high-voltage end.

2. Product Overview

Thank you for purchasing UNI-T programmable hipot tester. This chapter includes the contents as follows.

- Product Series
- Front Panel
- Rear Panel

2.1 Product Overview

UT5300X+ series hipot tester includes model UT5310A+, UT5310D+, UT5310R+, UT5320R+, and UT5320R-SxA series hipot tester includes model UT5320R-S4A and UT5320R-S8A.

UT5300X+ and UT5320R-SxA series is a combination of electrical strength (AC/DC withstand voltage), insulation resistance of various test functions in one instrument. It can be widely used in household electrical appliances, transformer, electrical equipment and security performance checking of component.

Model	Function
UT5310A+	AC programmable hipot tester (10 mA), single channel
UT5310D+	AC/DC programmable hipot tester (10 mA), single channel
UT5310R+	AC/DC/IR programmable hipot tester (10 mA), single channel
UT5320R+	AC/DC/IR programmable hipot tester (20 mA), single channel
UT5320R-S4A	AC/DC/IR programmable hipot tester (20 mA), four channels
UT5320R-S8A	AC/DC/IR programmable hipot tester (20 mA), eight channels

UT5310A+ can provide withstand voltage test 5 kVAC/10 mA.

UT5310D+ can provide withstand voltage test 5 kVAC/10 mA and 6 kVDC/5mA.

UT5310R+ can provide withstand voltage test 5 kVAC/10 mA, 6 kVDC/5mA and insulation resistance test 2.5 kVDC/10 GΩ.

UT5320R+ can provide withstand voltage test 5 kVAC/20 mA, 6 kVDC/10 mA and insulation resistance test 2.5 kVDC/10 GΩ.

UT5320R-S4A/S8A adds scan module of 4 channels /8 channels double end and with touch inspection function based on UT5320R+.

■ Rapid Test

This series tester has high performance 32 bits ARM microprocessor, it can measure various safety regulation parameters of DUT in real-time and especially for the rapid test of the product line.

■ Easy Operation

This series tester has 4.3 inch true color LCD, it can use variety of physical keys and digital keyboard to quickly set test conditions and complete the test. It's very easy to operate.

■ Intelligent Judgement

This series has intelligent judgement of upper and lower limit, it can automatic judge the defects and with audible and visual alarm.

■ **Reliable Operation**

This series tester use full isolation measures between the entire circuit modules, it has strong anti-interference ability. High voltage module is DA standard, controllable sine wave generator, class AB power amplifier, 40~600 Hz step-up high tension transformer, and close-loop control of output voltage with hardware and software protection, which greatly improving the reliability of the instrument.

■ **Safety Use**

Ground wire current detection, short-circuit detection, electric arc detection, DC quick discharge, automatic over-voltage, over-current protection. All of these function are designed for safety use.

■ **File Management**

It can programme 100 test files and each file can have 20 test items.

■ **Various Interface**

This series equipped with Handler (PLC) interface for industrial control, RS485 (option), RS-232C and LAN interface for PC connection, and supports SCPI and Modbus RTU communication protocols to efficiently complete remote control and data acquisition functions, so the instrument can suitable for the needs of multiple different automatic test system.

2.2 Front Panel

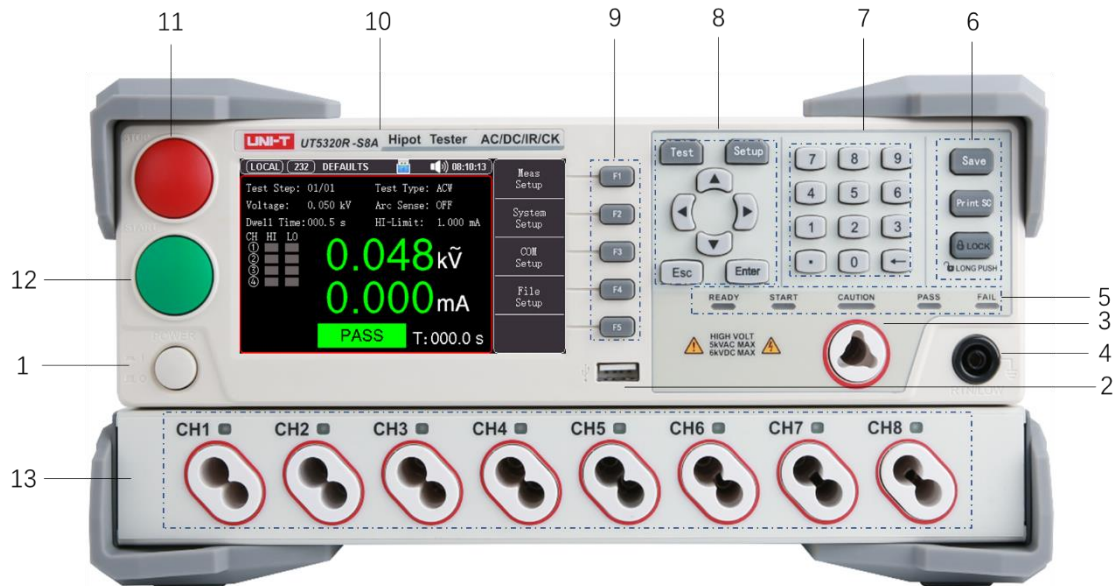

Figure 1-2-1 Front Panel (Take UT5320R-S8A as an example)
(It is suitable for UT5310A+/D+/R+/UT5320R+/UT5320R-S4A)

Table 1-2-1 Front Panel

No.	Name	Description
1	Power switch	Turn on/off the power of programmable hipot tester.
2	USB interface	It is to connecting USB disk flash. It supports file system of FAT16 and FAT32 and also support firmware upgrade, record test data, save screen image and storage and reload test parameter file.
3	Output voltage high-end	Test the high-end of output voltage
4	Output voltage low-end	Test the hlow-end of output voltage
5	Indicator light	Ready/Start/Caution/Pass/Fail indicator light
6	Function key	Save key

		Print SC key LOCK key
7	Digital key	Full function digital/character keyboard is to input data or enter characters when requested for note information such as file name.
8	Main menu key Arrow key	Test key is to display the measured result and for selection. Setup key is to set test condition and for selection. ◀▶▶▶ Arrow key Ese key Enter key
9	Function soft key	It divide into five keys, it has different function on different menu. The corresponding function will display on the right side of menu area.
10	Trademark and model	Model label
11	STOP key	STOP key is to stop the test or cancel the hint of PASS, FAIL.
12	START key	START key is to start the test, once the test is running, CAUTION, START indicator light will be sparkling.
13	Multiple channel's scan interface	Only for UT5320R-S4A (4 channels) and UT5320R-S8A (8 channels).

Warning: Do not touch the test port during the test.

Note: If apply an external voltage to the test port, it may cause damage to the instrument's internal circuit.

2.3 Rear Panel

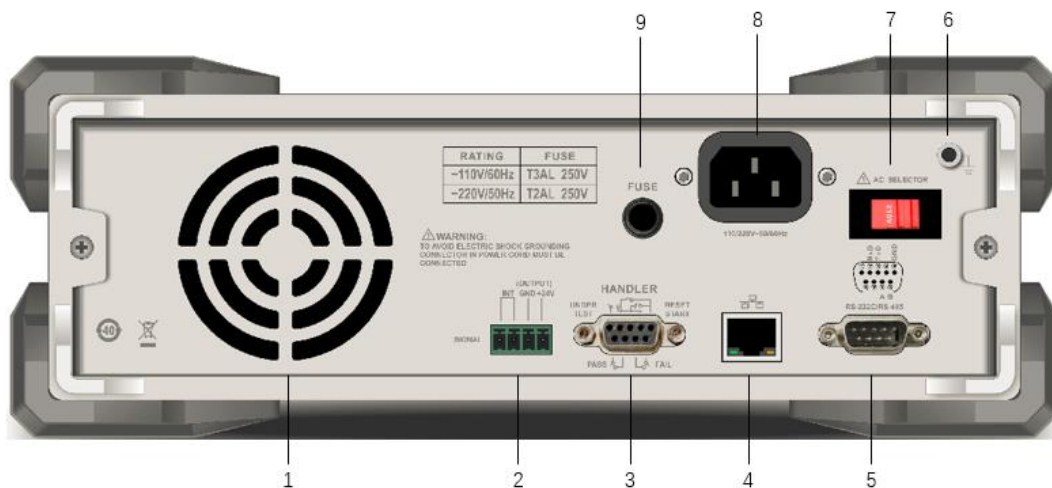

Figure 1-3-1 Rear Panel

Table 1-3-1 Introduction of Rear Pane

No.	Name	Description
1	Cooling fans	The cooling fans needs continuous work, so please maintain a good exhaust and heat dissipation space behind the back panel.
2	SIGNAL interface	This interface is the output interface of online protection and internal 24 V power.

		<System Setup> page, if [Safety Lock] function is enabled, then the external should provide online lock signal. Otherwise, this instrument is not allowed to start the test.
3	HANDLER interface	Remote signal input/output terminal. It can input the control signal of RESET and START. Use RELAY junction to output the signal of PASS, FAIL and TEST.
4	LAN interface	Connect when using a LAN interface. (Only for UT5310R+/20R+/S4A/S8A)
5	RS-232C interface /RS-485 interface (option)	Serial communication interface is to communicate with the PC.
6	Protective ground terminal	Chassis ground terminal. Before operating the instrument, please make sure that the ground is properly connected.
7	AC 220/110 adaptor	Voltage scale switch of AC, the instrument is only support two voltage modes of 110V and 220V.
8	Input power socket	Standard IEC 320 power socket for connection to NEMA standard power cord.
9	Fuse socket	If nneed to change the fuse, please replace the standard fuse.

3. Inspection and Installment

This chapter includes the contents as follows.

- Packing List
- Power Requirements
- Operation Environment
- Key Points When Moving the Instrument
- Cleaning
- Power on

3.1 Packing List

Before use the instrument please checke







1. Inspect the product's appearance whether has damage, scratch or flaws;
And confirm the instrument's model, this series divided into several withstand voltage tester as shown the following table.

Model	Function
UT5310A+	AC programmable hipot tester (10 mA), single channel
UT5310D+	AC/DC programmable hipot tester (10 mA), single channel
UT5310R+	AC/DC/IR programmable hipot tester (10 mA), single channel
UT5320R+	AC/DC/IR programmable hipot tester (20 mA), single channel
UT5320R-S4A	AC/DC/IR programmable hipot tester (20 mA), four channels
UT5320R-S8A	AC/DC/IR programmable hipot tester (20 mA), eight channels

2. Inspect appendix for the list of accessories.
If any of the accessories are missing or damaged, please contact UNI-T or local distributors of this product.

Item	Quantity	Remarks
Programmable hipot tester	1pcs	The model is subject to the actual order
Power cable	1pcs	
RS232C communication wire	1pcs	
High voltage test probe	1pcs	
High voltage test clip (red and black)	1 pair	
Double head high voltage test wire (with clips)	1 pair	Only for UT5320R-S4A/S8A
Double head high voltage test wire	Match with the channel	Only for UT5320R-S4A (4 wires)/S8A (8 wires)
Factory calibration report	1pcs	
User's Manual	1pcs	Electronic file, it can be download form UNI-T official website
Fuse	2pcs	

3. Introduction of test wire

Model	Name	Standard/Option	Picture
/	A pair of high voltage test clips	Standard	
/	High voltage test probe	Standard	
/	Double head high voltage test wire (no clips)	Standard (multiple channels)	
/	Double head high voltage test wire (with clips)	Standard (multiple channels)	
/	Single head high voltage test wire (no clips)	Option	
UT-L62	Remote high voltage test wire (support remote boot)	Option	

3.2 Power Requirements

This instrument is designed for use under class II voltage. Do not use under overvoltage class III and IV.

Before start the power, please make sure that power voltage is conform to AC SELECTOR on the rear panel of the instrument.

Input Voltage	Frequency Range	Fuse	Model	Rated Power
110 V	47-63 Hz	5 A	UT5320R+/S4A/S8A	400 VA
110 V		3 A	UT5310A/D/R+	300 VA
220 V		3.15 A	UT5320R+/S4A/S8A	400 VA
220 V		2 A	UT5310A/D/R+	300 VA



Warning:

- In order to prevent the electric shock, please connect the power ground in properly. If user replace the power cable, please make sure that the power ground is reliable connected.
- In order to prevent the electric shock, turn off the power and plug the power cable before checking or replacing the fuse.

3.3 Operating Environment

UT5300X+ and UT5320R-SxA Series operating environment

Temperature: 10°C ~ 40°C

Humidity: 10%-80%RH

3.4 Key Points When Moving the Instrument

When moving or transporting the instrument, please follow the protective measures.

Before moving the instrument, turn off the power switch.

If move the instrument under power on status, it may cause electric shock and damage.

Before moving the instrument, cut off all the connected cables.

If move the instrument with all the connected cabled, it may damaged to the connected wire or overturn the instrument.

3.5 Cleaning

In order to prevent the electric shock, please plug the power cable before cleaning.

Please use a damp but not dripping soft cloth to wipe the chassis and panel, keep it dry and no water shall into the instrument.

Do not clean the internal of the instrument.

3.6 Power on

3.6.1 Initial Power on

After confirm the instrument is intact and installed in properly, please inspect it as the following steps.

- 1) Only connect the power cable of the instrument and not connect other test wires, and then turn on the tester's power switch;
- 2) After the instrument enters the measurement interface, press **START** key directly to test, the test status should be
 - a) Insulation resistance display $>10\text{ G}\Omega$;
 - b) Withstand voltage display is small striking current or zero.

Then it indicates the instrument is basically normal.

If there is no display when boot the instrument for the first time, please checke whether the power cable is connected;

If there is no power on, no key respond or no relay action sound, please contact UNI-T for technical support

3.6.2 Prepare Test Wire

- 1) Connect the red high voltage test clip (or high voltage test probe) to L, N of DUT;
- 2) Connect the test return conductor to the ground or chassis of DUT.

4. Measurement Display

This chapter includes the contents as follows.

- On-screen Display
- Status Bar
- Test Result
- Screenshot
- Keyboard Lock

4.1 On-screen Display

When high voltage stops to output, press [Test] key to enter <Measurement> page. High voltage only can be activated in measurement page.

<Meas Setup> page is to display the measured result and judgement result;

LCD will divide into several areas to display the corresponding information when enters the test mode.

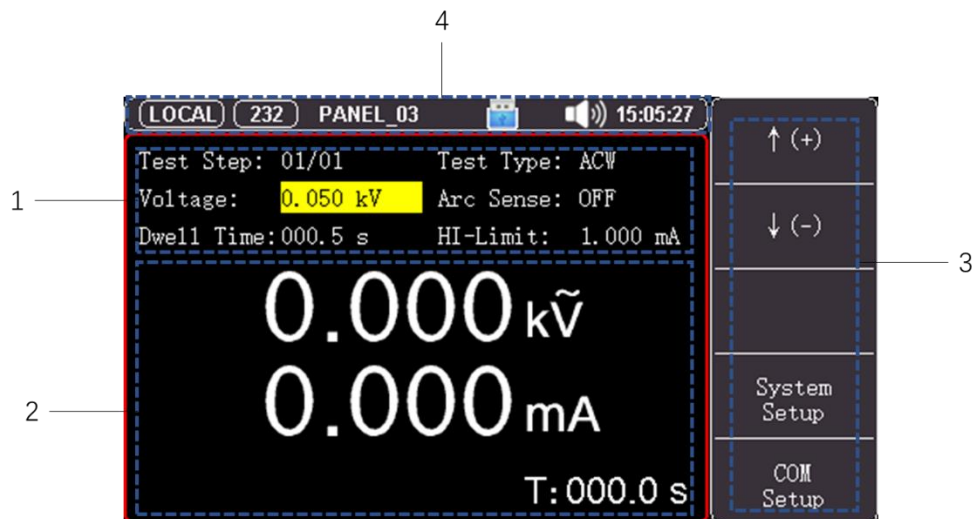

Figure 4-1 Test Interface of Single Channel

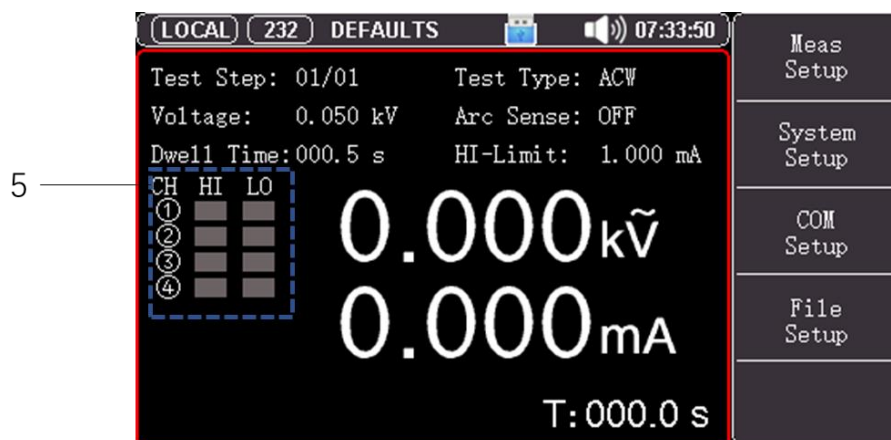

Figure 4-2 Test Interface of Multiple Channels (Take S4A as an example)

4.1.1 Test Interface

No.	Name	Function Description
1	Test parameter	Display test parameter and status.
2	Time display	Display real-time voltage, current and test time.
3	Mode selection (soft keyboard)	For select the operating mode of programmable hipot tester. Activate the key function in other interface at the bottom of the screen.
4	Status bar	Display data, user's name and icon.
5	Channel setting (only S4A/S8A)	Connect to high-end, low-end or cut-off.

4.2 Status Bar



Figure4-3 Icon of Status Bar

Table 4-1 Description of Status Bar

No.	Icon	Description
①		START boot-up key on the front panel, it's only activated when start mode is local in system setup.
		PLC boot-up key, it's only activated when start mode is PLC in system setup.
②		It indicates RS-232 interface is activated.
		It indicates RS-485 interface is activated.
		It indicates LAN interface is activated.
③		It indicates the file name of the current test file.
④		It indicates the key is locked.
⑤		It indicates U flash disk is ready to use.
⑥		It indicates the internet is connected.
⑦		It indicates sorting sound and key sound.
		It indicates sorting sound and key sound are both forbidden.
		It indicates only key sound is enabled.
		It indicates only sorting sound is enabled.
⑧		It indicates time display.

4.3 Test Result

Only in the measurement display interface can start high voltage to measure DUT, its test parameters must be set in the measurement interface.

Figure 4-4 Test is Qualified

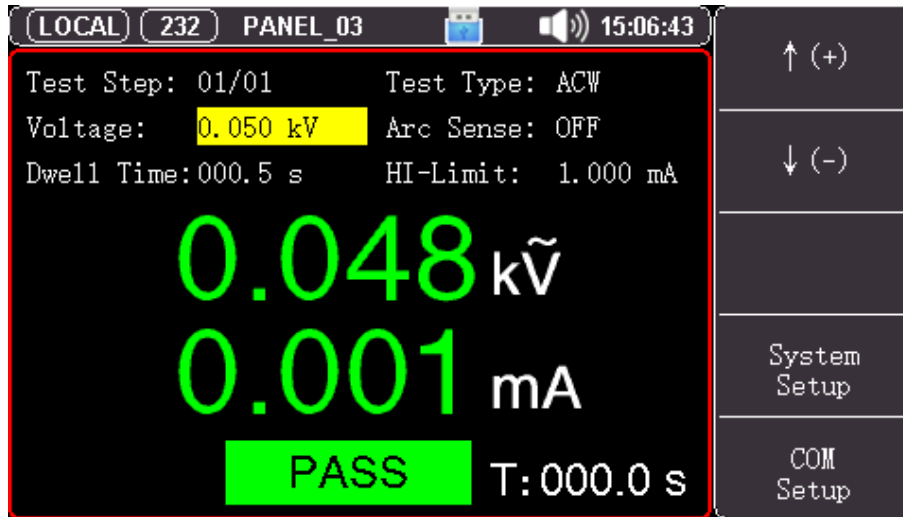

- 1) After the test is boot-up, two big characters displays on the middle of the screen is the real-time test data. The upper part is output voltage of high voltage, unit of withstand voltage is kV. The lower part is measured current value of the test low-end or insulation resistance value of DUT.
- 2) The middle area at the bottom of the screen is displays the test status and judgement result. The right side at the bottom of the screen is displays the left time of high voltage test. If user select the continuous test, then it will display the test time not greater than 999.9s.
- 3) Judgement of test result
 - a) For the withstand voltage test, the test result of the upper/lower limit of striking current can be judged at any time.
 - b) For the insulation resistance test, it will judge the result when the test time is near to close.
- 4) Description table of failed test and abnormal protection

Judgement Result	Description
Over the upper limit	It indicates the measured value is greater than the upper limit.
Over the lower limit	It indicates the measured value is less than the lower limit.
Short-circuit	The output current of the instrument is greater than the setting current limit of the internal, which is unalterable.
Electric arc	When testing AC/DC withstand voltage, the current arc is over the upper limit of electric arc.
Groud failed	Groud is break off and failed.
the lower limit of charge	When testing DC withstand voltage/insulation resistance, the current is lower than the setting minimum charge current.
Overvoltage	Output voltage is greater than the setting output voltage.

4.4 Screenshot

The instrument has screenshot function. Plug USB to the interface on the front panel of the instrument, press **[Print Sc]** key to screenshot the current screen's image and save it into USB for later use.

It is recommend to plug branded U flash disk to the interface of the instrument. The format is FAT32, maximum capacity 128G.

4.5 Lock Keyboard

In order to prevent to change the test condition accidentally, the instrument has lock keyboard function. Short press

[Lock] key on the panel to lock the keyboard; long press 1s **[Lock]** key to unlock the keyboard.

- a) In system setup, when adjustable mode is disabled, the instrument is only respond to START, STOP and LOCK key when the keyboard is locked.
- b) In system setup, when adjustable mode is enabled, the instrument is only respond to START, STOP, LOCK and fine tuning key of output voltage in <Measurement> page when the keyboard is locked.

5. Measurement [Setup]

This chapter includes the contents as follows.

- Editing the Test Steps
- Test Mode
- Parameter Setting of AC Withstand Voltage
- Parameter Setting of DC Withstand Voltage
- Parameter Setting of Insulation Resistance

When high voltage output is stop, press [Setup] key to directly enter the setting page of measurement.

5.1 Editing the Test Steps

Figure 5-1 【Meas Setup】

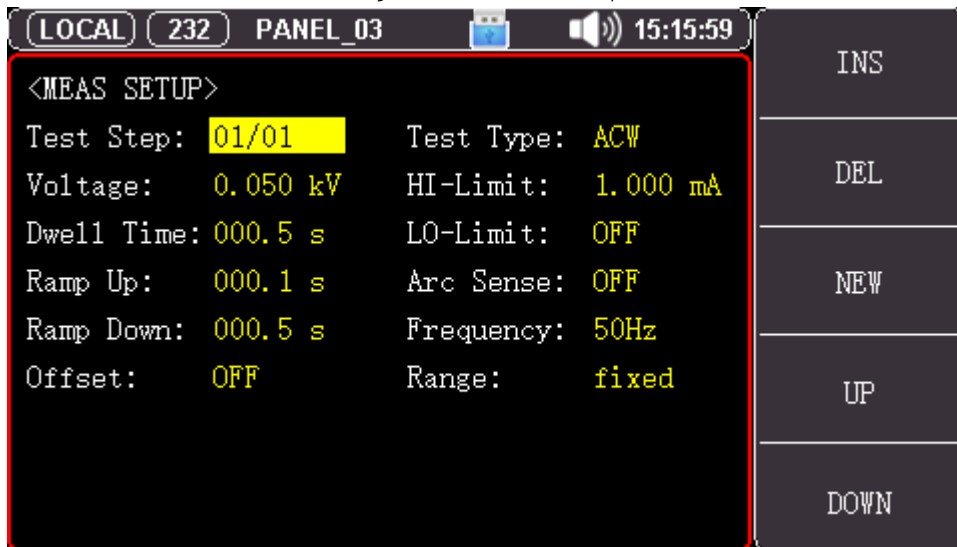

As shown in Figure 5-1, test step: 01/01 represents test step: the currently setting item number / total test item numbers.

The instrument is support the maximum total test item numbers are 20 steps.

■ Set Test Step

Step 1	Press [Measurement Setup] key to enter setup page;
Step 2	Use cursor key to select [Test Step] field;
Step 3	Use function key to select.

Function Key	Function
INS	Add a new test item after this item, the sequency of new added item and the following item move back one bit.
DEL	Delete the current test item, the sequency of the following item move forward one bit.
NEW	Create a new test plan, the syste, will automatically create a default test item.
UP	Access the parameter of the step preceding the current step.
DOWN	Access the parameter of the step following the current step.

5.2 [Test Mode] Setup

Press [Meas Setup] key to enter setup page, use cursor key to select [Test Type] field, and use function key to select

[ACW] to set the current item to AC withstand voltage test and all parameters sets to default value.

[DCW] to set the current item to DC withstand voltage test and all parameters sets to default value.

[IR] to set the current item to insulation resistance test and all parameters sets to default value.

5.3 Parameter Setting of AC Withstand Voltage

Figure 5-2 【Meas Setup】

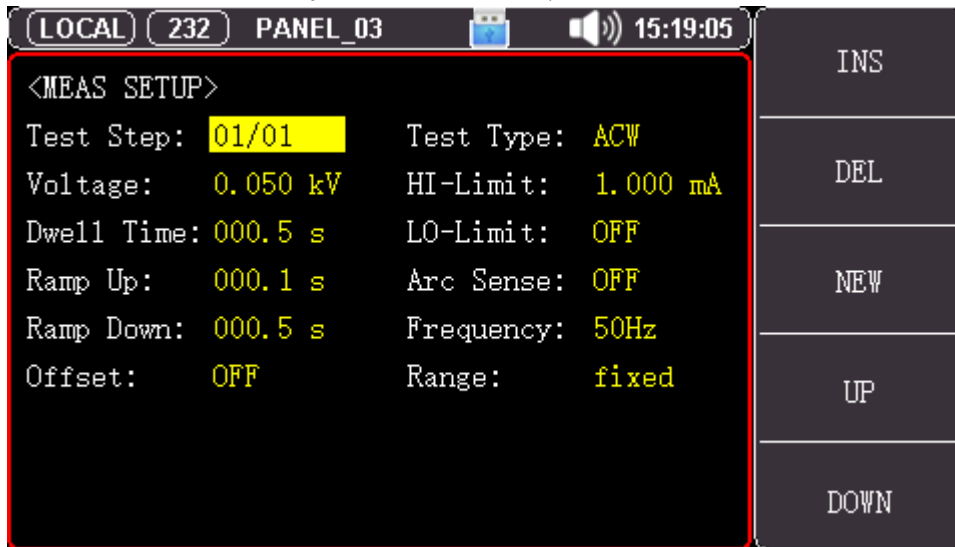

Item	Input Range	Default Value	Description		
Volatge	(0.050~5.000) kV	0.050kV	Output voltage during AC withstand voltage test.		
HI-Limit	(0.001~ 20.00) mA	1mA	UT5320R+/S4A/S8A, the upper limit of striking current alarm.		
	(0.001~ 10.00) mA		UT5310A/D/R+, the upper limit of striking current alarm.		
LO-Limit	0.001 mA~ the upper limit, OFF	OFF	The lower limit of striking current alarm.		
Dwell Time	(0.1~999.9)s, continous test	0.5 s	Test time of the currently setting item.		
Ramp Up	(0.1~999.9)s	0.5 s	Rated voltage to rising slowly based on this period.		
Ramp Down	(0.1~999.9)s, OFF	0.5 s	Rated voltage to falling slowly based on this period.		
Arc Sense	1~9 class, OFF	OFF	Alarm class of electric arc test. The size of electric arc alarm class can be preset and judge, the preset range is OFF, 1~9 class; OFF indicates the electric arc detection function is disabled, 9 class is the most sensitive, peak current of each alarm class as shown in the following table.		
				Class of Electric Arc	Threshold Peak Current (mA)
				9	2.8
				8	5.5
				7	7.7
				6	10
5	12				

			4	14
			3	16
			2	18
			1	20
Frequency	50 Hz, 60 Hz	50 Hz	Output frequency of AC withstand voltage.	
Range	Auto, fixed	Fixed	Set current scale to auto or fixed scale. If the current range sets to [Auto] , the instrument will automatically select the proper current scale. If the current range sets to [Fixed] , it is necessary to set a value at the upper limit of the current to determine the current scale, which aims to shorten the test time. It is the best way for sorting test.	
Offset	OFF, auto test	OFF	Set leakage current to zero clearing. Press [Auto Test] key on sidebar to automatically measure the leakage current of test wire and test fixture and to zero clearing. At this point, DUT must be removed from the test line. Press [OFF] key to clear.	

5.4 Parameter Setting of DC Withstand Voltage

Figure 5-3 【Meas Setup】

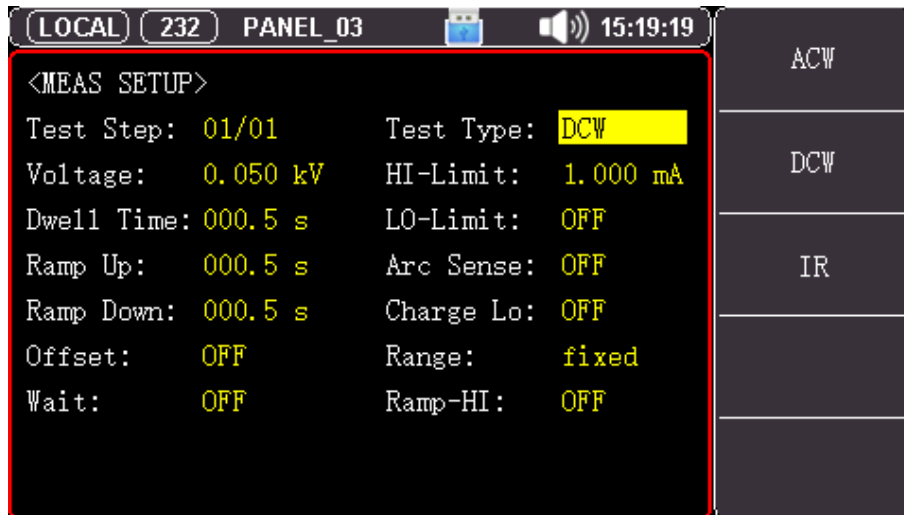

Item	Input Range	Default Value	Description
Volatge	(0.050~6.000) kV	0.060 kV	Output voltage during DC withstand voltage test.
HI-Limit	0.1uA ~ 10.00 mA	1 mA	UT5320R+/S4A/S8A, the upper limit of striking current alarm.
	0.1uA ~ 5.00 mA		UT5310A/D/R+, the upper limit of striking current alarm.
LO-Limit	0.1uA ~ the upper limit, OFF	OFF	The lower limit of striking current alarm.
Dwell time	(0.1~999.9)s, continous test	0.5 s	Test time of the currently setting item.
Ramp up	(0.1~999.9)s	0.5 s	Rated voltage to rising slowly based on this period.
Ramp down	(0.1~999.9)s, OFF	0.5 s	Rated voltage to falling slowly based on this period.
Arc sense	1~9 class, OFF	OFF	Alarm class of electric arc test.
Range	Auto, fixed	Fixed	Set current scale to auto or fixed scale.

			<p>If the current range sets to [Auto], the instrument will automatically select the proper current scale.</p> <p>If the current range sets to [Fixed], it is necessary to set a value at the upper limit of the current to determine the current scale, which aims to shorten the test time. It is the best way for sorting test.</p>
Offset	OFF, auto test	OFF	<p>Set leakage current to zero clearing.</p> <p>Press [Auto Test] key on sidebar to automatically measure the leakage current of test wire and test fixture and to zero clearing. At this point, DUT must be removed from the test line.</p> <p>Press [OFF] key to clear.</p>
Ramp-HI	OFF, ON	OFF	<p>During the judgement of rising, DC withstand voltage test will judge the value of current test whether is over the upper limit of striking current alarm.</p> <p>When the judgement of rising is disabled, DC withstand voltage test will not judge the value of current test whether is over the upper limit of striking current alarm.</p>
Wait	(0.1~999.9)s, OFF	OFF	<p>Waiting time of DC charge, waiting time to the judgement of the upper/lower limit of the current.</p> <p>Rising time < the set value of waiting judgement time < (rising time + test time) .</p>
Charge LO	OFF, Manual input (0.1-350) uA, auto test	OFF	<p>The setting of the minimum charge current.</p> <p>It is used to detect the test wire or test fixture whether is normal connected, to make sure the correctness of the test result. Since the leakage current is usually quite small during the DC withstand voltage test, so the lower limit of leakage current is hard to be the judgement to determine the test wire or test fixture is correctly connected.</p> <p>Since DUT is actually with some capacitive, so it can use charge current of DUT to detect the test wire or test fixture is normal connected. (The specific steps refer to the parameter setting of insulation resistance.)</p>

5.5 Parameter Setting of Insulation Resistance

Figure 5-4 【Meas Setup】

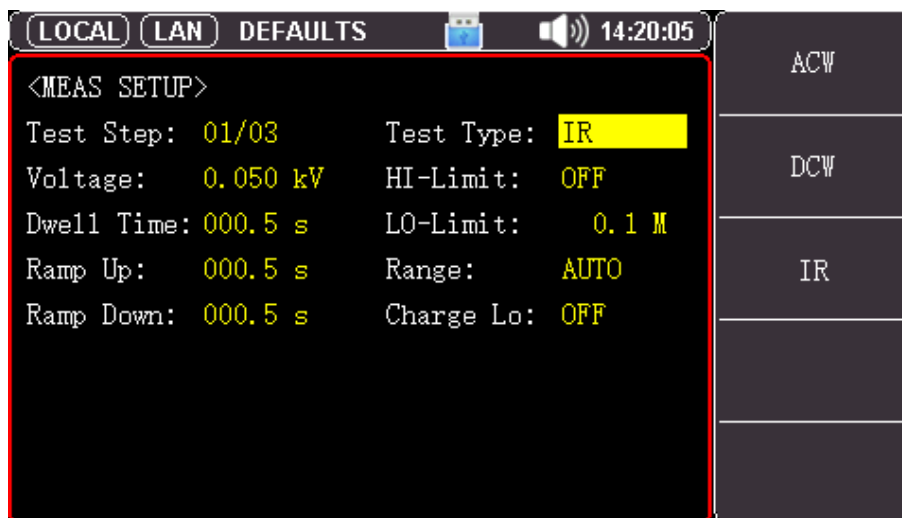

Item	Input Range	Default Value	Description
Voltage	(0.050~2.500) kV	0.050 kV	Output voltage during the insulation resistance test.
HI-Limit	The lower limit of resistance~10.00 G, OFF	OFF	The upper limit of the insulation resistance alarm.
LO-Limit	0.1M ~ 10.00 G	0.1M	The lower limit of the insulation resistance alarm.
Dwell Time	(0.1~999.9)s, continuous test	0.5s	Test time for delay judgement of insulation resistance test.
Ramp Up	(0.1~999.9)s	0.5s	Rated voltage to rising slowly based on this period.
Ramp Down	(0.1~999.9)s, OFF	0.5s	Rated voltage to falling slowly based on this period.
Range	Auto, fixed	Auto	Set current scale to auto or fixed scale. If the current range sets to [Auto] , the instrument will automatically select the proper current scale. If the current range sets to [Fixed] , it is necessary to set a value at the lower limit of the resistance to determine the current scale, which aims to shorten the test time. It is the best way for sorting test.
Charge Lo	OFF, manual input (0.1~350) uA , auto test	OFF	The setting of the minimum charge current. It is used to detect the test wire or test fixture whether is normal connected, to make sure the correctness of the test result. Since the leakage current is usually quite small during the insulation resistance test, so the lower limit of leakage current is hard to be the judgement to determine the test wire or test fixture is correctly connected. Since DUT is actually with some capacitive, so it can use charge current of DUT to detect the test wire or test fixture is normal connected. <ul style="list-style-type: none"> ● Use numeric keyboard to input the numerical value of the minimum charge current by manual. ● To automatically set the numerical value of the minimum charge current, please connect the instrument and DUT with test line or fixture, and make sure that the parameters of output voltage and slow rise time are completely consistent with the actual test data.

Explanation

- 1) The judgement of the upper/lower limit of resistance is only enabled when the delay judgement time is end, other time is to detect abnormal protection.

- 2) Test result explanation of insulation resistance test
 - a) The instrument's display format: if the display value is greater than 10 G, it will display as >10.0 GΩ.
 - b) The insulation value is read by the interface, the default unit is M. When then instrument displays >10.0GΩ, it will read out the value which greater than 10 G. It's only for reference.

5.6 Parameter Setting of Contact-Inspecting (Only for UT5320R-S4A/UT5320R-S8A)

Figure 5-5 【Meas Setup】

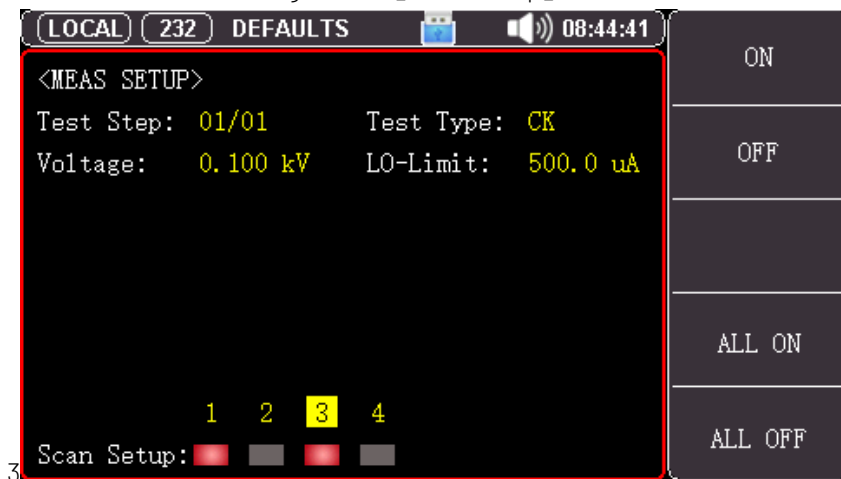

Item	Input Range	Default Value	Description
Voltage	(0.050~0.500)kV	0.100 kV	Output voltage during touch-inspecting test. Except in special circumstances, use the default setting in general.
LO-Limit	0.1uA ~ 1.00 mA	500 uA	The lower limit of touch-inspecting alarm. Except in special circumstances, use the default setting in general.
Scan Setup	ON, OFF	OFF	UT5320R-S4A can control channel 1, 2, 3, 4; UT5320R-S8A can control channel 1, 2, 3, 4, 5, 6, 7, 8;

5.7 Scanning Setting of Multi-Channel (Only for UT5320R-S4A/UT5320R-S8A)

Figure 5-6 【Meas Setup】

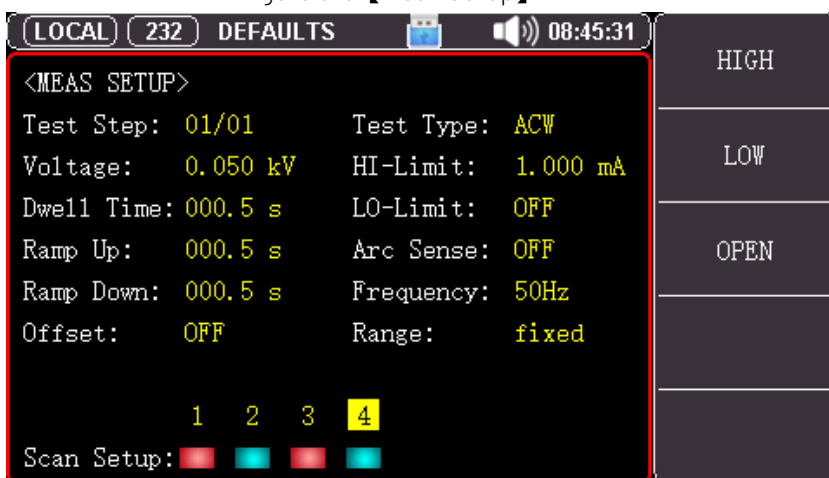

When UT5320R-S4A/S8A is in the test mode of AC withstand voltage, DC withstand voltage, insulation resistance, which can configure the scanning channel of multiple channels.

Item	Input Range	Default Value	Description
Scan Setup	HIGH, LOW, OPEN	OPEN	UT5320R-S4A can control channel 1, 2, 3, 4; UT5320R-S8A can control channel 1, 2, 3, 4, 5, 6, 7, 8;

5.7.1 Multi-channel module

Multi-channel output is a built-in high voltage switching module attached to the lower part of the instrument. Through the multi-channel output module, multiple points of the component to be tested can be connected with multiple channels of the instrument at one time. During the test, the instrument controls the channel switch according to the user-defined, and connects the corresponding port to the voltage resistant test end to realize controllable test. The characteristic of this test is that user can realize the fast connection through the test fixture, and it does not need to switch the interface during the test, so that the test is safe and reliable.

UT5320R-S4A/UT5320R-S8A has touch-inspecting function, its multi-channel test wires are double-wire ports.

Each channel's port of the double-wire port has two lead outputs, of which the thicker plug is the high-voltage lead during the test; the thinner plug is the current sampling lead during the test. A resistance of more than 1MΩ is built-in between the two lines, which is used as the self-test standard of the port. In general, two lines must be short-circuited as a port. If the test current passes through the built-in resistance, the built-in resistance will be damaged and cause the test data current limiting error.

In contact-inspecting mode (CK function): the two test wires of the same port must be connected with the two contacts of the same conductor of DUT respectively, and the instrument detects whether the port is conducted and confirm whether the element is installed in place.

Figure 5-7 Multi-Channel Connecting

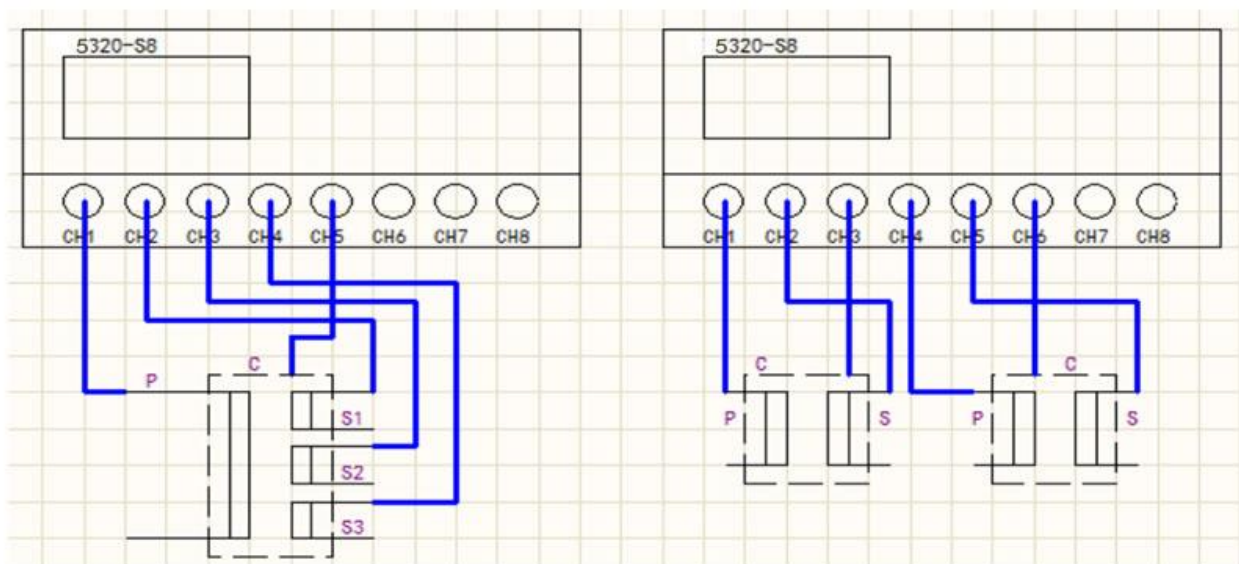

Notes

1. In the multi-channel status, the output port of the original hipot tester is still has the original function. It can be used as a public end.
2. Output port connecting of the multi-channel is set by user-defined. Do not connect redundant high voltage connection when in using, in order to prevent the dangerous.

6. System Setup

This chapter includes the contents as follows.

Page Explanation of <SYSTEM 1>

Page Explanation of <SYSTEM 2>

Page Explanation of <System Information>

6.1 <System> Setup

<System Setup> page is to set some settings that are not related to the specific test item parameters, but are related to the test scheme of the instrument.

When high voltage output is stop, press [System Setup] key to enter <SYSTEM 1> page.

Figure 6-1 <System Setup 1> Page

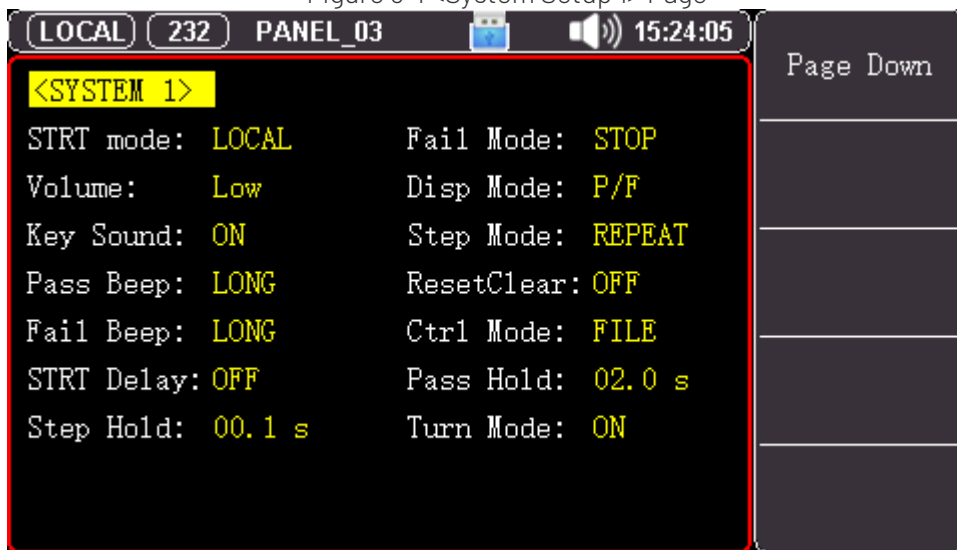
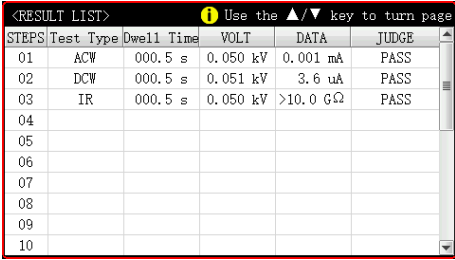
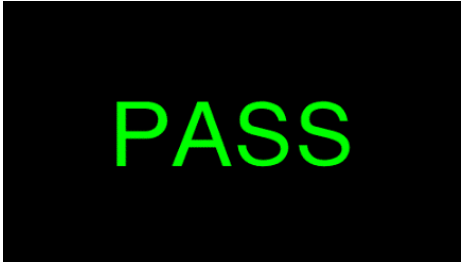
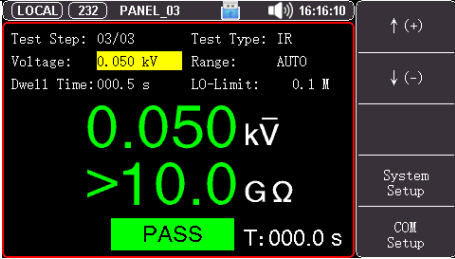

Table 6-1 Explanation of <SYSTEM 1> Page

Item	Input Range	Default Value	Description
Start mode	Local, PLC	Local	① Local: Press start key on the front panel to boot-up. ② PLC: Input START control signal by HANDLER to boot-up ③ Communication: It's always valid, the specific refer to the communication protocol.
Volume	Low, middle, high	Middle	The volume setting of beeper.
Key sound	ON, OFF	ON	The switch of key sound.
Pass beep	Long and short sound, double short sound, OFF	Long and short sound	The sound mode of pass beeper.
Fail beep	Long sound, double short sound, OFF	Long sound	The sound mode of failed beeper.
Start delay	(0.1~99.9)s, OFF	OFF	The delay time from start to the first test item.

Step Hold	(0.1~99.9)s, key control	0.1 s	<p>① (0.1~99.9)s: In multi-step test, the waiting time between the steps.</p> <p>② Key control: Press [START] key to start the next step.</p>																																																																		
Fail mode	Stop, continue, retest, next step	Stop	<p>① Stop: If the test is failed, then stop all the test.</p> <p>② Continue: Stop the current test and perform the next step.</p> <p>③ Retest: Stop the current test and press [START] key to retest the current step which is failed.</p> <p>④ Next step: Stop the current test and press [START] key to start the next step.</p>																																																																		
Disp mode	All, the last step, P/F	All	<p>① Select "All" mode</p> <p>When performe a multi-step test, the test results of "All" will displayed after the test is finished. The display is as follows (toggle the up and down cursor key to switch the display) :</p>  <table border="1" data-bbox="874 920 1331 1178"> <thead> <tr> <th>STEPS</th> <th>Test Type</th> <th>Dwell Time</th> <th>VOLT</th> <th>DATA</th> <th>JUDGE</th> </tr> </thead> <tbody> <tr> <td>01</td> <td>ACW</td> <td>000.5 s</td> <td>0.050 kV</td> <td>0.001 mA</td> <td>PASS</td> </tr> <tr> <td>02</td> <td>DCW</td> <td>000.5 s</td> <td>0.051 kV</td> <td>3.6 uA</td> <td>PASS</td> </tr> <tr> <td>03</td> <td>IR</td> <td>000.5 s</td> <td>0.050 kV</td> <td>>10.0 GΩ</td> <td>PASS</td> </tr> <tr> <td>04</td> <td></td> <td></td> <td></td> <td></td> <td></td> </tr> <tr> <td>05</td> <td></td> <td></td> <td></td> <td></td> <td></td> </tr> <tr> <td>06</td> <td></td> <td></td> <td></td> <td></td> <td></td> </tr> <tr> <td>07</td> <td></td> <td></td> <td></td> <td></td> <td></td> </tr> <tr> <td>08</td> <td></td> <td></td> <td></td> <td></td> <td></td> </tr> <tr> <td>09</td> <td></td> <td></td> <td></td> <td></td> <td></td> </tr> <tr> <td>10</td> <td></td> <td></td> <td></td> <td></td> <td></td> </tr> </tbody> </table> <p>② Select "The last step" mode</p> <p>When perform a single test or multi-step test, the test when result of "the last group" will displayed after the test is finished. The display is as follows.</p>  <p>③ Select "P/F" mode</p> <p>When perform a single test or multi-step test, the test result of "Pass" or "Fail" will displayed after the test is finished. The display is as follows.</p>	STEPS	Test Type	Dwell Time	VOLT	DATA	JUDGE	01	ACW	000.5 s	0.050 kV	0.001 mA	PASS	02	DCW	000.5 s	0.051 kV	3.6 uA	PASS	03	IR	000.5 s	0.050 kV	>10.0 GΩ	PASS	04						05						06						07						08						09						10					
STEPS	Test Type	Dwell Time	VOLT	DATA	JUDGE																																																																
01	ACW	000.5 s	0.050 kV	0.001 mA	PASS																																																																
02	DCW	000.5 s	0.051 kV	3.6 uA	PASS																																																																
03	IR	000.5 s	0.050 kV	>10.0 GΩ	PASS																																																																
04																																																																					
05																																																																					
06																																																																					
07																																																																					
08																																																																					
09																																																																					
10																																																																					

			
Step mode	Normal, cycle, single	Normal	<ul style="list-style-type: none"> ① Normal: The normal test mode of the instrument. ② Cycle: Automatic cycle after the file test is finished. ③ Single: Only test the current step.
ResetClear	OFF, ON	OFF	<ul style="list-style-type: none"> ① When the reset is enabled and the test is failed, press [STOP] key and then press [START] key to continue the test. ② When the reset is disabled and the test is failed, press [START] key to continue the test.
Ctrl mode	File, single step	File	<ul style="list-style-type: none"> ① File: When file test is finished, HANDLER interface outputs the test result. ② Single Step: After each step is finished, HANDLER interface outputs the test result of the current step.
Pass Hold	(0.1~99.9)s, key control	Key control	<ul style="list-style-type: none"> ① (0.1~99.9)s: When the test is qualified, hold time of the qualified judgment. ② Key control: When the test is qualified, and the test is qualified, press [STOP] key to end.
Turn Mode	OFF, ON	OFF	<ul style="list-style-type: none"> ① OFF: Output voltage cannot be change during the test ② ON: The size of output voltage can be fine tuning.

6.2 <Communication Setup>

<Communication Setup> page is to set the language, date, time and the communication setting. Press [Communication Setup] to enter <SYSTEM 2> page.

Figure 6-2 <SYSTEM 2> Page, Select RS232 Mode



Figure 6-3 <SYSTEM 2> Page, Select LAN Mode

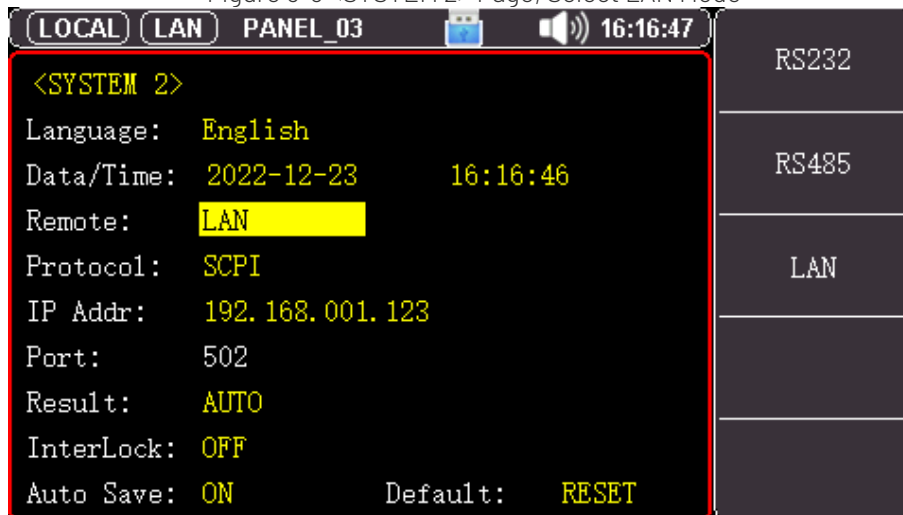

Table 6-2 Explanation of < SYSTEM 2 >

Item	Input Range	Default Vaule	Description
Language	English, Chinese	Chinese	Select the language for the instrument.
Date/time			The instrument is adopt 24 hours clock, use this key to modify date and time.
Remote	RS232, RS485, LAN	RS232	The instrument supports three interfaces: RS232, RS485 and LAN.
Protocol	SCPI, MODBUS	SCPI	The instrument supports two communication protocols: SCPI and Modbus (RTU), it usually use SCPI protocol to communicate with PC; use Modbus protocol to communicate with PLC industry control device.
Baud rate	9600, 19200, 38400, 57600, 115200	9600	Baud rate of serial bus.

Address	0~32	1	If use Modbus(RTU) protocol, please set the station address of this instrument: ① The instrument allows use the station number 00 to broadcast communication. ② 1~32: The address for connecting the instrument's bus.
Result	FETCH?, auto	Auto	This function is only for SCPI protocol. The instrument supports send data to the host automatically. The data will be sent to the host automatically after each test, and don't need the host to send FETCH? instruction.
InterLock	ON, OFF	OFF	The safety lock function prevents the test from running unless the safety lock pin on the signal I/O port connector is short-circuited. Attached pluggable terminal can be used for this purpose to facilitate wiring. The details refer to Chapter 8.2.
IP addr	192.168.001.123		When communication mode is TCP, use numeric keyboard to change the parameter.
Port		502	It is the default value and cannot be change. It will be used when the communication mode is TCP.

6.2.1 Reset to factory setting

All settings of the instrument will reset to the factory setting.
<File Management> page is preset to file 1.

6.3 <System Information>

Enter <SYSTEM 2> page, press function key to select [**System Information**].
The information includes model name, serial number and version of the instrument.
This page don't need to setup.

Figure 6-3 <System Information> Page



7. File Management

This chapter includes the contents as follows.

- [Storage]
- [Boot-up Recall]
- File Operating

7.1 File Management

When high voltage output is stop, press [Save] key to enter <File> page.

Figure 7-1 <File Management> Page

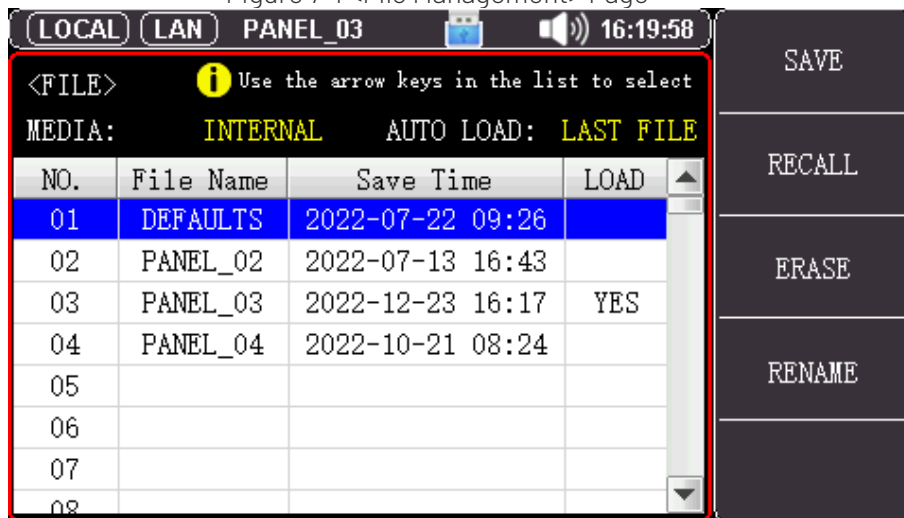

7.1.1[Media]

Storage function is select the file from the instrument's internal or external U flash disk. The instrument's internal can access 100 files, U flash disk can access 20 files.

7.1.2[Auto Load]

Boot-up recall function can assign the call file when the instrument is boot-up, it has two options: file 1 and the current file.

If select the file 1, then load the setting value of file 1 when the instrument is boot-up;

The setting steps:

1. Enter <File> page;
2. Use cursor key to select [Auto load] filed;
3. According to the need to select file 1 or the current file by the function key on the screen.

7.1.3[File 1]~[File 100]

User can assign 1~100 files to save, read and delete.

Function Key	Function Description
Save	Save all the settings into the current file.
Recall	Read the parameter of the file to the system.
Erase	Delete the file data.
Rename	Rename the file name, it can be user-defined.

The Setting Steps:

1. Enter <File> page;
2. Use cursor key to select [File 1]~[File 100] any filed need to be set;
3. According to the need to select save, read and delete by the function key on the screen.

7.1.4 Rename File Name

Figure 7-2 Rename File Name

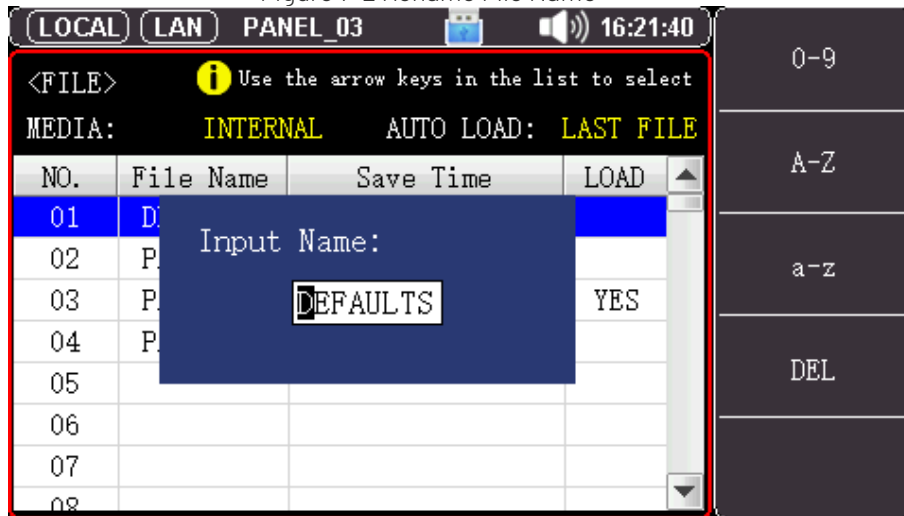

- Press left or right direction key to move the cursor;
- F1, F2, F3, F4 can respectively to select the character range and operation;
- Press up or down direction key to select and display the character (support long press);
- Press ENTER key to confirm the change; press ESE key to cancel the change.

7.1.5 Recall File Copy

It's convenient for user to quickly batch set the instrument, and the instrument supports save the setting information to external U flash disk. Other instrument can read the required parameter from U flash disk. U flash disk supports a maximum of 20 external files.

In test interface, press [Save] to select the storage to U flash disk. Select blank serial number, and then press [Save] to save the setting to U flash disk.

Figure 7-3 USB File Storage

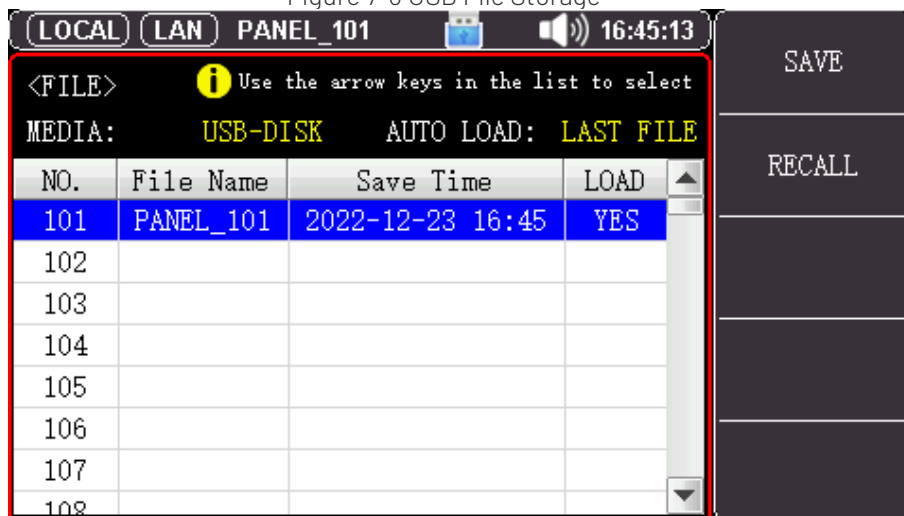

8. Processor Handler Interface

This chapter includes the contents as follows.

- HANDLER Interface
- SIGNAL Interface

8.1 HANDLER Interface

This series of tester is equipped with a 9PIN D connection terminal, which provides remote input control and output signals.

In order to get the best performance, it is recommended to use a shielded wire as the connection line of the input control and output signal.

Figure 8-1 HANDLER Interface

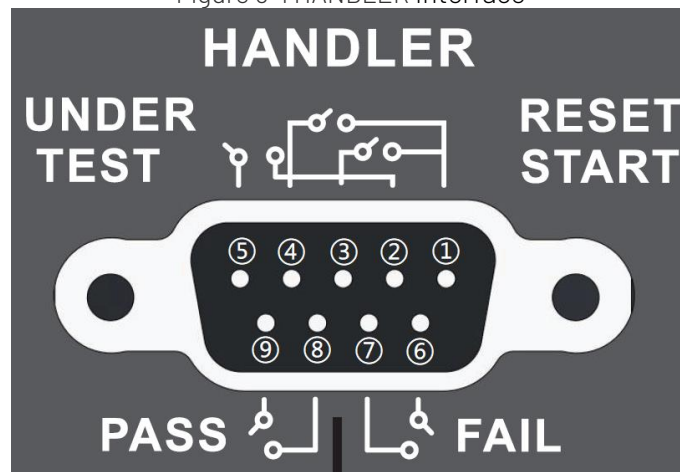

If need to use HANDLER function, the start mode must be PLC.

When the start mode is PLC, START switch on the frone panel cannot be operate. It's to avoid repeat operating cause error action and dangerous. STOP key can be operate, it's to turn off high voltage output at anywhere.

Table8-1 Definition of HANDLER

Input/Output	Pin	Name	Function Description
Signal input	1	COM (common low-end)	It provides 0V signal for start and stop.
	3	START signal	The instrument starts the test when START is short-circuited with COM.
	4	RESET (STOP) signal	The instrument stop the test when START is short-circuited with COM.
Signal ouput	2	TEST1	When the instrument is testing, TEST 1 is short-circuited with TEST2. When the test is finished , TEST1 is open-circuited with TEST2.
	5	TEST2	
	8	PASS1	When the instrument is testing, PASS1 is open-circuited with PASS2. When the test is pass, PASS1 is short-circuited with PASS2.
	9	PASS2	
	6	FAIL1	When the instrument is testing, FAIL1 is open-circuited with FAIL2. When the test is failed, FAIL1 is short-circuited with FAIL2.
7	FAIL2		

Figure 8-2 Time Sequence of HANDLER

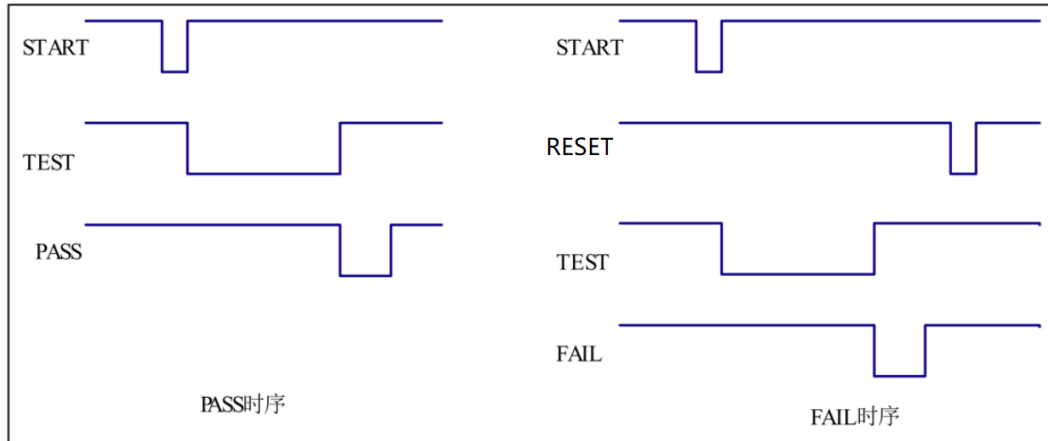

Table 8-2 Time Sequence of HANDLER

Signal	Description
Use HANDLER interface to start the test	<ol style="list-style-type: none"> 1. Judge whether the TEST (under testing) signal on the interface is valid. Only when the TEST (under testing) signal is invalid can the START signal be received. 2. When meet the first rule is met, the test can be started by sending START signal with a width of 40ms ~ 200ms (i.e. the closing time of the switch quantity).
Use HANDLER interface to stop the test	At any time, send the RESET signal with a width of 40ms ~ 200ms (i.e. the closing time of the switching quantity) to stop the test.
Signal output—under testing	The relay will connect PIN2 and PIN5 when the instrument is testing. After the test is completed, the relay will return PIN2 and PIN5 to the open-circuit state.
Signal output—test is pass	<p>When DUT test is pass, relay will connect PIN8 and PIN9 and hold the state.</p> <p>When other test program starts to test, or press the stop swith, relay will return PIN8 and PIN9 to the open-circuit state.</p>
Signal output—test is failed	<p>When DUT test is failed, relay will connect PIN6 and PIN7 and hold the state.</p> <p>When other test program starts to test, or press the stop swith, relay will return PIN6 and PIN7 to the open-circuit state.</p>



- All the input signals are input by switch value, other voltage or current source must not be connected. If input other power, will cause the instrument internal control circuit damage or misoperation.
- When the external control signal (signal output) needs to pass the voltage or current greater than 220V or 2A, the internal relay of the instrument will not be able to bear it. Please transfer it by yourself.

8.2 SIGNAL Interface

Figure 8-3 SIGNAL Interface

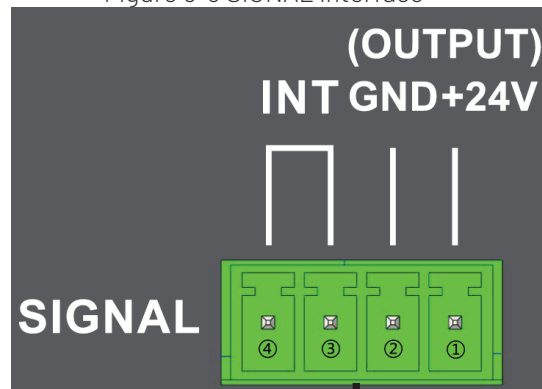

- 1) SIGNAL interface provides a power supply with an approximate output voltage of +24V (1 pin is +24V and 2 pin is ground), output current is less than 0.5A and coordinate with HANDLER interface to control signal for indicator light, optoelectronic switch and low power solenoid valve.



- This power is the the internal power of the instrument, AC current is output via rectifier filter, no stabilized voltage about 24V, please confirm it befor using.
- The maximum transient current cannot be greater than 0.5A, and the long-term working current cannot be greater than 0.2A. If a larger current is required, please prepare a power supply.

- 2) 3 pin and 4 pin of SIGNAL interface is online lock signal,
<System Setup 2> page, if [**Safety Lock**] function is enabled, then online lock signal should provide by the external.

Online lock signal only works when it is short circuit. Attached pluggable terminal is convenient for users to connect wire.

If the online lock signal is open circuit, then then instrument will be locked and cannot to start or stop the test.

"INTERLOCK OPEN!" will also display on the measurement page.

Figure 8-4 Interlock Open

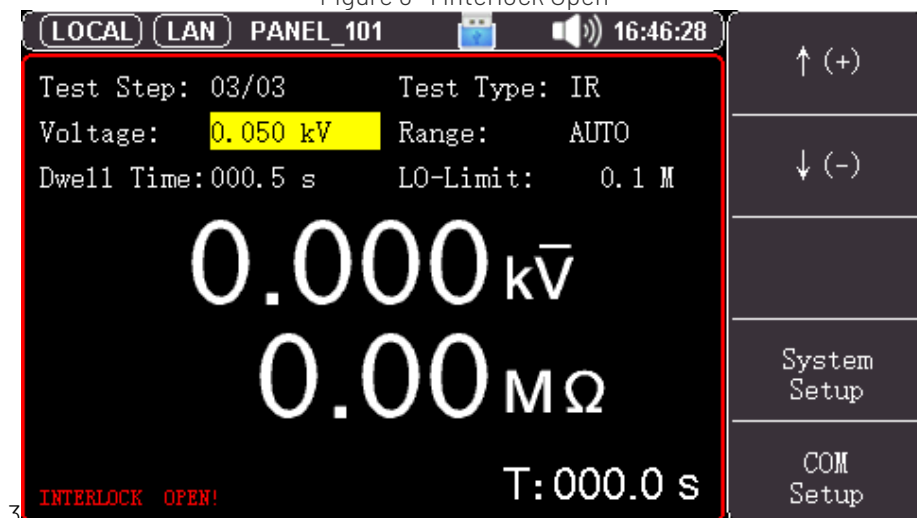

9. Remote Communication

This chapter includes the contents as follows.

- Interface Setting of RS-232C
- Interface Setting of RS-485
- Interface Setting of LAN

9.1 RS-232C Interface Setting

9.1.1 RS-232 Interface

RS-232 is widely used serial communication standard, it's also called asynchronous serial communication standard. It's used to realize data communication between computers and peripherals. RS is English abbreviation of "Recommended Standard", 232 is standard number. The criterion is officially published by Electronic Industries Alliance (EIA) in 1969. It requires that each bit should via a data line to transmit.

But the configuration of most serial ports is usually not strictly based on the RS-232 standard: a 25-core connector is used in each port (today's computers basically use a 9-core connector). The common RS-232 signal as shown in the following table.

Table 9-1 Common RS-232 Signal

Signal	Symbol	Pin number of 25-core connector	Pin number of 9-core connector
Request to send	RTS	4	7
Clear to send	CTS	5	8
Data set ready	DSR	6	6
Data carrier detect	DCD	8	1
Data terminal ready	DTR	20	4
Transmit data	TXD	2	3
Receive data	RXD	3	2
Ground	GND	7	5
Request to send	RTS	4	7

In addition, there is a minimal subset of RS232, which the connecting way of the instrument.

Table 9-2 Standard Minimum Subset of RS-232

Signal	Symbol	Pin number of 9-core connector
Transmit data	TXD	2
Receive data	RXD	3
Ground	GND	5

9.1.2 RS-232 Connecting



Suggestion: In order to prevent electric shock, please turn off the power when plug the connector.

Figure 9-1 RS-232 Connector, D-sub 9 Pin Male Head

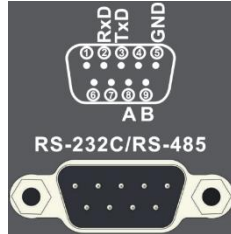

When connect the instrument to PC, use D-sbu 9 pin femal head to connect the crosswire of D-sbu 9 pin femal head

- The default communication setting of the instrument
 Transmit mode: full duplex asynchronous communication with start and stop bit
 Baud rate: [Baud Rate] setting in <System Setup 2> page
 Data bit: 8 bits
 Stop bit: 1 bit
 Parity bit: no

9.2 RS-485 Interface Setting

The instrument selects RS485 interface and support ModBus RTU protocol.

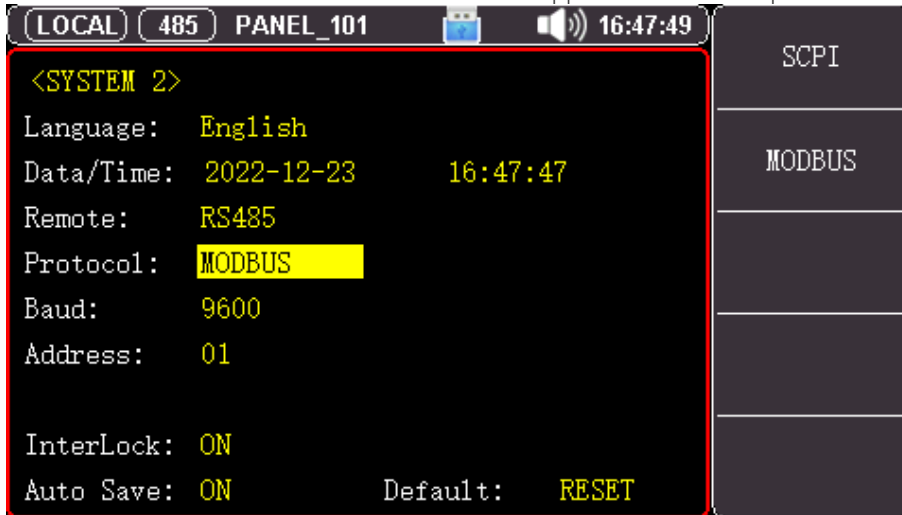

The instrument's station number can set to 1~32 in <System Setup2>, station number of multi-salve is different; RS485 is a communication interface support multi-machine communication, it can connect multi-machine via one host.

RS485 of the instrument and RS232 shares a DB9 terminal, as shown in Figure 9-1

Pin	Function
8	A
9	B

9.3 LAN Interface Setting

Figure 9-2 LAN Connector on the Rear Panel

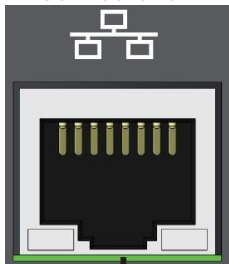

Connect LAN cable to the LAN connector of the instrument.
 Green LED –Illuminated: connecting Blinking: communicating
 Orange LED –Extinguished: 10BASE-T Illuminated: 100BASE-TX

9.3.1 Select LAN Communication Mode

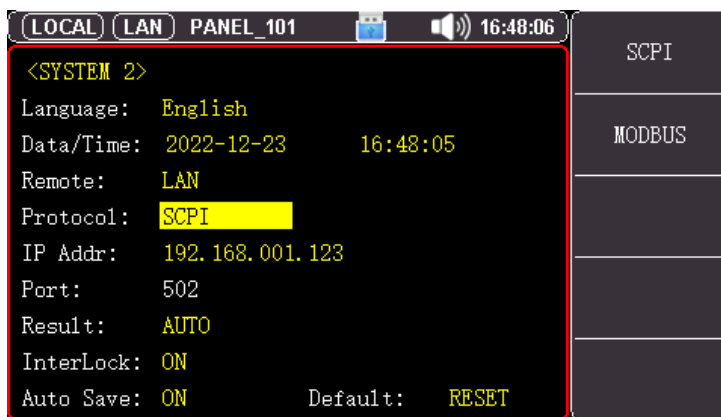

Move cursor to [Communication Mode] field, use function key to select LAN.

9.3.2 Set IP Address

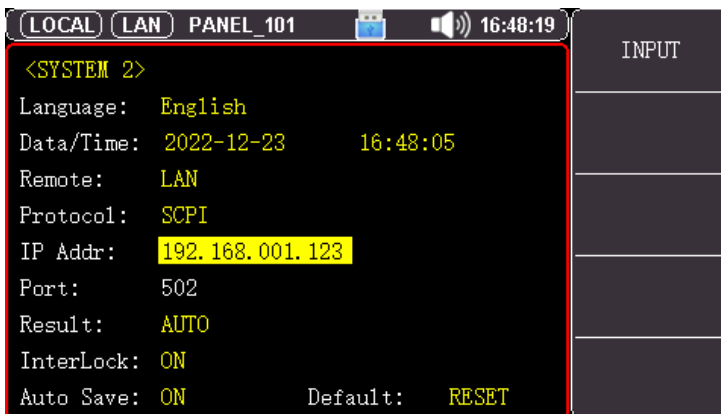

Move cursor to [Communication Mode] field, use function key to select;
 Then use numeric keyboard to input;
 And then press ENTER key to confirm the change; press ESE key is to cancel the change.

10. Specification

This chapter includes the contents as follows.

- Technical Index
- Model and Function
- Environmental Requirement

10.1 Technical Index

Model		UT5310A+	UT5310D+	UT5310R+	UT5320R+/S4A/S8A	
Withstand Voltage Test						
Output Voltage	AC	Voltage Range	0.050kV–5.000kV		0.050kV–5.000kV	
		Voltage Wave	Sine wave		Sine wave	
		Distortion	< 3%		< 3%	
		Operating Frequency	50, 60Hz (optional)		50, 60Hz (optional)	
		Accuracy of Frequency	±1%		±1%	
		Output Power	50VA (5.000kV 10mA)		100VA (5.000kV 20mA)	
		Regulated rate of Voltage	±(1.0%+50V)(rated power)		±(1.0%+50V) (rated power)	
	DC	Voltage range		0.050 kV–6.000kV		0.050 kV–6.000kV
		Frequency of Signal Source		600Hz		600Hz
		Output Power		30VA (6.000kV 5mA)		60VA (6.000kV 10mA)
		Regulated rate of Voltage		± (1.0% +100V)(rated power)		± (1.0% +100V) (rated power)
	AC/DC	Resolution of Voltage		1V		1V

Note: Guarantee period of precision is one year.

		Output Accuracy of Voltage		$\pm(1.0\% \text{ Setting} + 5V)$ (no load)	$\pm(1.0\% \text{ Setting} + 5V)$ (no load)
		Test Accuracy of Voltage		$\pm(1.0\% \text{ Reading} + 5V)$	$\pm(1.0\% \text{ Reading} + 5V)$
		Producing Mode of Voltage		DDS signal source plus AB power amplifier	DDS signal source plus AB power amplifier
Current Test Range	AC	Current Range	0.001mA - 10mA		0.001mA - 20mA
		Short-circuit Current	>20 mA		>40 mA
		(Transient)	(output voltage setting >500V)		(output voltage setting >500V)
		Resolution of Current	0.001 mA		0.001 mA
		Accuracy of Current	$\pm(2.0\% \text{ Reading} + 5 \text{ characters})$		$\pm(2.0\% \text{ Reading} + 5 \text{ characters})$
		Actual Current	OFF, 0.001 mA-10mA		OFF, 0.001 mA-20mA
	DC	Current Range		0.1uA - 5.00mA	0.1uA - 10.00mA
		Accuracy of Current		$\pm(2.0\% \text{ Reading} + 5 \text{ characters})$	$\pm(2.0\% \text{ Reading} + 5 \text{ characters})$
		Discharge		Automatically discharge after the test is finished	Automatically discharge after the test is finished
Insulation Resistance Test					
Output Voltage				0.050kV-2.500kV (optional 5.00kV)	0.050kV-2.500kV(optional 5.00kV)
Resolution of Voltage				1V	1V
Test Accuracy of Voltage				$\pm(1.0\% \text{ Reading} + 2V)$	$\pm(1.0\% \text{ Reading} + 2V)$
Maximum Output Current				5mA	10mA
Maximum Output Power				12.5VA (2500V/5mA)	25VA (2500V/10mA)
Output Transient Short-circuit Current				>10mA (output voltage setting >500V)	>20mA(output voltage setting >500V)

On-load Regulated Rate				$\leq 1\%$ (rated power)	$\leq 1\%$ (rated power)
Ripple Wave (1kV)				$\leq 3\%$ (1kV, no load)	$\leq 3\%$ (1kV, no load)
Discharge				Automatically discharge after the test is finished	Automatically discharge after the test is finished
Test Range of Resistance				0.2M Ω - 10G Ω	0.1M Ω - 10G Ω
Display Range of Resistance(1000V)				5mA 0.2 M Ω -1 M Ω 1mA 1 M Ω -10 M Ω 100uA 10 M Ω -100 M Ω 10uA 100 M Ω -1G Ω 1uA 1G Ω -10G Ω	10mA 0.1 M Ω -0.5 M Ω 2mA 0.5 M Ω -5 M Ω 200uA 5 M Ω -50 M Ω 20uA 50 M Ω -500 M Ω 2uA 500 M Ω -10G Ω
Test Accuracy of Resistance				>500V 1M Ω -1G Ω $\pm(5\%$ Reading +5 characters) 1G Ω - 10G Ω $\pm(10\%$ Reading+5 characters) < 500V 0.2M Ω -1G Ω $\pm(10\%$ Reading+5 characters) 1G Ω -10G Ω only for reference,no requirements	$\geq 500V$ 1M Ω -1G Ω $\pm(5\%$ Reading+5 characters) 1G Ω - 10G Ω $\pm(10\%$ Reading+5 characters)) < 500V 0.1M Ω - 1G Ω $\pm(10\%$ Reading+5 characters)) 1G Ω - 10G Ω only for reference, no requirements
Test Accuracy of Current				$\pm(1.5\%$ Reading + 5 characters)(after zeroing)	$\pm(1.5\%$ Reading + 5 characters)(after zeroing)
Electric Arc Detection					
Test Range	AC	OFF, 1-9 class			
	DC	OFF, 1-9 class			
Comparator					
Judgement Mode		Window's Compare Mode			

		I down ON: when $I_{down} < I_x < I_{up}$, PASS;	
		When $I_x \leq I_{down}$ or $I_x \geq I_{up}$, FAIL; (condition $I_{down} < I_{up}$)	
		I down OFF: when $I_x < I_{up}$, PASS; when $I_x \geq I_{up}$, FAIL;	
		The judgement mode of insulation resistance is the same as above.	
Current upper limit of I_{up}	AC	0.001mA - 10mA	0.001mA - 20mA
	DC	0.1uA - 5mA	0.1uA - 10mA
Current upper limit of I_{down}	AC	0.001mA - 10mA	0.001mA - 20mA
	(LOWER OFF) DC	0.1uA - 5mA	0.1uA - 10mA
Upper Limit of Resistance		OFF, 0.1MΩ - 10GΩ	OFF, 0.1MΩ - 10GΩ
Lower Limit of Resistance		0.1MΩ- 10GΩ	0.1MΩ- 10GΩ
Judgement Output		PASS/FAIL and LCD, sound alarm	
Parameter Setting			
Rising Time of Voltage		0.1s - 999.9s	
Falling time of Voltage		0 s - 999.9s, (Only when withstand voltage is pass)	
Waiting Time of Voltage		0.3s - 999.9s (Only in DC withstand voltage and meet the rising time+ test time > waiting time)	
Test Time		0.1s - 999.9s (When in TIMER ON)	
Accuracy of Time		± (0.2% Setting ± 0.1s)	
Measurement Function			
Keyboard Lock		Preventing accidental modification of test condition, or forbid the test condition from being modified.	
Zero Clearing		Current flowing through the insulation resistance and distributed capacitance between the output lines can be cleared to zero.	
Boot-up Delay		When start to test (press START) , output high voltage start signal, and then wait for while to output high voltage.	
Judgment of Current Overrange		Hardware can quickly judge the insulation breakdown. It's quick and safety than voltage sampling and reducing the shokc damage to the product.	
ARC Detection		Singular signal of sampling current is to judge the potential risk and size in loop.	
Ground Current Detection		Protect people from electric shock and leakage.	
Volume Adjustment		OFF, low, middle, high	
High Voltage Indicator		Window indicator and LED	
Storage and Interface			
File programming and Storage		It can programe 100 test files, each file can have 20 test projects.	

USB HOST Interface	√ (128G)
Save Boot-up Paramete	The setting parameter save as the default parameter, it can be automatic reload when next boot-up.
Control Interface	HANDLER, SINGAL
Communication Protocol	SCPI, Modbus RTU
Communication Interface	RS232C, LAN, RS485(Option)

10.2 Model and Function

Model	Output Power	ACW	DCW	IR	LAN Interface
UT5310A+	50VA	√	-	-	-
UT5310D+		√	√	-	-
UT5310R+		√	√	√	√
UT5320R+	100VA	√	√	√	√
UT5320R-S4A	100VA	√	√	√	√
UT5320R-S8A	100VA	√	√	√	√

(√ indicates the series has the function, - indicates the series doesn't have that function.)

10.3 Environmental Requirement

Environment	Index	Temperature 18°C~28°C Humidity ≤ 65% RH
	Operating	Temperature 10°C~40°C Humidity 10~80% RH
	Storage	Temperature 0°C~50°C Humidity 10~90% RH
Power Supply	100V-121V, 198V-242V, 47.5-63Hz	
Power Loss	UT5310x Series ≤300VA	
	UT5320x Series ≤400VA	
Size	280mm*88mm*428mm (UT5310A/D/R/20R+)	
	280mm*138mm*428mm (UT5320R-S4A/S8A)	
Weight of Instrument	UT5310A+/D+/R+	About 10.7kg
	UT5320R+	About 12.9kg
	UT5320R-S4A	About 16.27kg
	UT5320R-S8A	About 16.87kg
Gross Weight of Standard Package	UT5310A+/D+/R+	About 13.8kg
	UT5320R+	About 16.0kg
	UT5320R-S4A	About 20.12kg
	UT5320R-S8A	About 20.72kg

UNI-T[®]**UNI-TREND TECHNOLOGY (CHINA) CO., LTD.**

No.6, Gong Ye Bei 1st Road,
Songshan Lake National High-Tech Industrial
Development Zone, Dongguan City,
Guangdong Province, China

