

HADAS BUILT-IN CABINET INSTALLATION

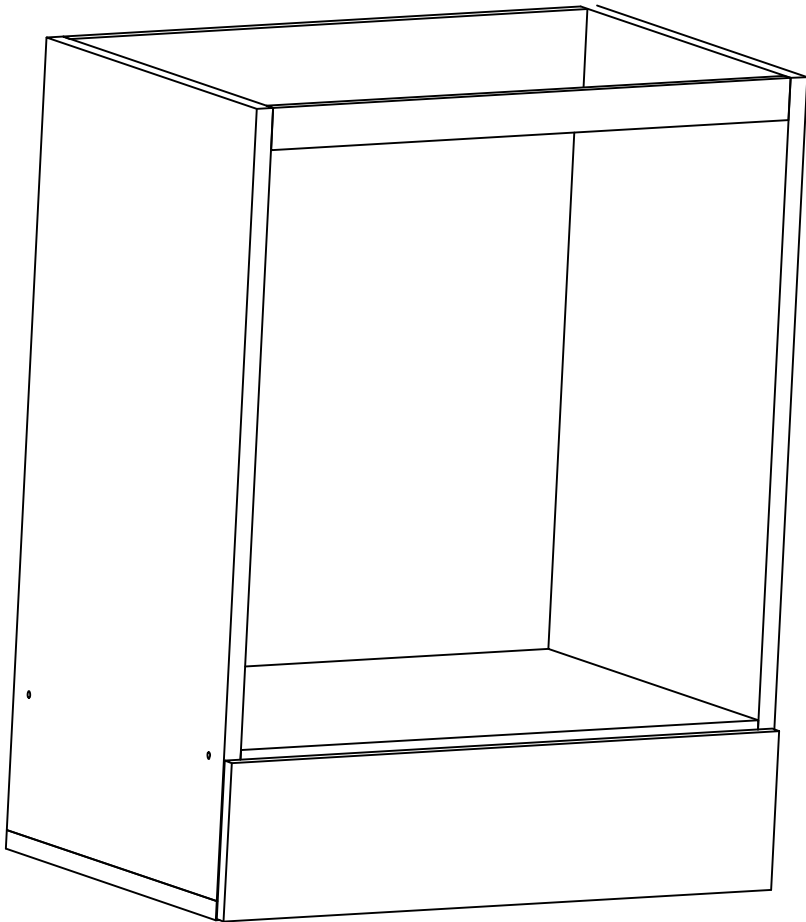

HADAS BUILT-IN CABINET INSTALLATION

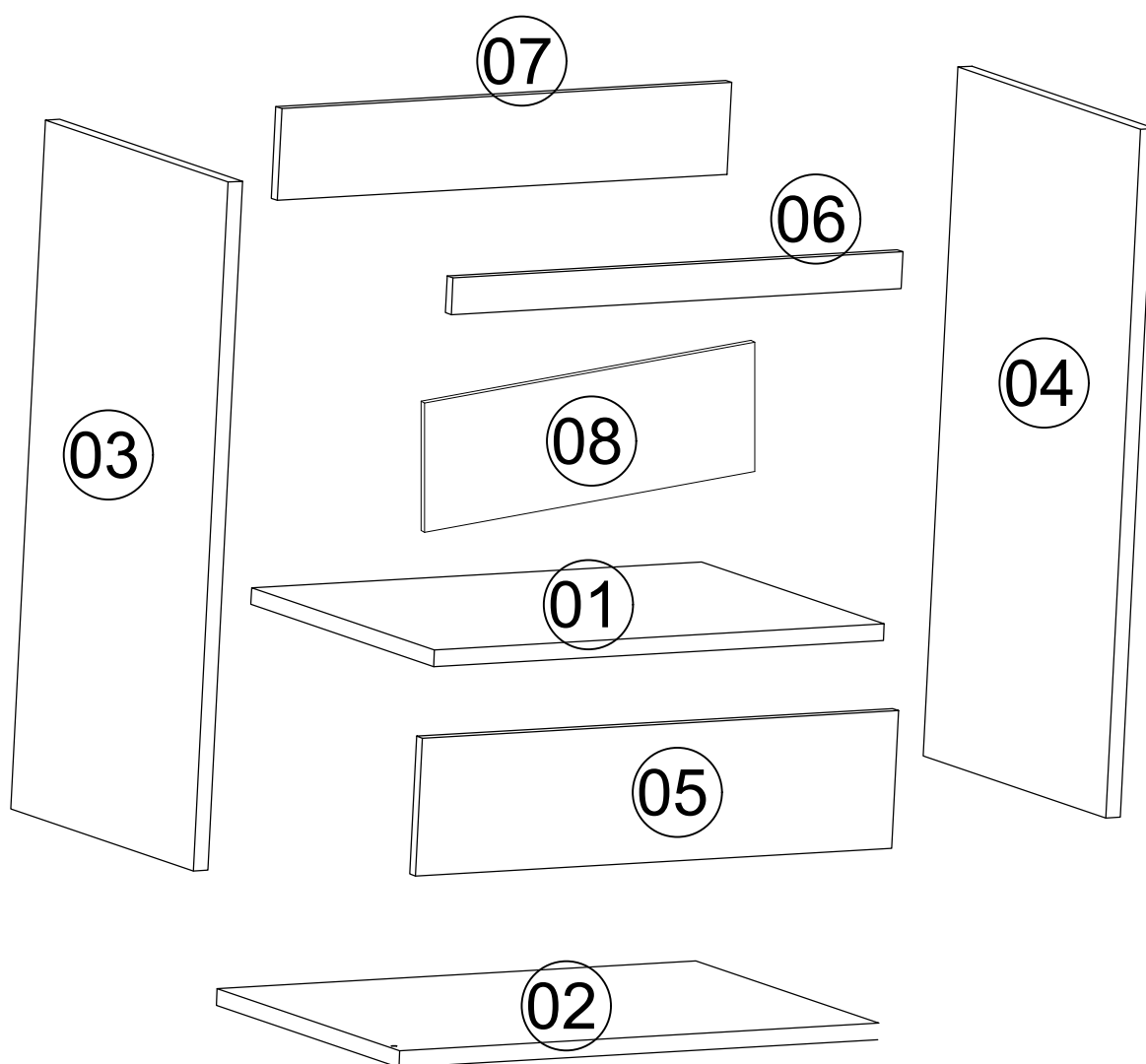



Dear Customer,

We design and produce our product for people to love and have fun with them as we do.
The product you bought was subjected to all sorts of tests and control before sending out to you.

Nos chers clients,

Tous nos produits ont été contrôlés et testés à chaque étape du processus de conception au processus de production et de livraison afin que vous puissiez profiter des produits et les utiliser pendant longtemps.

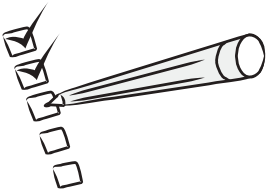

Before start assembling, please check the whole components and accessories according to the lists. If you bought more than one product, to prevent confusion be sure that you completed the first product. Then start the other product's assembling.

Avant de commencer l'installation, retirez toutes les pièces de la boîte et vérifiez selon les instructions de montage. Si vous avez acheté plusieurs produits, installez-les afin d'éviter de confondre pièces et accessoires.



Before start assembling, please clean all the components with a damp cloth. Also for usual cleaning, this will be enough.

Avant de commencer l'installation, nettoyez chaque pièce avec un chiffon humide. Dans l'utilisation générale du produit, ce nettoyage sera suffisant.

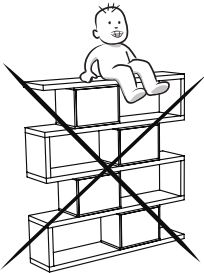

Do not use furniture for other purposes. If you would like to use it, please contact us for further questions.

Do not directly contact your furniture with excessive heat, cold and humidity because the product can be affected.

N'utilisez pas vos meubles à d'autres fins. Veuillez nous contacter lorsque vous envisagez une utilisation différente. Les meubles peuvent être endommagés par contact direct avec le froid, le chaud ou l'humidité. Pour cette raison, évitez tout contact direct de vos meubles avec ces facteurs.



WARNING

Serious or fatal crushing injuries can occur from furniture tip-over. To prevent this furniture from tipping over it must be permanently fixed to the wall with the included wall attachment devices.

Fixing devices for the wall are not included since different wall materials require different types of fixing devices. Use fixing devices suitable for the walls in your home. For advice on suitable fixing systems, contact your local specialized dealer.

AVERTISSEMENT

Des blessures mortelles ou graves peuvent résulter du basculement de vos meubles. Pour éviter tout risque de renversement, vos meubles doivent être fixés au mur avec l'appareil inclus dans le produit. Étant donné que les matériaux de construction des murs peuvent être différents, les accessoires nécessaires pour fixer les meubles au mur ne sont pas inclus dans le produit. Choisissez des raccords adaptés au matériau de construction mural de votre maison. Sélectionnez des raccords adaptés à vos matériaux de construction de murs. Vous pouvez obtenir des informations du marché du bâtiment le plus proche ou d'une quincaillerie pour acheter des raccords adaptés à votre matériau de construction mural.



Liebe Kunden,

alle unsere Produkte werden von der Designphase bis zur Produktions- und Auslieferungsphase sorgfältig überprüft und getestet, sodass sie jahrelang haltbar bleiben.

Gentile Cliente,

questo prodotto è stato ideato e realizzato con attenzione per il design, sottoponendolo a tutti i tipi di test e controlli prima di essere messo in vendita.



Vor dem Aufbau nehmen Sie bitte alle Teile aus der Packung raus und kontrollieren Sie sie anhand des Montagehandbuchs, ob sie vollständig sind. Falls Sie mehr als ein Produkt gekauft haben sollten, achten Sie bitte darauf, dass die Teile nicht ineinander überlaufen. Deswegen ist es wichtig, dass ein Produkt nach dem anderen aufgebaut wird.

Verificare l'idoneità della parete prima di procedere al fissaggio. Prima dell'assemblaggio controllare che tutti i componenti ed accessori siano presenti come indicato nella lista accessori.



Bitte wischen Sie vor dem Aufbau jedes Teil mit einem feuchten Tuch ab.

Prima dell'assemblaggio pulire tutti i componenti con un panno umido. Questa procedura dovrà essere eseguita ogni qualvolta si vorrà pulire il prodotto.

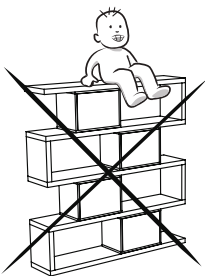

Bitte benutzen Sie Ihr Möbel nicht außer dem Verwendungszweck. Im Falle einer Verwendungszweckänderung kontaktieren Sie bitte zuerst uns. Die Möbel können beschädigt werden, wenn sie zu hohen oder zu niedrigen Temperaturen sowie Feuchtigkeit ausgesetzt werden. Bitte vermeiden Sie diese Fälle.

Non utilizzare il prodotto per altri usi.

Non mettere in contatto questo prodotto con fonti di calore, freddo ed umidità perché si potrebbe danneggiare.



SICHERHEITSHINWEIS

Durch Umkippen der Möbel können lebensgefährliche Situationen auftreten. Die Umkipf-Gefahr zu verhindern, sollte Ihr Möbel mit dem beigelegten Apparat an die Wand befestigt werden. Da die Wandbaustoffe variieren, wurde ein Wandmontageset nicht mitgeliefert. Bitte informieren Sie sich über Ihren Wandbaustoff und besorgen Sie das entsprechende Wandmontageset, das Sie bei einem Heimwerkermarkt finden können.

AVVERTENZA

Se il mobile si ribalta può causare lesioni da compressione serie o fatali. Per prevenire il rischio che il mobile si ribalti, quest'ultimo deve essere fissato permanentemente alla parete.



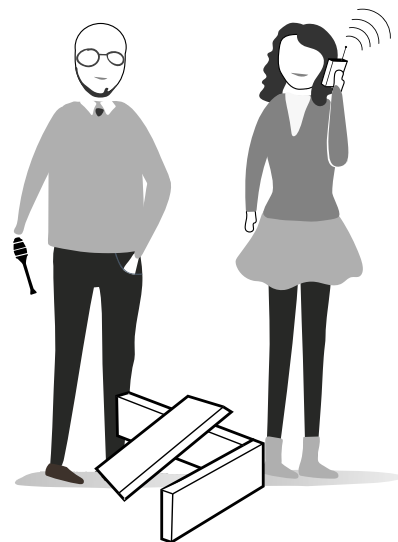
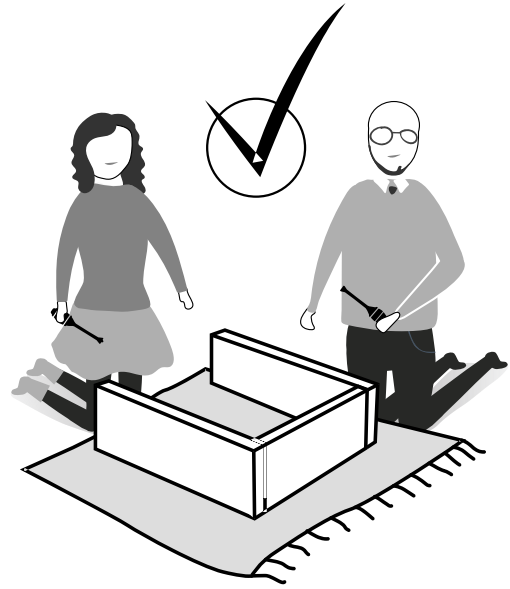
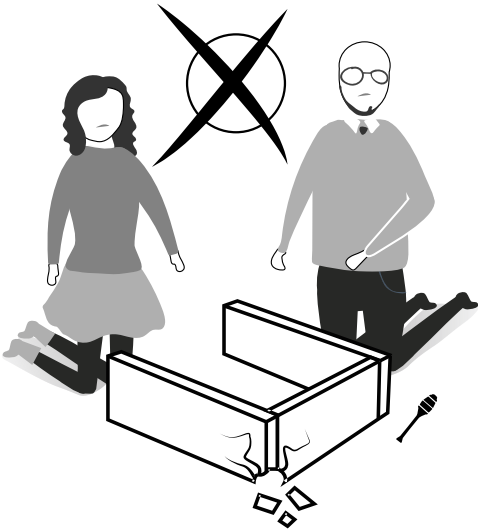
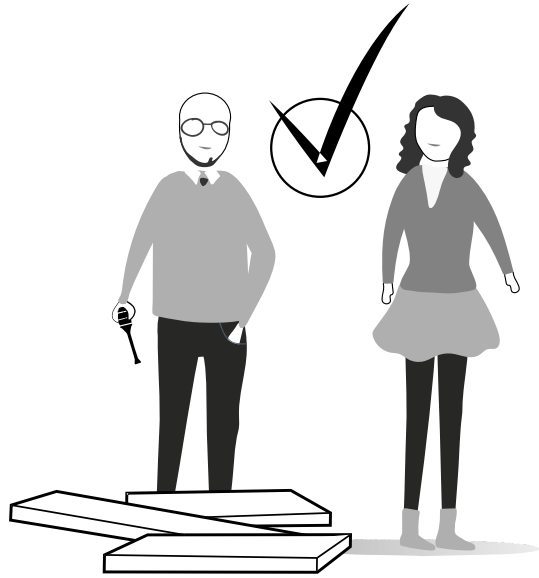
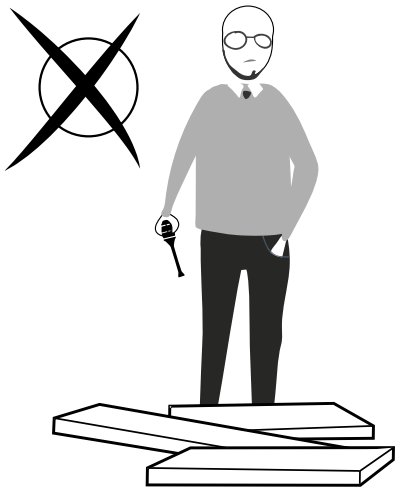



Gli accessori per il fissaggio alla parete non sono inclusi perché pareti di materiali diversi richiedono tipi diversi di accessori di fissaggio. Usa sistemi di fissaggio adatti alle pareti della tua casa. Per maggiori dettagli, rivolgiti a un rivenditore specializzato.

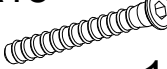

ACCESSORY LIST

Follow the installation steps in the order as shown.
Position the parts as shown in the installation guide steps.

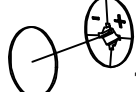
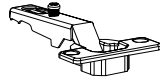

<p>A01 3,5x18 screw 08x</p> 	<p>A22 Dowel 02x</p> 	<p>A18 Confirmat 14x</p> 	<p>A02 Ayan 01x</p> 	<p>A15 screw cover 14x</p> 
<p>A07 Hinge 02x</p> 	<p>A13 Hinge base 02x</p> 	<p>A17 nail 20x</p> 		

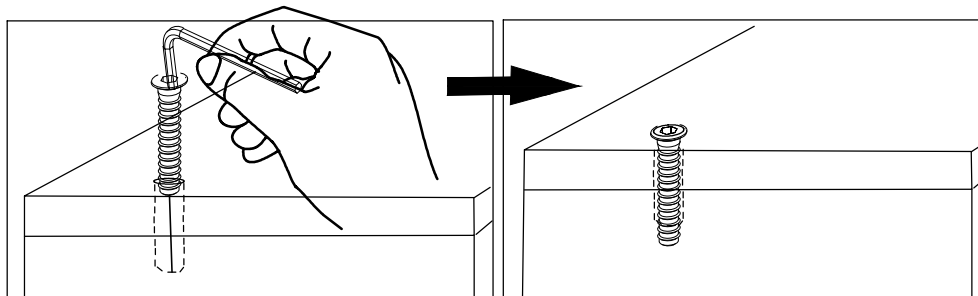
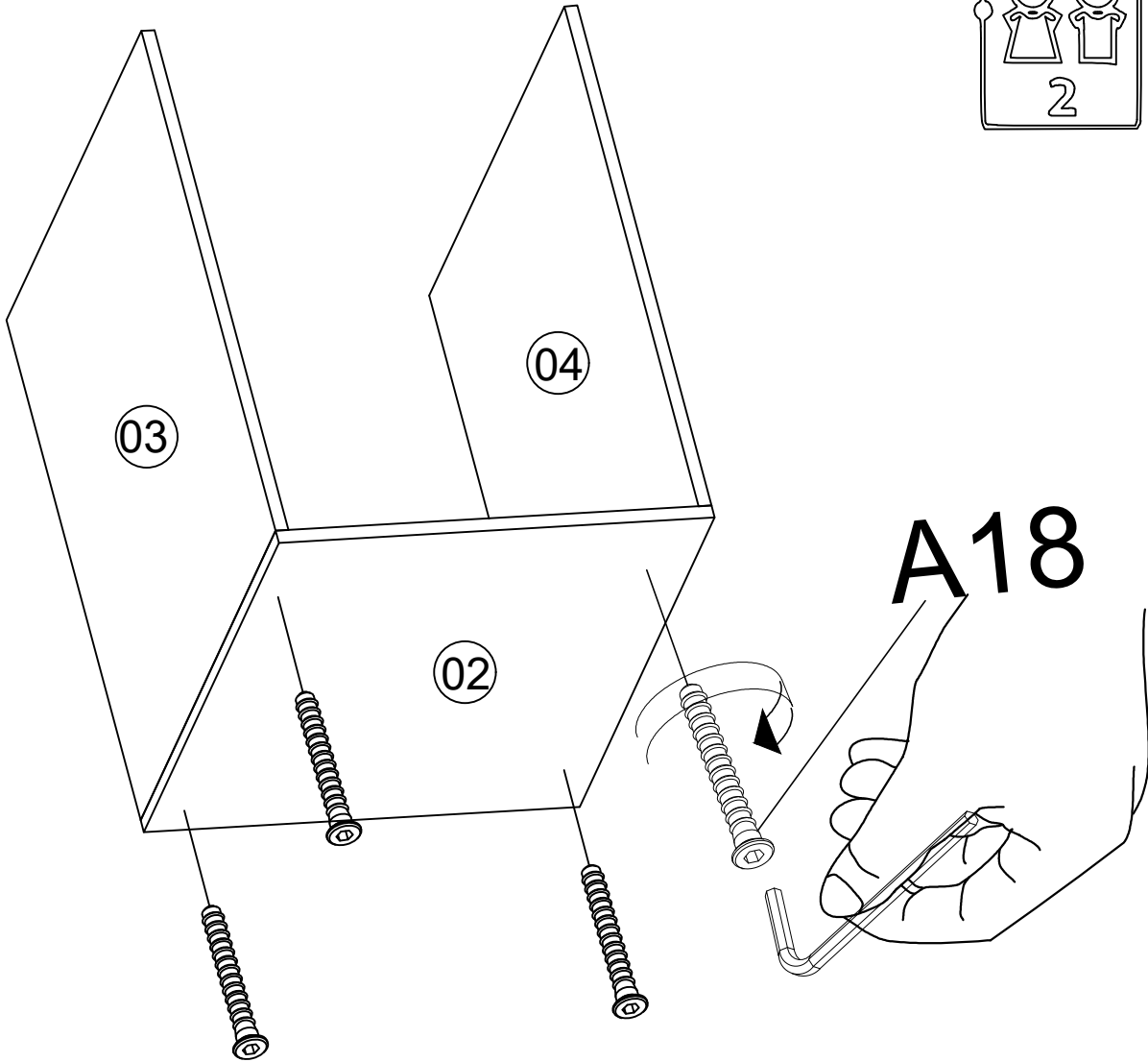
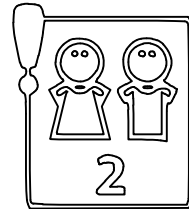

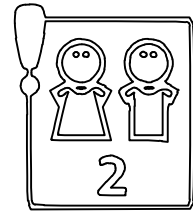

A18

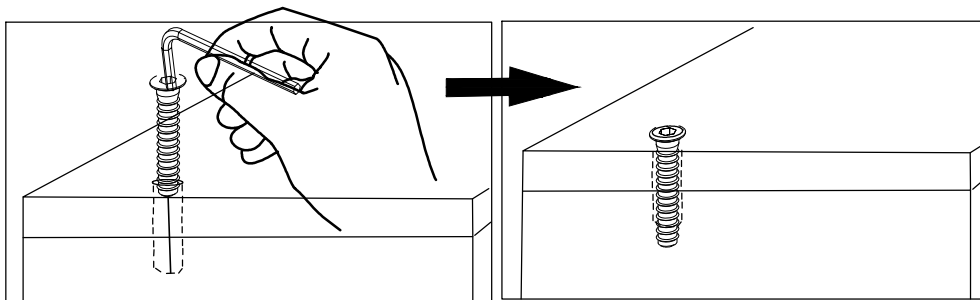
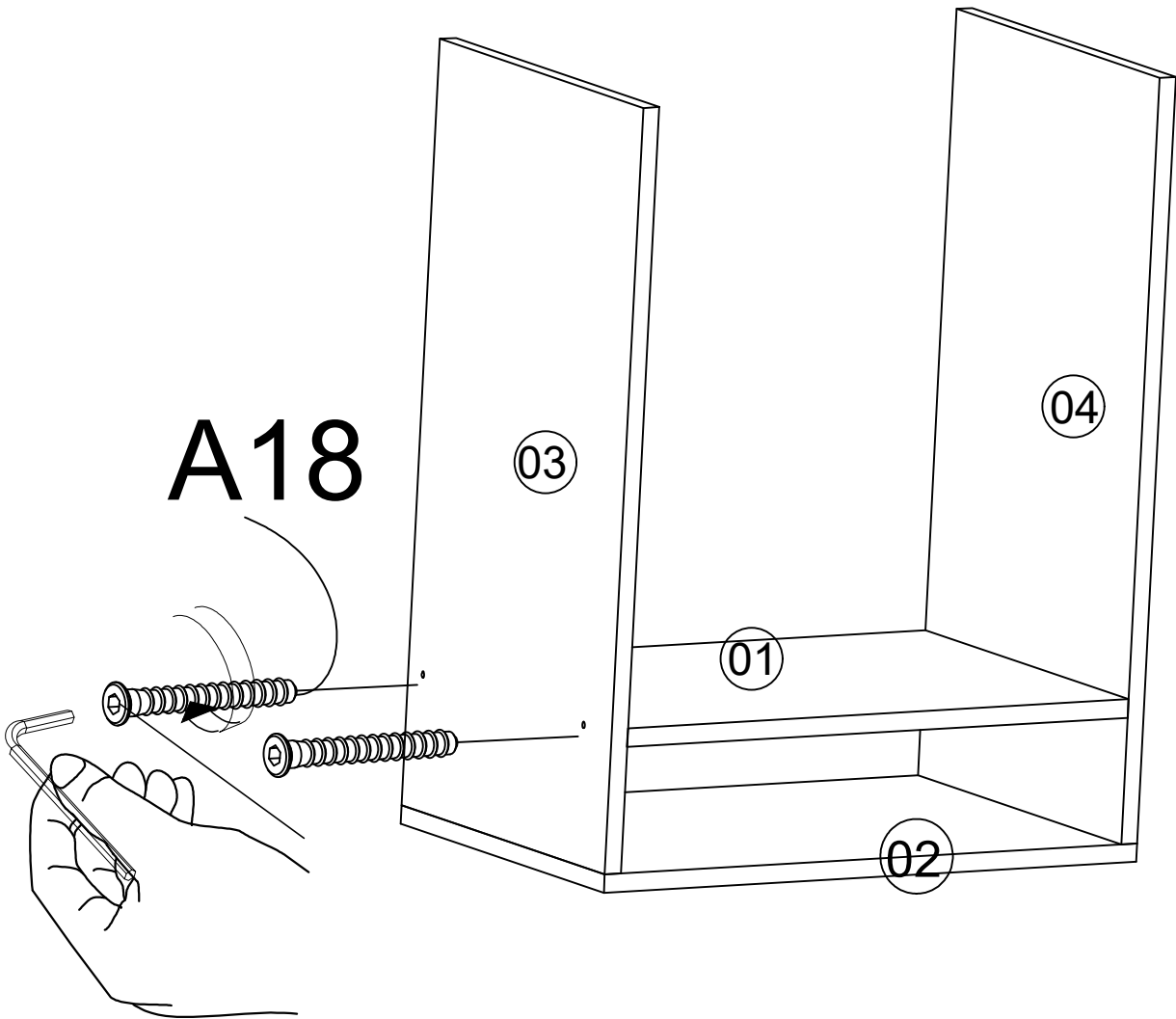

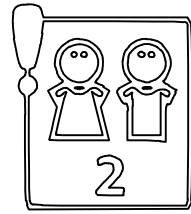

A18

