

ÜRÜN ADI : LİNE GENÇ ODASI

MODÜL ADI : MASA ALT MODÜL

ÜRÜTİM YILI : 2023

DÖK. NO :

FR-117

YAY. TARİHİ :







*

REV / NO TARİH :

00/00/2023

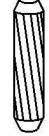
SAYFA:1

AKSESUAR POŞETİ

A		MİNİFIX GÖVDE	31 Adet	B		MİNİFIX MİL Ø7 x 34	31 Adet	C		PL5 KAVAL Ø8 x 30	28 Adet
WY		3,5 X 18 SUNTA VİDASI	8 Adet	CL		40 LİK TELESKOPIK RAY	1 Takım	VT		M4 X 22 KULP VİDASI	2 Adet
DB		DÜZENLEYİCİ	1 Adet								

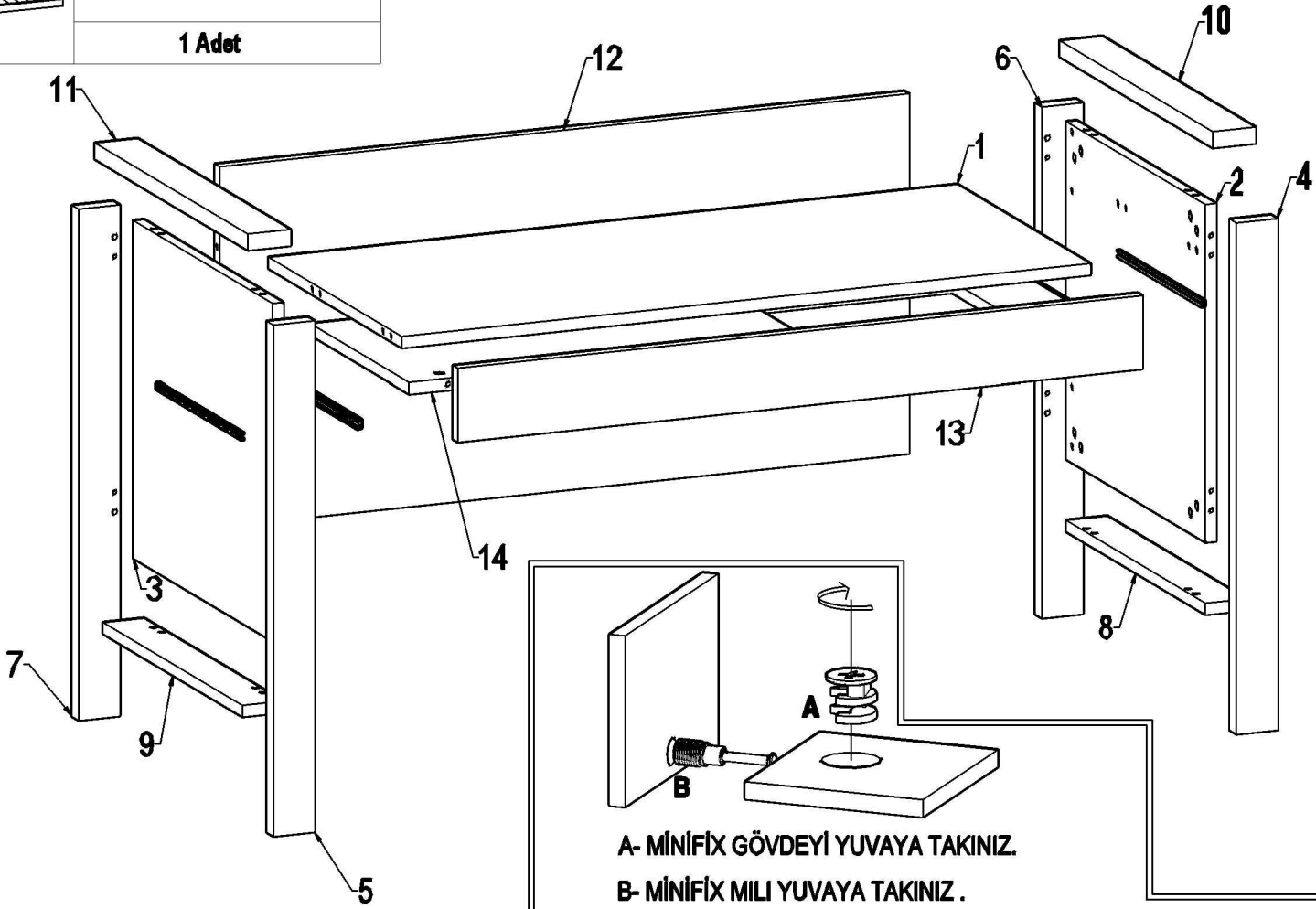

A- MİNİFIX GÖVDEYİ YUVAYA TAKINIZ.

B- MİNİFIX MİLİ YUVAYA TAKINIZ .

- MİNİFIX GÖVDEYİ TORNAVİDA YARDIMI İLE 185 DERECE ÇEVİRİNİZ.

NO	PARÇA ADI	ADET	NO	PARÇA ADI	ADET
01	MASA ÜST TABLA	1	08	MASA SAĞ ALT KLAPA	1
02	MASA SAĞ YAN TABLA	1	09	MASA SOL ALT KLAPA	1
03	MASA SOL YAN TABLA	1	10	MASA SAĞ ÜST KLAPA	1
04	MASA SAĞ ÖN KLAPA	1	11	MASA SOL ÜST KLAPA	1
05	MASA SOL ÖN KLAPA	1	12	MASA ARKA PANO	1
06	MASA SAĞ ARKA KLAPA	2	13	MASA ÇEKMECE ÖNÜ	1
07	MASA SOL ARKA KLAPA	2	14	MASA ÇEKMECE ALTI	1

DİKKAT  MONTAJ SIRASINDA ŞARJLI TORNAVİDA VEYA EL MATKABI KULLANMAYINIZ..