

LİNDİ TV ÜNİTESİ

MONTAJ VE KULLANIM KLAVUZU ASSEMBLY MANUEL

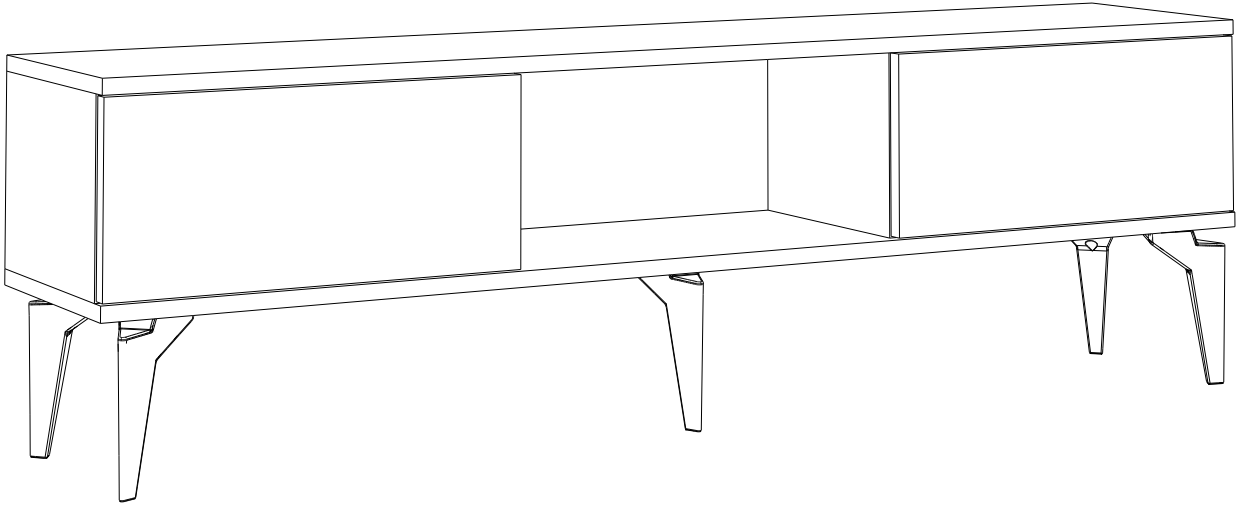





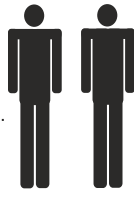



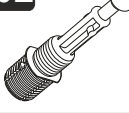

SAYFA 2

Bu modül iki kişi tarafından kurulmalıdır.
This unit should be assembled by two persons.

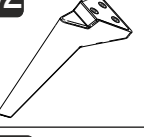

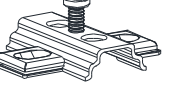
AKSESUAR LİSTESİ / Accessory List

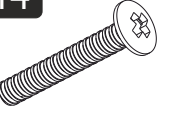
Bu modülün kurulumu için gerekli olan araçlar.
The necessary tools (not included)

A01 Minifix Gövde  16x	A02 Minifix Mil  16x	A04 Minifix Tapa  16x	A10 3,5x18 YHB Vida  16x	A28 Arkalık Çivisi  30x
A52 Elegans ayak  5x	A11 Tam Deve Boynu Menteşe  4x	A13 Minifix Atlığı  4x	A41 Üçgen kulp (siyah)  2x	A14 M4x22 Kulp Vidası  2x
A20 3,5x30 YHB vida  20x				

PARÇA KODLAMA / GENERAL VIEW

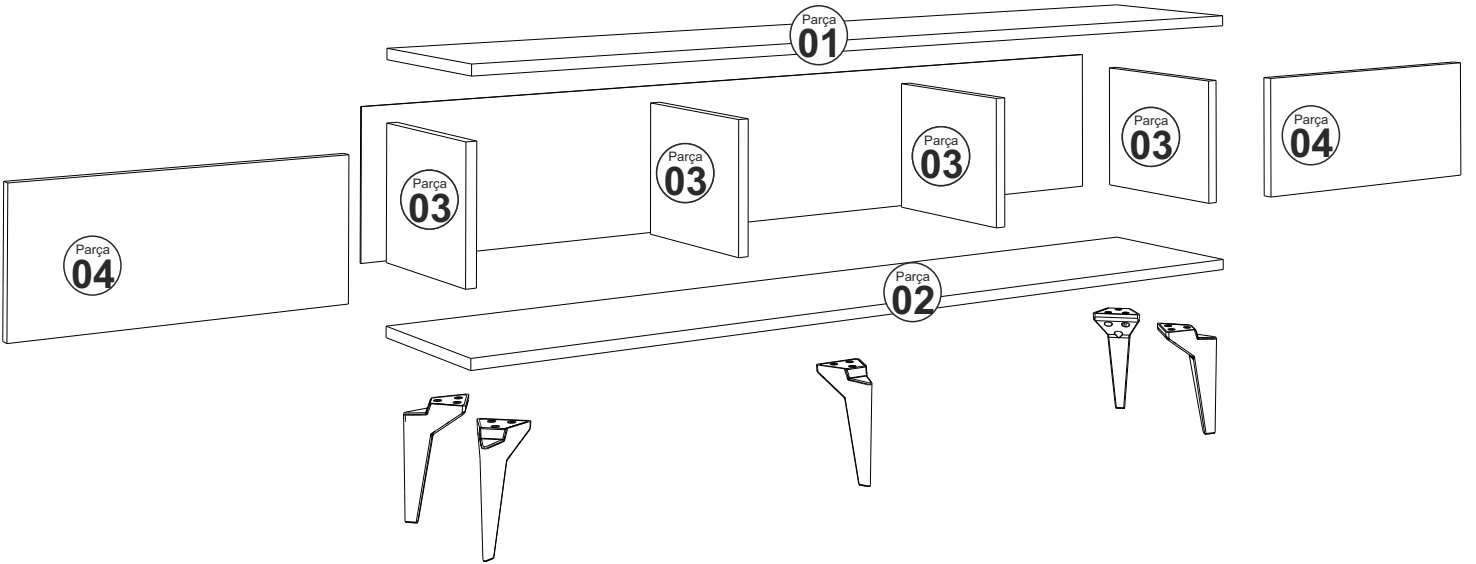

SAYFA 3

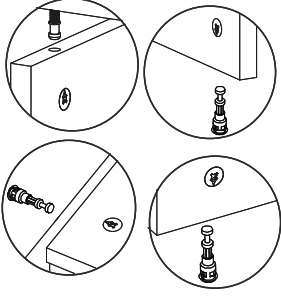

A02

Minifix Mil

A01

Minifix Gövde

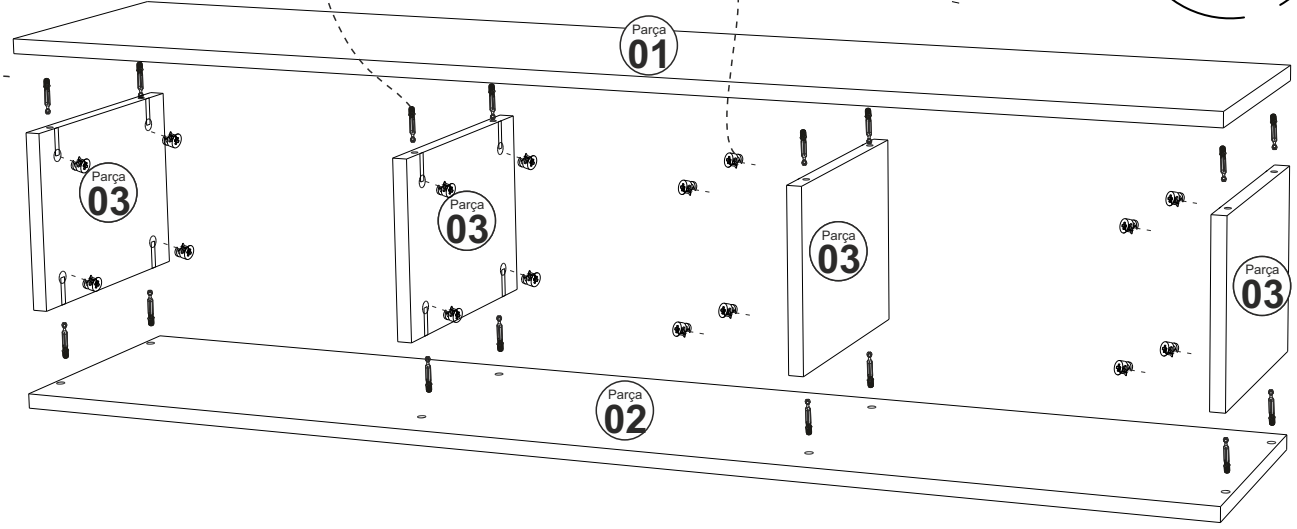

A28

Arkalık Çivisi

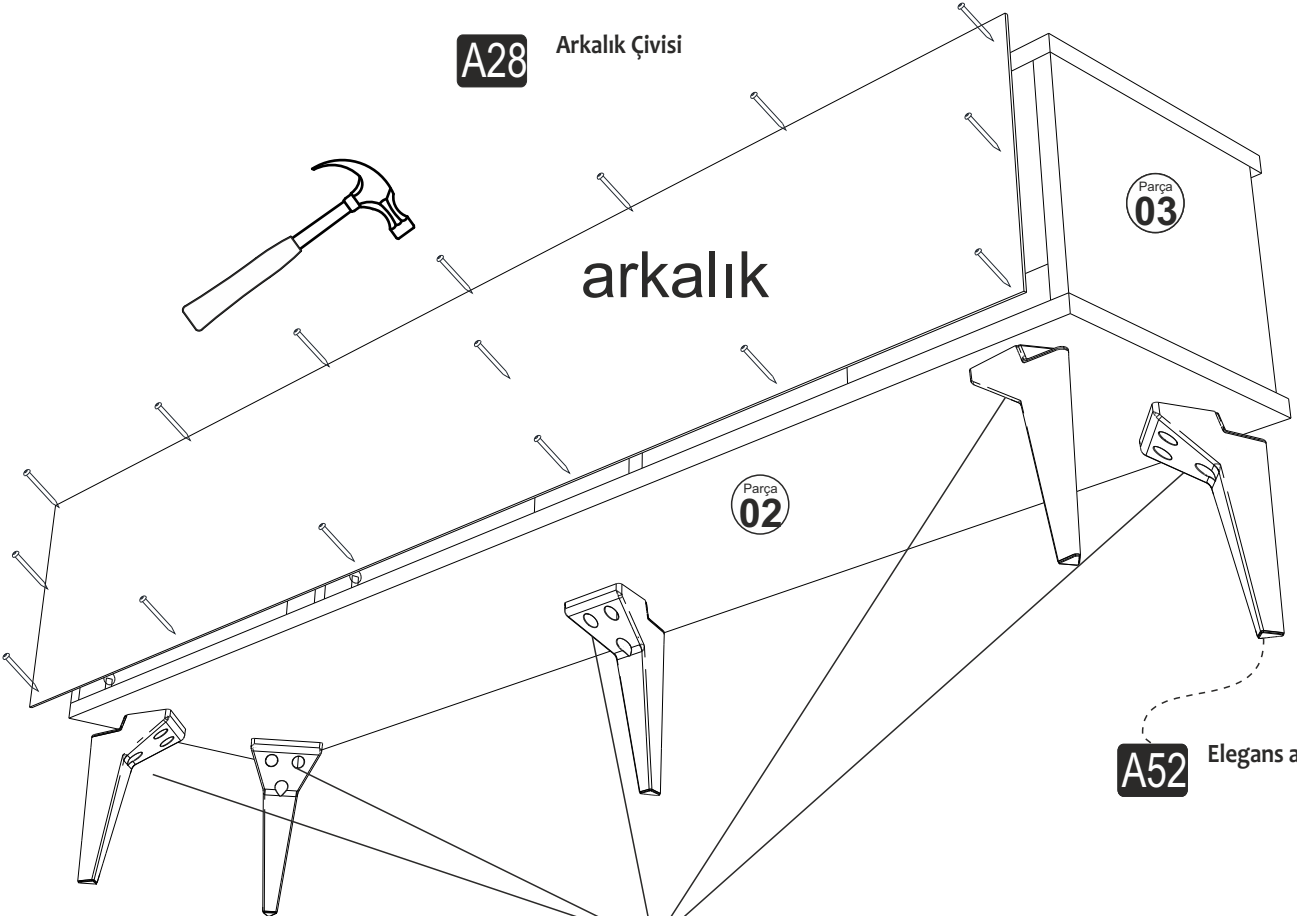

A52

Elegans ayak

A20

3,5x25 YHB vida

