

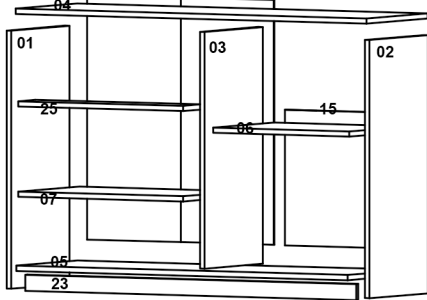

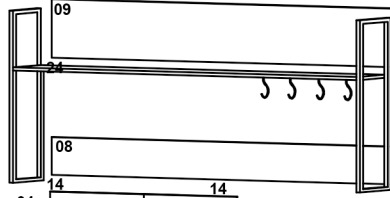

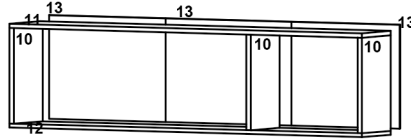

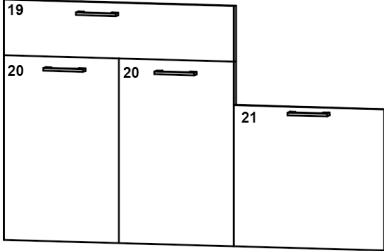

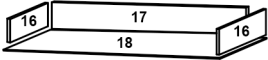
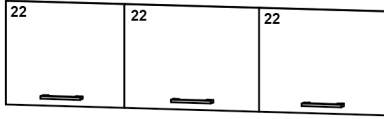



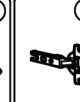





AVMPARK

ERVİN KAHVE KÖŞESİ 3 KAPAKLI

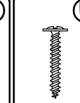

 Minifix 42 Adet	 Minifix karşılığı 42 Adet	 Kavela 1 Adet	 Y.Deve Mentеше 2 Adet	 Düz Mentеше 10 Adet	 Mentеше karşılığı 12 Adet
 Kulp vidası 14 Adet	 3,5x18 Vida 56 Adet	 3,5x40 Vida 3 Adet	 Raf pimi 4 Adet	 Ray 1 Takım	 Civi 60 Adet
 4x60 Siyah Vida 8 Adet	 Kulp 7 Adet	 Askı 4 Adet	 Çivili Pabuç 6 Adet	 3,5x25 M.Vida 6 Adet	 4x20 Vida 4 Adet

PARÇA ÖLÇÜLERİ

01- 832x400x18	10- 314x200x18	19- 194x826x18
02- 832x400x18	11- 1350x200x18	20- 569x412x18
03- 754x400x18	12- 1350x200x18	21- 467x516x18
04- 1350x420x18	13- 347x446x3	22- 347x446x18
05- 1312x400x18	14- 787x410x3	23- 1312x60x18
06- 500x400x18	15- 466x524x3	24- 1310x200x18
07- 794x400x18	16- 350x140x18	25- 794x100x18
08- 1310x100x18	17- 732x124x18	
09- 1310x180x18	18- 752x360x3	

Satın almış olduğunuz ürün AVMPARK tarafından parça garantisi kapsamındadır. Kargo kaynaklı hasarlar durumunda, 0507 109 94 21 nolu telefona whatsapp uygulaması üzerinden hasarlı parçanın görseli ve sipariş bilgilerinizi iletmeniz durumunda ücretsiz parça gönderimi yapılmaktadır.

1

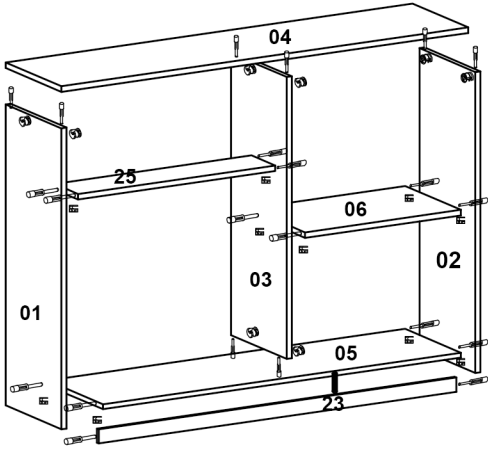
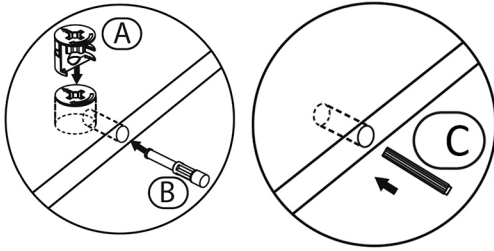

*Dolabı yatay zeminde montalayınız. (Dik konumda kurulumu başlamayınız.)
*İşaretili olan bölgelere minifix ve kavela takımlarını yerleştiriniz ve tornavida yardımı ile sıkıştırınız.

2

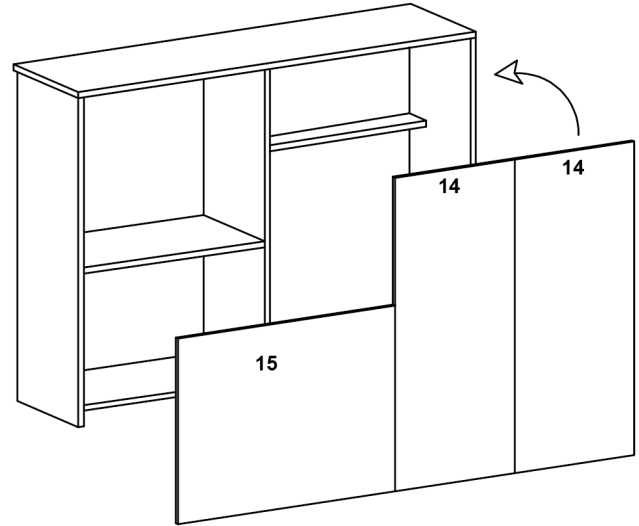
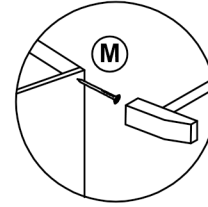

*14 ve 15 numaralı arkalıkları dolaba çivi ile sabitleyiniz.

3

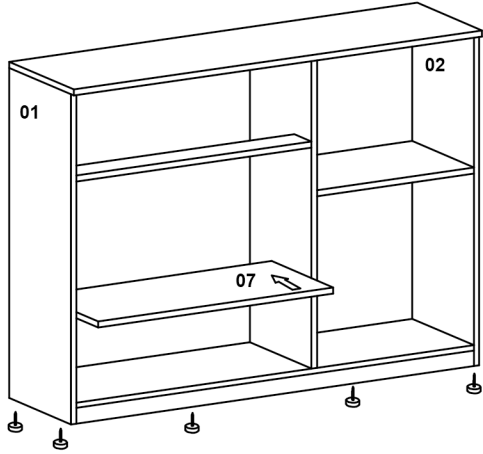
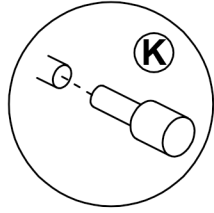

*07 numaralı rafı raf pimlerinin üzerine yerleştiriniz.
*Çivili pabuçları 01 ve 02 numaralı parçalara çakınız.

4

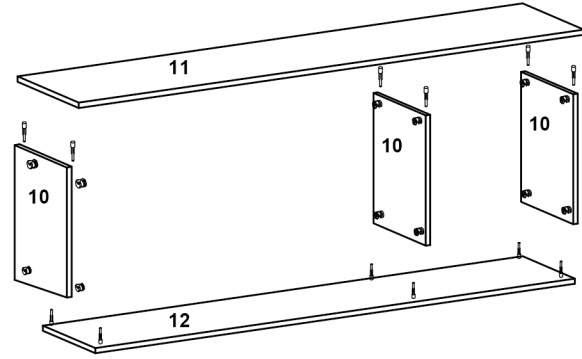
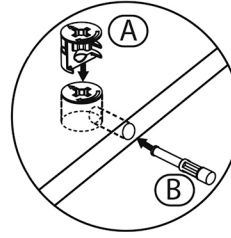

*İşaretti olan bölgelere minifix takımlarını yerleştiriniz ve tornavida yardımı ile sıkıştırınız.

5

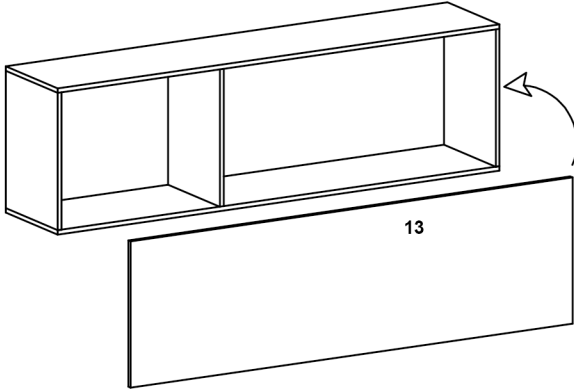
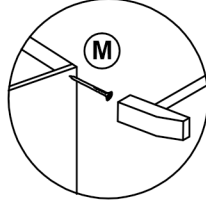

*07 numaralı rafı raf pimlerinin üzerine yerleştiriniz.
*Çivili pabuçları 01 ve 02 numaralı parçalara çakınız.

6

*Bardak askılarını rafa
4x20 vida ile monte ediniz.

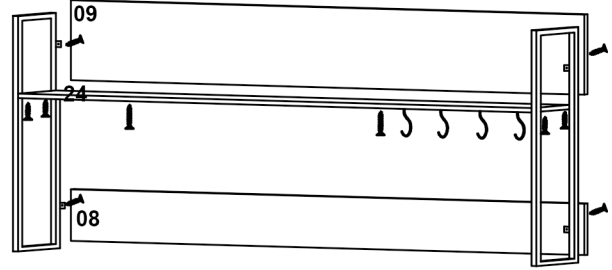
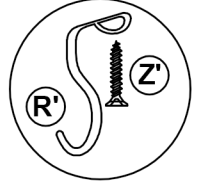

*08, 09 ve 24 numaralı parçaları metallere 3,5x18 vida ile monte ediniz.
*09 numaralı arka tablanın alt kısmından 3,5x40 vida ile sabitleme yapınız.

7

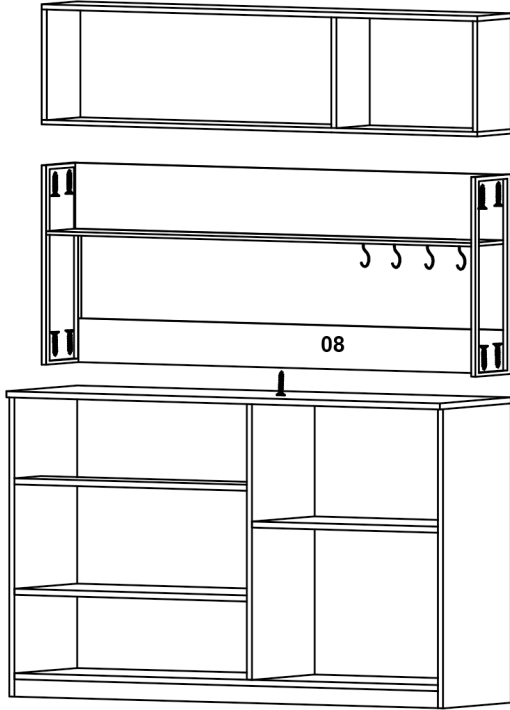

*Kırmış olduğunuz 3 modül metalardan
4x60 siyah vida ile monte ediniz.

*08 numaralı arka tablanın alt kısmından
3,5x40 vida ile sabitleme yapınız.

8

*İşaretleli olan bölgelere kavela ve minifix takımlarını yerleştiriniz
ve tornavida yardımı ile sıkıştırınız.

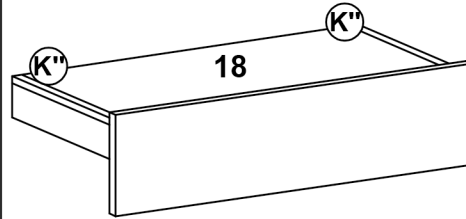
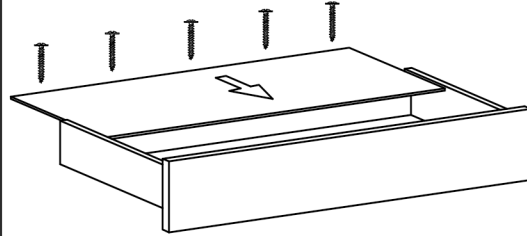
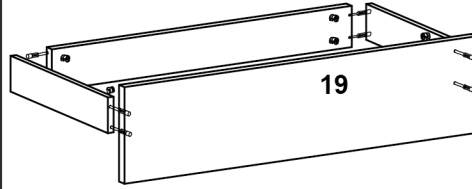

*Rayları çekmece yanlarına 3,5x18 ile monte ediniz.

9

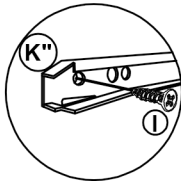
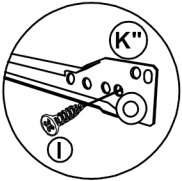
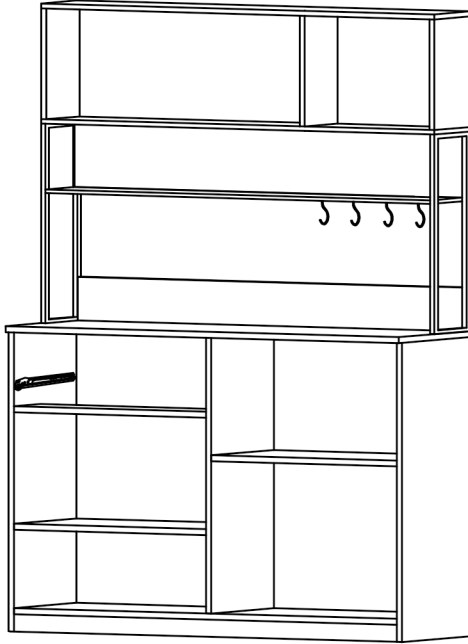

*Rayları dolap gövdesine 3,5x18 vida ile monte ediniz.

10

!!! Üst orta kapağa yarım deve menteşe (D) kullanınız.

