

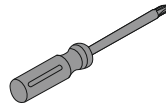

PRODUCT NAME	SPORT BOOKCASE
MODEL NUMBER	CHIPBOARD, PLASTIC

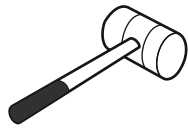

ASSEMBLY INSTRUCTIONS

PAGE: 6/1

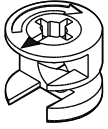
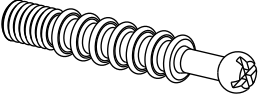
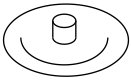
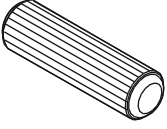
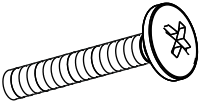
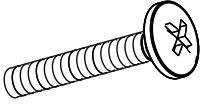
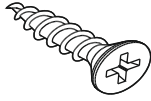
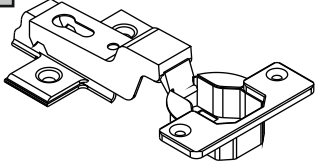
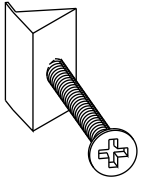
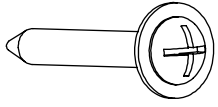

A 	B 	C 	D 
MINIFIX NUT x31 pc.	MINIFIX STUD x31 pc.	MINIFIX WHITE PLUG x31 pc.	DOWEL x30 pc.
E 	F 	G 	H 
YSB SCREWS M6x30 x8 pc.	YSB SCREWS M4x25 x2 pc.	3.5x18 BACKREST SCREW x28 pc.	CAMEL HINGE x4 pc.
I 	K 	L 	
CORNER PLASTIC x12 pc.	3x25 BACK SCREW x4 pc.	HANDLE x2 pc.	

1

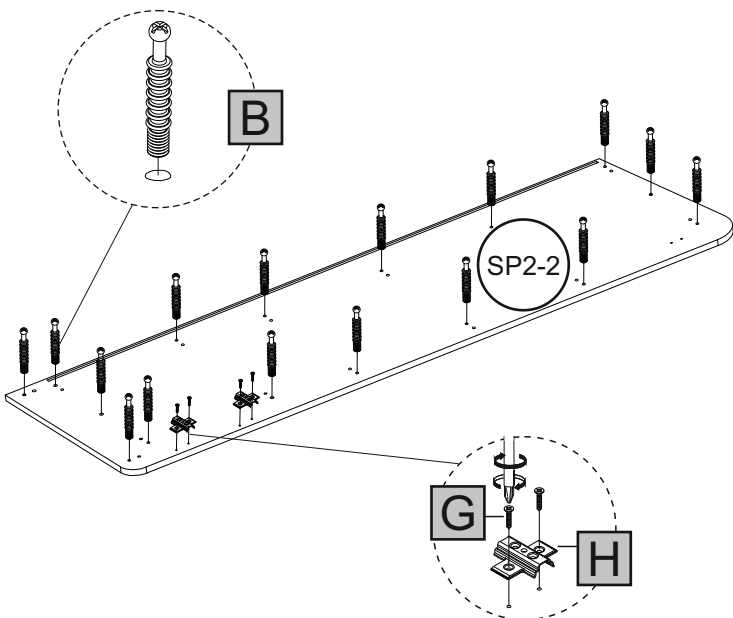

2

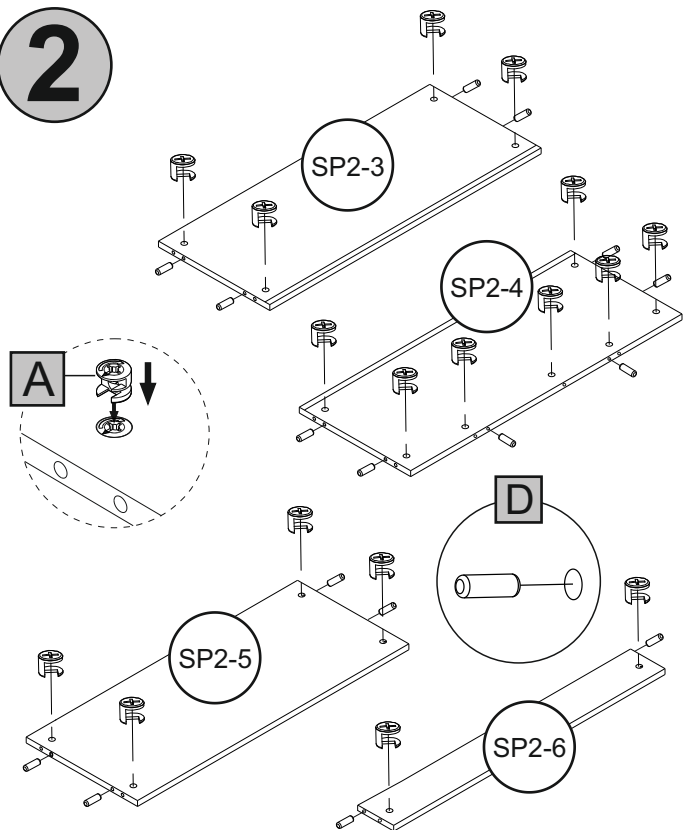

3

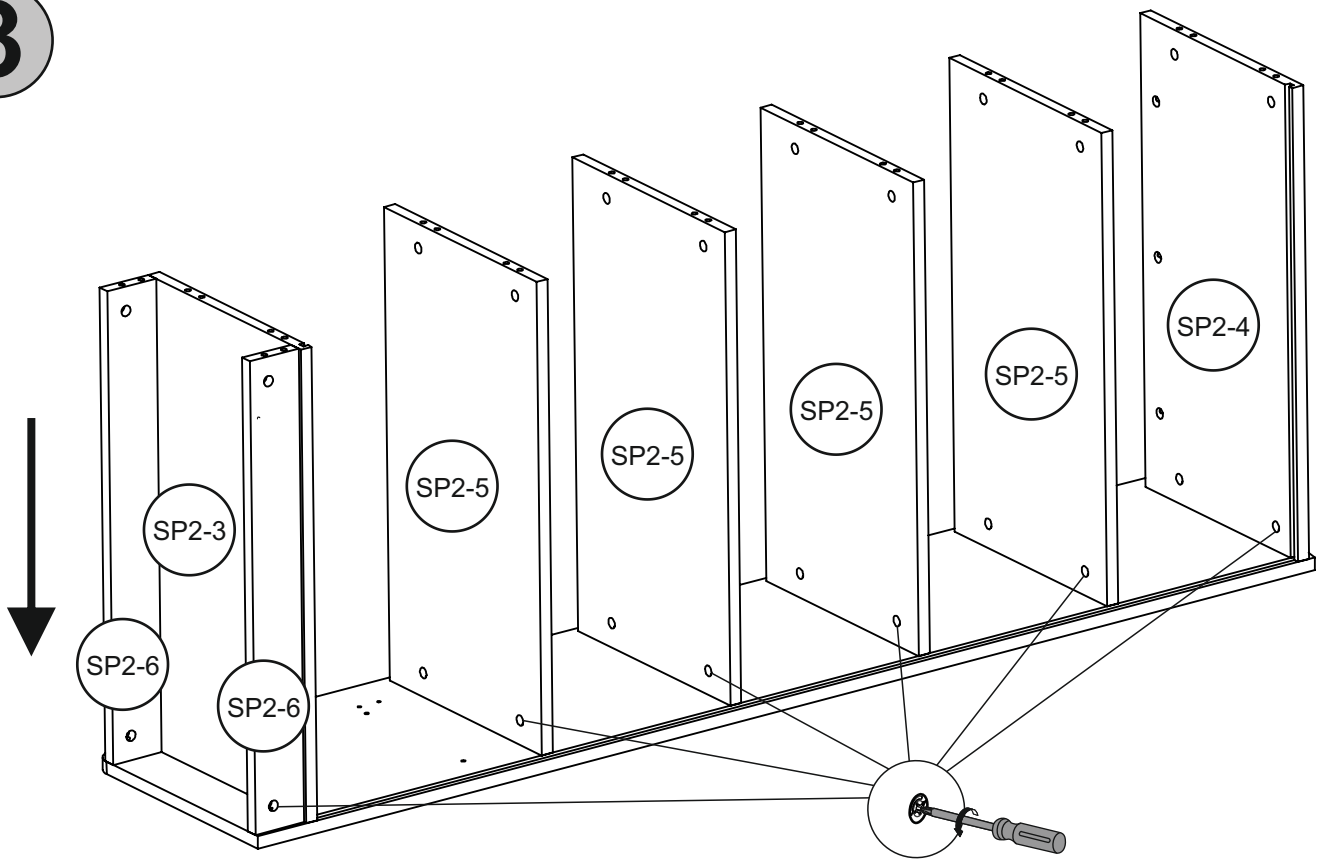

4

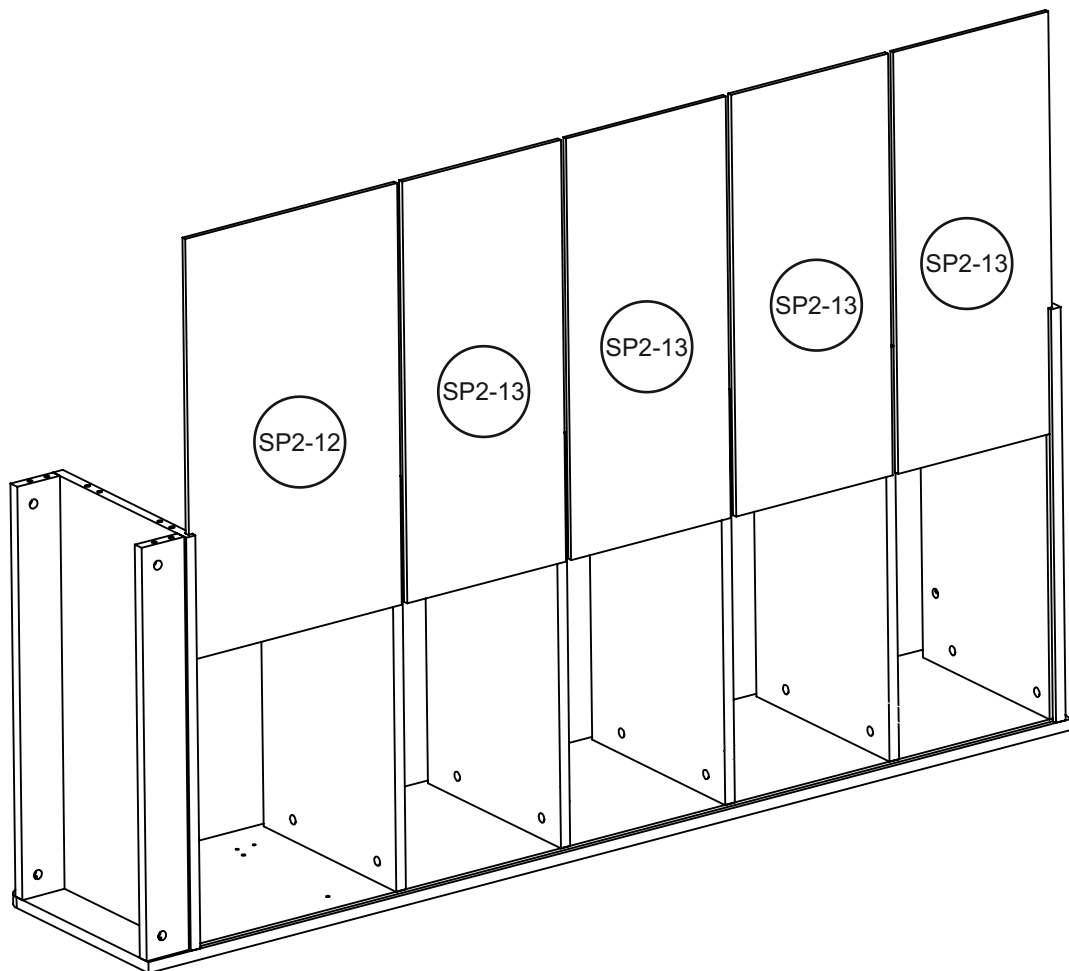

5

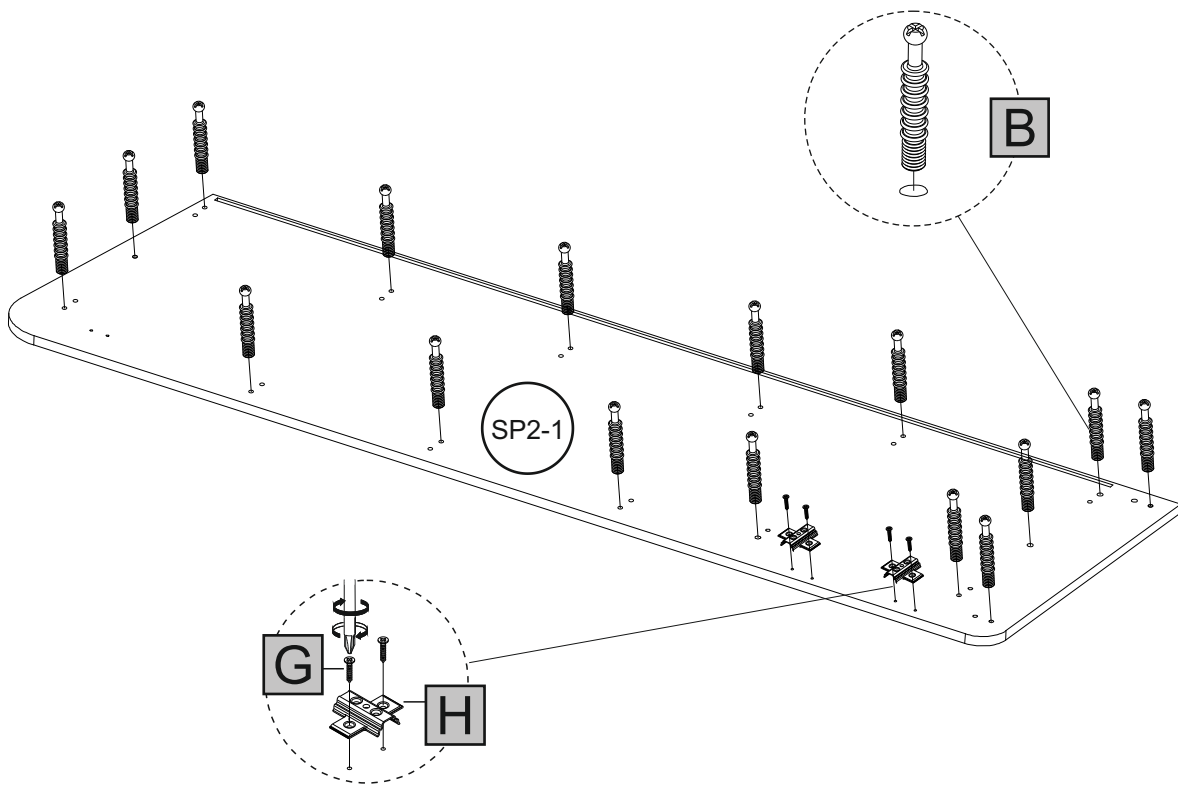

6

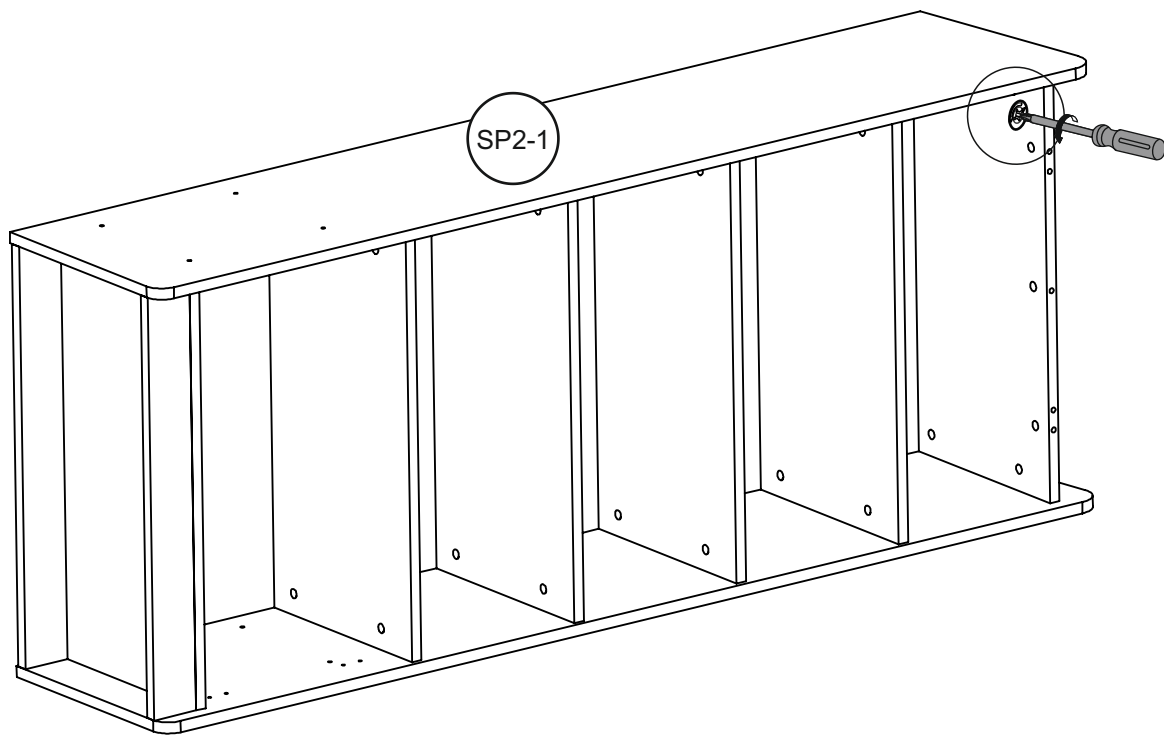

7

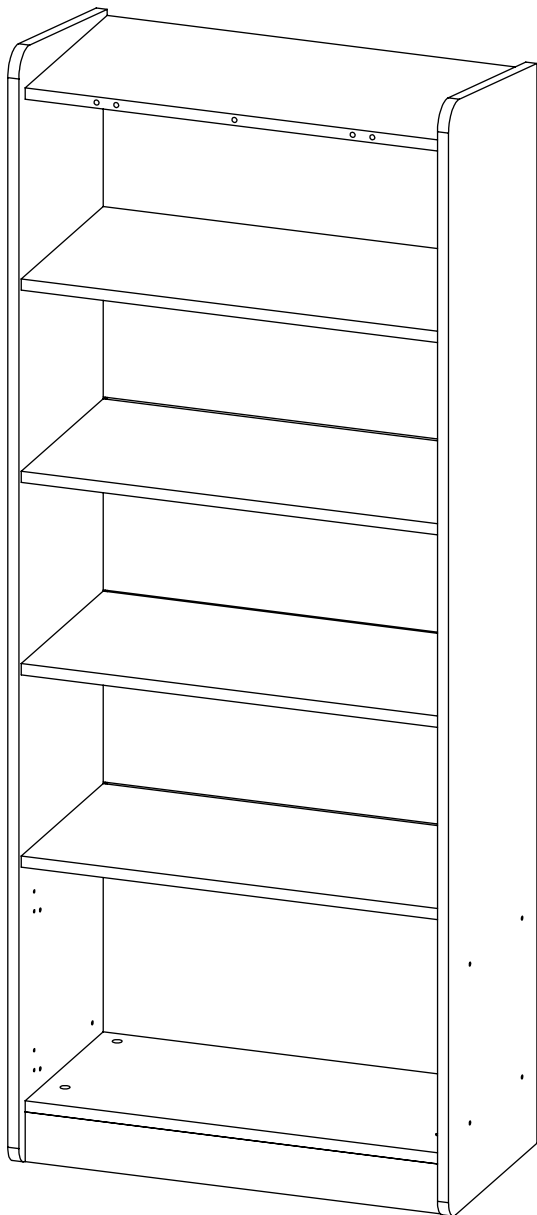
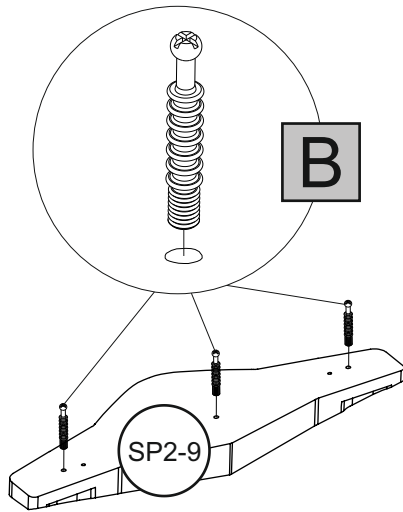

8

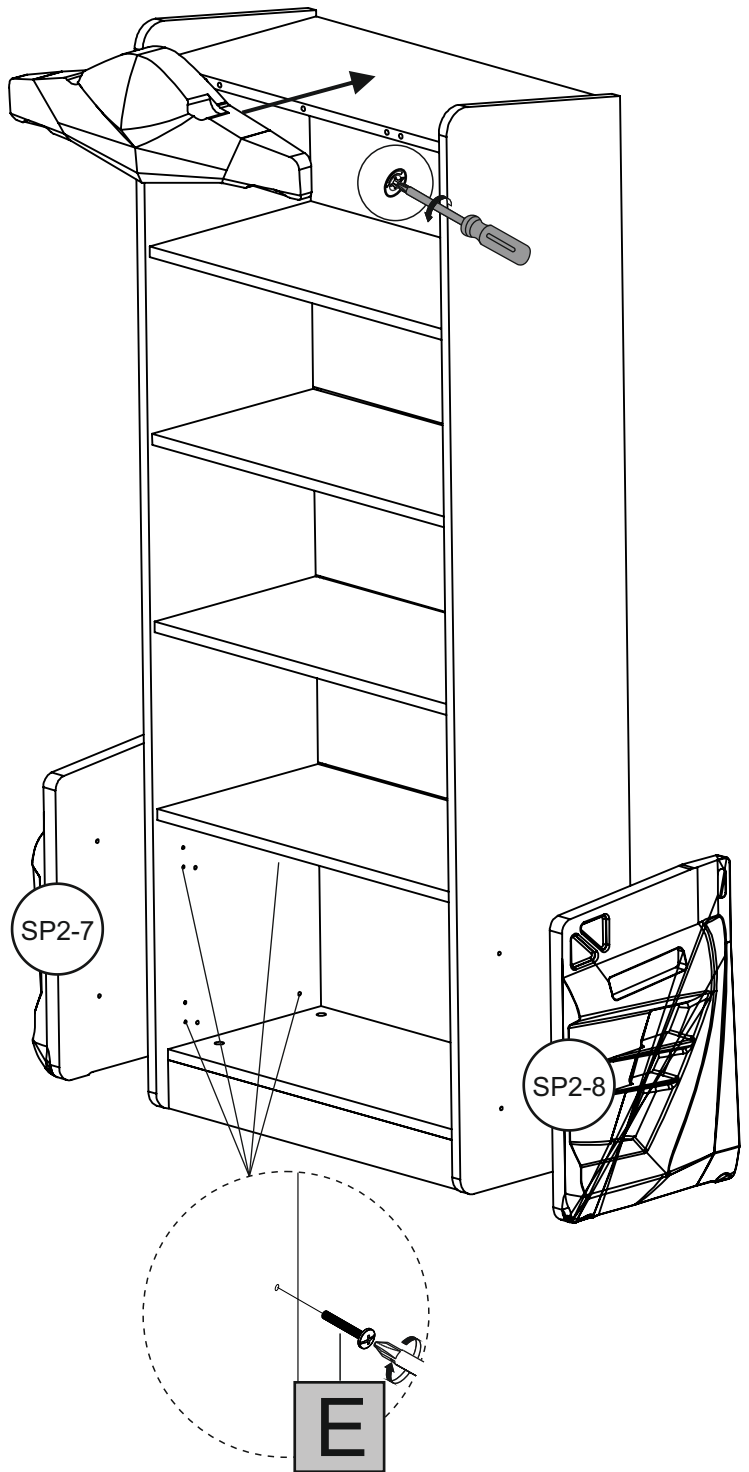

9

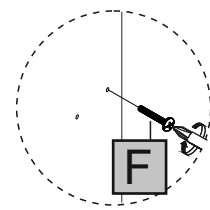
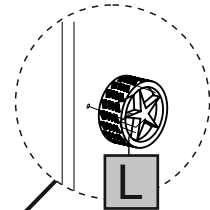
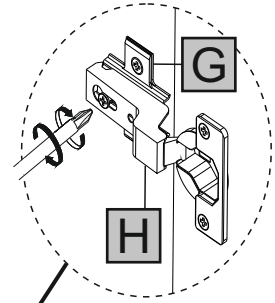
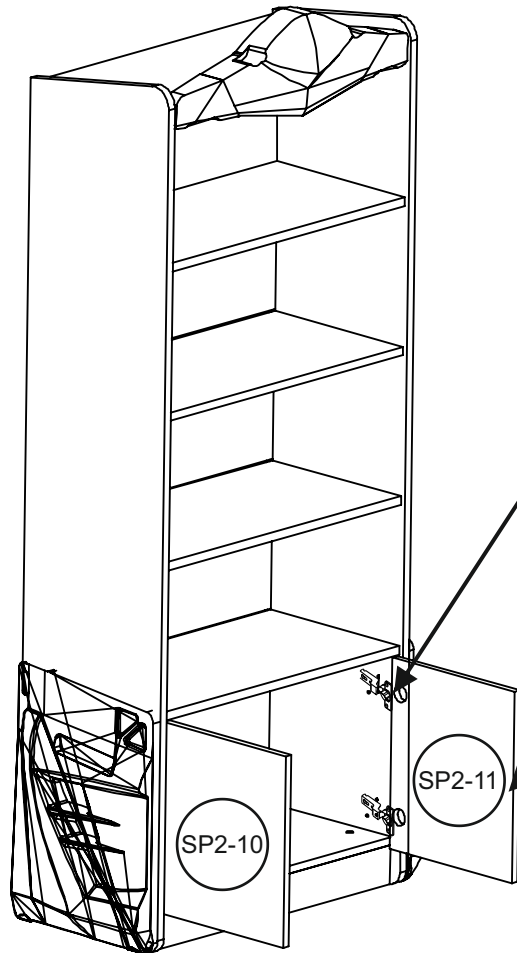
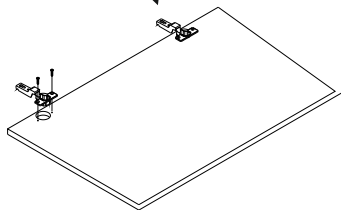
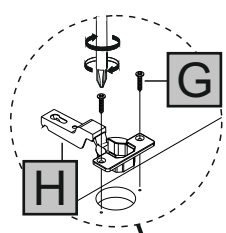

10

