

TeleSAFE XLN

EN 1004-1:2020

EN 1004-2:2021



202306-IE-1231

EN Assembly Guide
TR Montaj Kilavuzu
DE Montageanleitung
ES Guía de Montaje
FR Guide d'Assemblage
RU Руководство по сборке

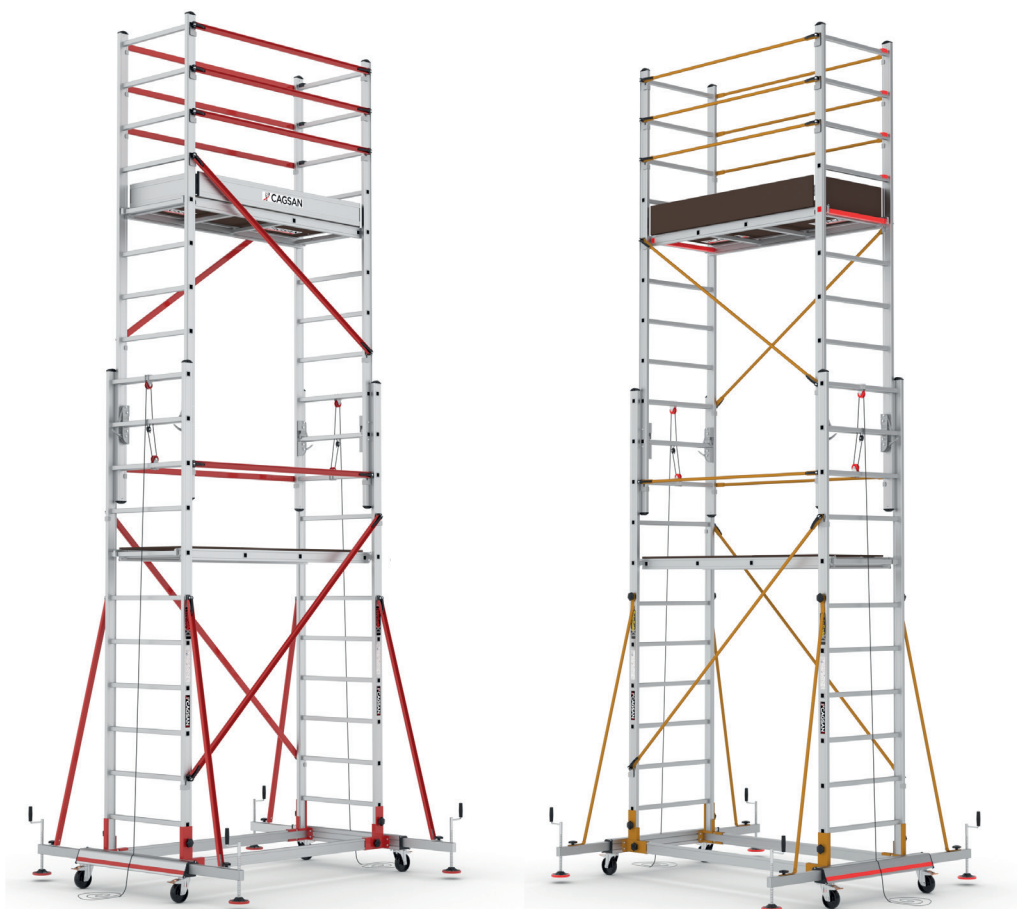

 **CAGSAN**
www.cagsanmerdiven.com

EN1004

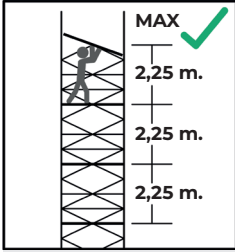

F. 1

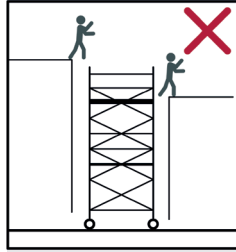

F. 2

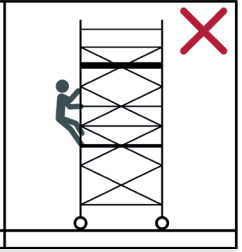
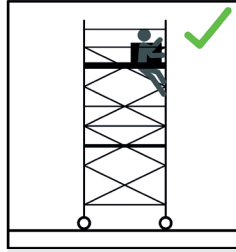

F. 3



F. 4

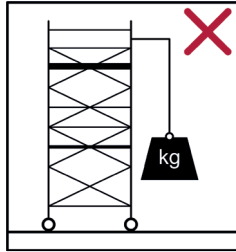

F. 5

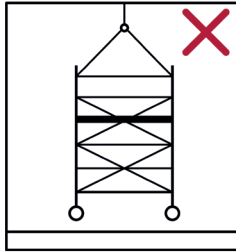

F. 6

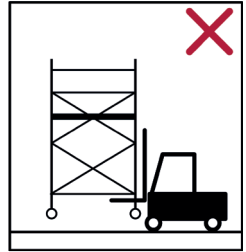

F. 7

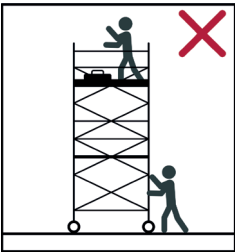

F. 8

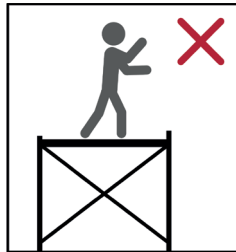

F. 9

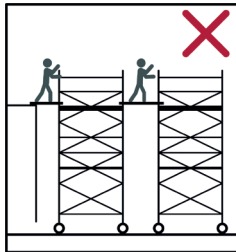

F. 10

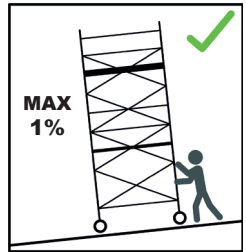

F. 11

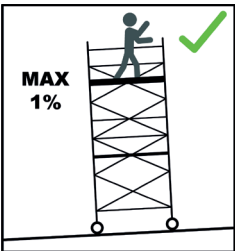

F. 12

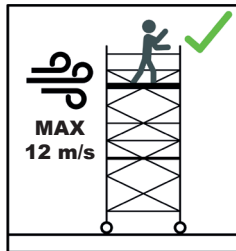

F. 13

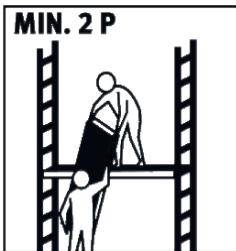

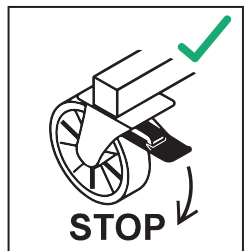

F. 14

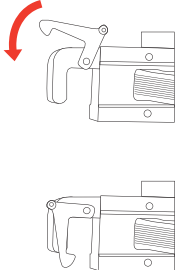
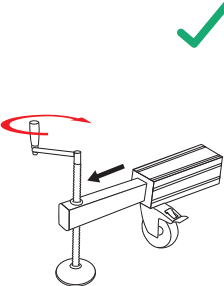
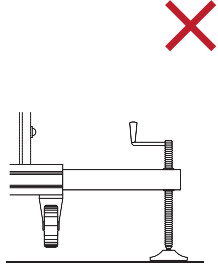
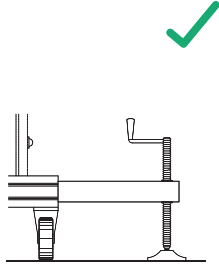
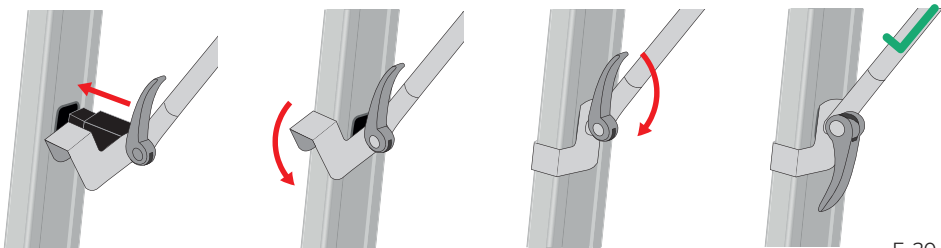
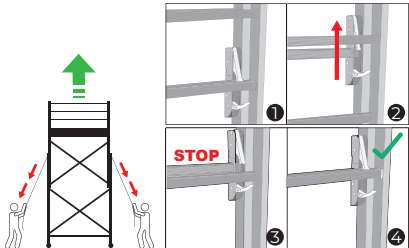
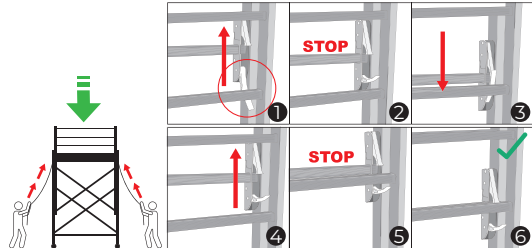

F. 15

EN1004

| | | | |
|--|--|---|---|
|  <p>F. 16</p> |  <p>F. 17</p> |  <p>F. 18</p> |  <p>F. 19</p> |
|  <p>F. 20</p> | | | |
|  <p>F.21</p> | |  <p>F.22</p> | |
|  <p>F. 23</p> | | | |

TELESAFE S006_XLN

- | | | | | | |
|----|------------|----|--------------|----|--------------|
| 3 | S006XLMTK | 11 | PLT155x60 | 18 | Q205075 |
| 6 | DA040506XL | 14 | AKS000000003 | 20 | Q248075 |
| 9 | 75251900 | 15 | TEK45678XL | 22 | DBR110001868 |
| 12 | PLT170x60 | 16 | Q171075 | | |

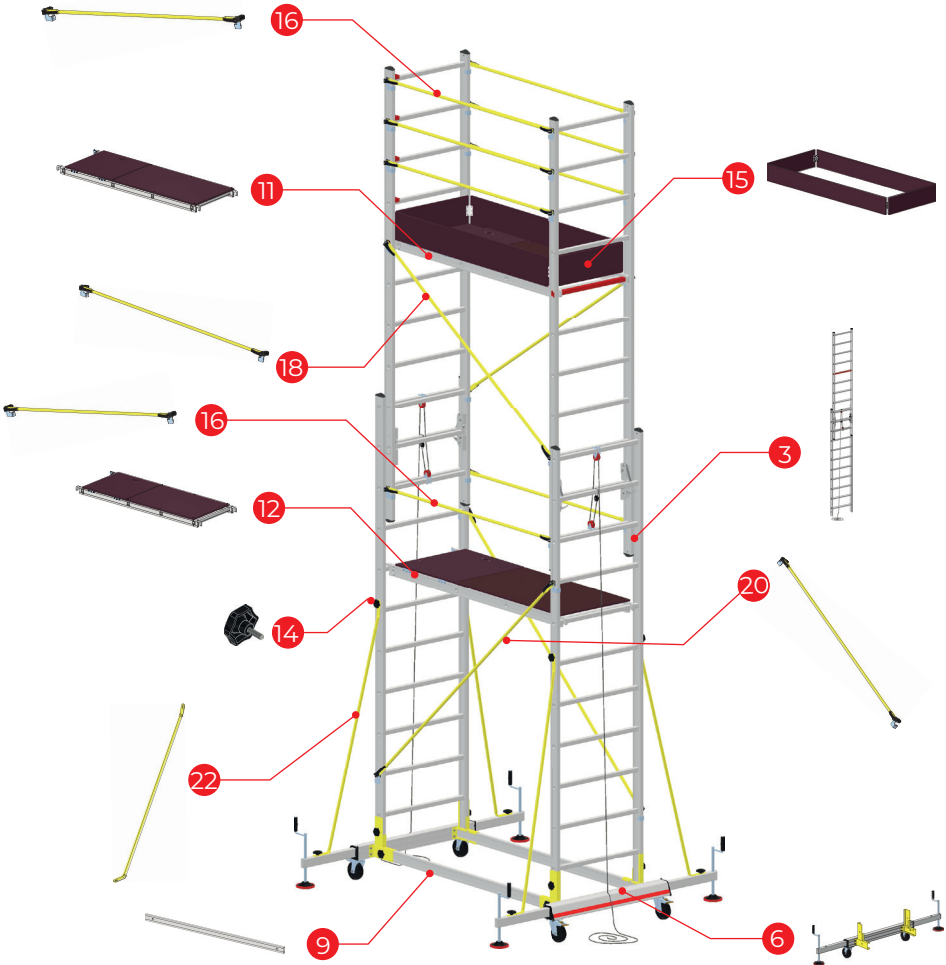

TELESAFE S006_XLN_PR

3 S006XLMTK

6 DA040506XL

9 75251900

12 PLT170x60

11 PLT155x60

14 AKS000000003

23 TEK45678XLAL

26 Q164075AL







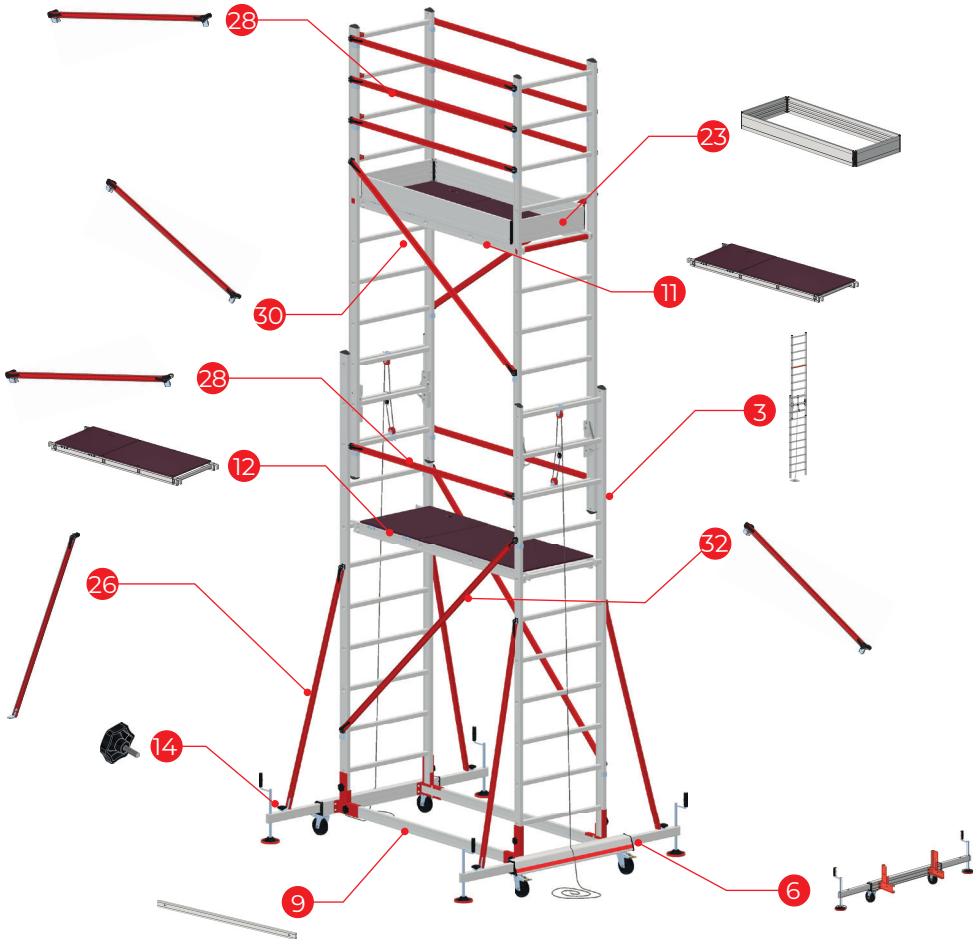

28 Q171075AL

30 Q205075AL



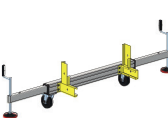
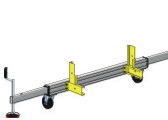
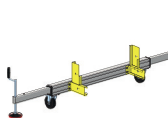

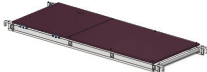
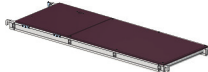
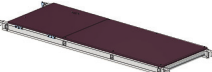



32 Q248075AL













TELESAFE XLN / XLN_PR

| | | | |
|---|---|---|---|
|  <p>S004XLMTK</p> <p>TR 8 bas, sürgülü merdiven EN 8 steps extension ladder RU 8-ступенчатая раздвижная лестница FR Echelle à coulisse 8 marches DE 8 Stufen Verlängerungsleiter ES Escalera extensible de 8 peldaños</p> |  <p>S005XLMTK</p> <p>TR 10 bas, sürgülü merdiven EN 10 steps extension ladder RU 10-ступенчатая раздвижная лестница FR Echelle à coulisse 10 marches DE 10 Stufen Verlängerungsleiter ES Escalera extensible de 10 peldaños</p> |  <p>S006XLMTK</p> <p>TR 11 bas, sürgülü merdiven EN 11 steps extension ladder RU 11-ступенчатая раздвижная лестница FR Echelle à coulisse 11 marches DE 11 Stufen Verlängerungsleiter ES Escalera extensible de 11 peldaños</p> |  <p>S007XLMTK</p> <p>TR 13 bas, sürgülü merdiven EN 13 steps extension ladder RU 13-ступенчатая раздвижная лестница FR Echelle à coulisse 13 marches DE 13 Stufen Verlängerungsleiter ES Escalera extensible de 13 peldaños</p> |
|  <p>S008XLMTK</p> <p>TR 15 bas, sürgülü merdiven EN 15 steps extension ladder RU 15-ступенчатая раздвижная лестница FR Echelle à coulisse 15 marches DE 15 Stufen Verlängerungsleiter ES Escalera extensible de 15 peldaños</p> |  <p>DA040506XL</p> <p>TR Denge ayağı 1220mm. EN Wheels and Stabilizer RU Колеса и стабилизатор FR Roues et stabilisateur DE Räder und Stabilisator ES Ruedas y estabilizador</p> |  <p>DA07XL</p> <p>TR Denge ayağı 1480mm. EN Wheels and Stabilizer RU Колеса и стабилизатор FR Roues et stabilisateur DE Räder und Stabilisator ES Ruedas y estabilizador</p> |  <p>DA08XL</p> <p>TR Denge ayağı 1540mm. EN Wheels and Stabilizer RU Колеса и стабилизатор FR Roues et stabilisateur DE Räder und Stabilisator ES Ruedas y estabilizador</p> |
|  <p>75251900</p> <p>TR Ara kayıt profili 1900mm. EN Connecting Profile RU Соединяющий профиль FR Profil de connexion DE Verbindungsprofil ES Perfil de conexión</p> |  <p>75251950</p> <p>TR Ara kayıt profili 1950mm. EN Connecting Profile RU Соединяющий профиль FR Profil de connexion DE Verbindungsprofil ES Perfil de conexión</p> |  <p>PLT155x60</p> <p>TR Platform EN Platform RU Платформа FR Plate-forme DE Plattform ES Plataforma</p> |  <p>PLT170x60</p> <p>TR Platform EN Platform RU Платформа FR Plate-forme DE Plattform ES Plataforma</p> |
|  <p>PLT180x60</p> <p>TR Platform EN Platform RU Платформа FR Plate-forme DE Plattform ES Plataforma</p> |  <p>AKS00000003</p> <p>TR Bakalit EN Bakelite Bolt RU Бакелит FR Tête en bakélite gras DE Bakelitkopf fett ES Tornillo de baquelita</p> | | |

TELESAFE XLN

| | | | |
|--|---|--|--|
|  <p>TEK45678XL</p> <p>TR Tekmelik EN Toeboard RU Деревянный бортик FR Plinthe DE Fußbrett ES Rodapié</p> |  <p>Q171075</p> <p>TR Yatay bağlantı EN Horizontal braces RU Горизонтальные распорки FR Accolades horizontales DE Horizontale Klammern ES Tirantes horizontales</p> |  <p>Q1710100</p> <p>TR Yatay bağlantı EN Horizontal braces RU Горизонтальные распорки FR Accolades horizontales DE Horizontale Klammern ES Tirantes horizontales</p> |  <p>Q205075</p> <p>TR Çapraz bağlantı EN Diagonal Braces RU Диагональные скобки FR Bretelles diagonales DE Diagonale Klammern ES Tirantes diagonales</p> |
|  <p>Q2050100</p> <p>TR Çapraz bağlantı EN Diagonal Braces RU Диагональные скобки FR Bretelles diagonales DE Diagonale Klammern ES Tirantes diagonales</p> |  <p>Q248075</p> <p>TR Çapraz bağlantı EN Diagonal Braces RU Диагональные скобки FR Bretelles diagonales DE Diagonale Klammern ES Tirantes diagonales</p> |  <p>Q2500100</p> <p>TR Çapraz bağlantı EN Diagonal Braces RU Диагональные скобки FR Bretelles diagonales DE Diagonale Klammern ES Tirantes diagonales</p> |  <p>DBR110001860</p> <p>TR Payanda EN Stabiliser RU Стабилизатор FR Stabilisateur DE Stabilisator ES Estabilizador</p> |











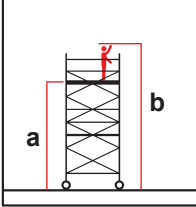















TELESAFE XLN PREMIUM

| | | | |
|--|---|---|--|
|  <p>TEK45678XLAL</p> |  <p>Q161075AL</p> |  <p>Q1620100AL</p> |  <p>Q164075AL</p> |
| <p>TR Alüminyum tekmelik EN Aluminum toeboard RU Алюминевый бортик FR Plinthe en aluminium DE Aluminium-Fußleiste ES Rodapié de aluminio</p> | <p>TR Payanda EN Stabiliser RU Стабилизатор FR Stabilisateur DE Stabilisator ES Estabilizador</p> | <p>TR Payanda EN Stabiliser RU Стабилизатор FR Stabilisateur DE Stabilisator ES Estabilizador</p> | <p>TR Payanda EN Stabiliser RU Стабилизатор FR Stabilisateur DE Stabilisator ES Estabilizador</p> |
|  <p>Q165575AL</p> |  <p>Q171075AL</p> |  <p>Q1710100AL</p> |  <p>Q205075AL</p> |
| <p>TR Payanda EN Stabiliser RU Стабилизатор FR Stabilisateur DE Stabilisator ES Estabilizador</p> | <p>TR Yatay bağlantı EN Horizontal braces RU Горизонтальные распорки FR Accolades horizontales DE Horizontale Klammern ES Tirantes horizontales</p> | <p>TR Yatay bağlantı EN Horizontal braces RU Горизонтальные распорки FR Accolades horizontales DE Horizontale Klammern ES Tirantes horizontales</p> | <p>TR Çapraz bağlantı EN Diagonal Braces RU Диагональные скобки FR Bretelles diagonales DE Diagonale Klammern ES Tirantes diagonales</p> |
|  <p>Q2500100AL</p> |  <p>Q248075AL</p> |  <p>Q2050100AL</p> | |
| <p>TR Çapraz bağlantı EN Diagonal Braces RU Диагональные скобки FR Bretelles diagonales DE Diagonale Klammern ES Tirantes diagonales</p> | <p>TR Çapraz bağlantı EN Diagonal Braces RU Диагональные скобки FR Bretelles diagonales DE Diagonale Klammern ES Tirantes diagonales</p> | <p>TR Çapraz bağlantı EN Diagonal Braces RU Диагональные скобки FR Bretelles diagonales DE Diagonale Klammern ES Tirantes diagonales</p> | |

TELESAFE XLN

| | | | S004_XLN | S005_XLN | S006_XLN | S007_XLN | S008_XLN | |
|-----------------|--------------|--------------------------------------|----------|--------------|---------------|---------------|---------------|---------------|
| | | | a | 2,75m. | 3,83m. | 4,42m. | 5,23m. | 6,05m. |
| | | | b | 4,75m. | 5,83m. | 6,42m. | 7,23m. | 8,05m. |
| Kg. | 13 | S004XLMTK 130x2300x750mm. | | 2 | - | - | - | - |
| | 16 | S005XLMTK 130x2800x750mm. | | - | 2 | - | - | - |
| | 17,8 | S006XLMTK 130x3100x750mm. | | - | - | 2 | - | - |
| | 19,8 | S007XLMTK 130x3650x750mm. | | - | - | - | 2 | - |
| | 28 | S008XLMTK 170x4200x750mm. | | - | - | - | - | 2 |
| | 27 | DA040506XL 1196x372x453mm. | | 1 | 1 | 1 | - | - |
| | 28,6 | DA07XL 1396x372x453mm. | | - | - | - | 1 | - |
| | 28,8 | DA08XL 1396x372x453mm. | | - | - | - | - | 1 |
| | 1,2 | 75251900 1900x25x75mm. | | 2 | 2 | 2 | 2 | - |
| | 1,4 | 75251950 1950x25x75mm. | | - | - | - | - | 2 |
| | 13,2 | PLT155x60 1750x600x75mm. | | 1 | 1 | 1 | 2 | 2 |
| | 13,8 | PLT170x60 1854x600x75mm. | | - | 1 | 1 | - | - |
| | 14 | PLT180x60 1876x600x75mm. | | - | - | - | - | 1 |
| | 8 | TEK45678XL 2200x200x50mm. | | 1 | 1 | 1 | 1 | 1 |
| | 1,4 | Q171075 1730x100x60mm. | | 6 | 8 | 8 | 8 | - |
| | 1,47 | Q1710100 1730x100x60mm. | | - | - | - | - | 8 |
| | 1,6 | Q205075 2050x100x60mm. | | 2 | 2 | 2 | 2 | - |
| | 1,7 | Q2050100 2050x100x60mm. | | - | - | - | - | 2 |
| | 2 | Q248075 2480x100x60mm. | | 2 | 2 | 2 | 2 | - |
| | 2,02 | Q2500100 2500x100x60mm. | | - | - | - | - | 4 |
| | 1,2 | DBR10001860 1860x150x30mm. | | 4 | 4 | 4 | 4 | 4 |
| | 0,042 | AKS000000003 60x55x60mm. | | 16 | 16 | 16 | 16 | 16 |
| TOTAL KG | | | | 98 kg | 121 kg | 124 kg | 130 kg | 165 kg |

TELESAFE XLN PREMIUM

| | | | S004 XLN_PR | S005 XLN_PR | S006 XLN_PR | S007 XLN_PR | S008 XLN_PR |
|---|---------------------------------------|---|----------------|----------------|----------------|----------------|----------------|
|  | | a | 2,75m. | 3,83m. | 4,42m. | 5,23m. | 6,05m. |
| | | b | 4,75m. | 5,83m. | 6,42m. | 7,23m. | 8,05m. |
| Kg. 13 | S004XLMTK 130x230x750mm. |  | 2 | - | - | - | - |
| 16 | S005XLMTK 130x280x750mm. |  | - | 2 | - | - | - |
| 17,8 | S006XLMTK 130x310x750mm. |  | - | - | 2 | - | - |
| 19,8 | S007XLMTK 130x365x750mm. |  | - | - | - | 2 | - |
| 28 | S008XLMTK 170x420x750mm. |  | - | - | - | - | 2 |
| 27 | DA040506XL 1196x372x453mm. |  | 1 | 1 | 1 | - | - |
| 28,6 | DA07XL 1396x372x453mm. |  | - | - | - | 1 | - |
| 28,8 | DA08XL 1396x372x453mm. |  | - | - | - | - | 1 |
| 1,2 | 75251900 1900x25x75mm. |  | 2 | 2 | 2 | 2 | - |
| 1,4 | 75251950 1950x25x75mm. |  | - | - | - | - | 2 |
| 13,2 | PLT155x60 1750x600x75mm. |  | 1 | 1 | 1 | 2 | 2 |
| 13,8 | PLT170x60 1854x600x75mm. |  | - | 1 | 1 | - | - |
| 14 | PLT180x60 1876x600x75mm. |  | - | - | - | - | 1 |
| 5,7 | TEK45678XLAL 2246x160x60mm. |  | 1 | 1 | 1 | 1 | 1 |
| 1,25 | Q161075AL 1610x100x42mm. |  | - | 4 | - | - | - |
| 1,27 | Q1620100AL 1620x100x42mm. |  | - | - | - | - | 4 |
| 1,27 | Q164075AL 1640x100x42mm. |  | - | - | 4 | 4 | - |
| 1,28 | Q165575AL 1655x100x42mm. |  | 4 | - | - | - | - |
| 1,37 | Q171075AL 1710x100x60mm. |  | 6 | 8 | 8 | 8 | - |
| 1,40 | Q1710100AL 1710x100x60mm. |  | - | - | - | - | 8 |
| 1,58 | Q205075AL 2050x100x60mm. |  | 2 | 2 | 2 | 2 | - |
| 1,60 | Q2050100AL 2050x100x60mm. |  | - | - | - | - | 2 |
| 1,83 | Q248075AL 2480x100x60mm. |  | 2 | 2 | 2 | 2 | - |
| 1,86 | Q2500100AL 2500x100x60mm. |  | - | - | - | - | 4 |
| 0,042 | AKS000000003 60x35x60mm. |  | 12 | 12 | 12 | 12 | 12 |
| TOTAL KG | | | 95 kg | 117 kg | 121 kg | 126 kg | 161 kg |

TELESAFE S004_XLN

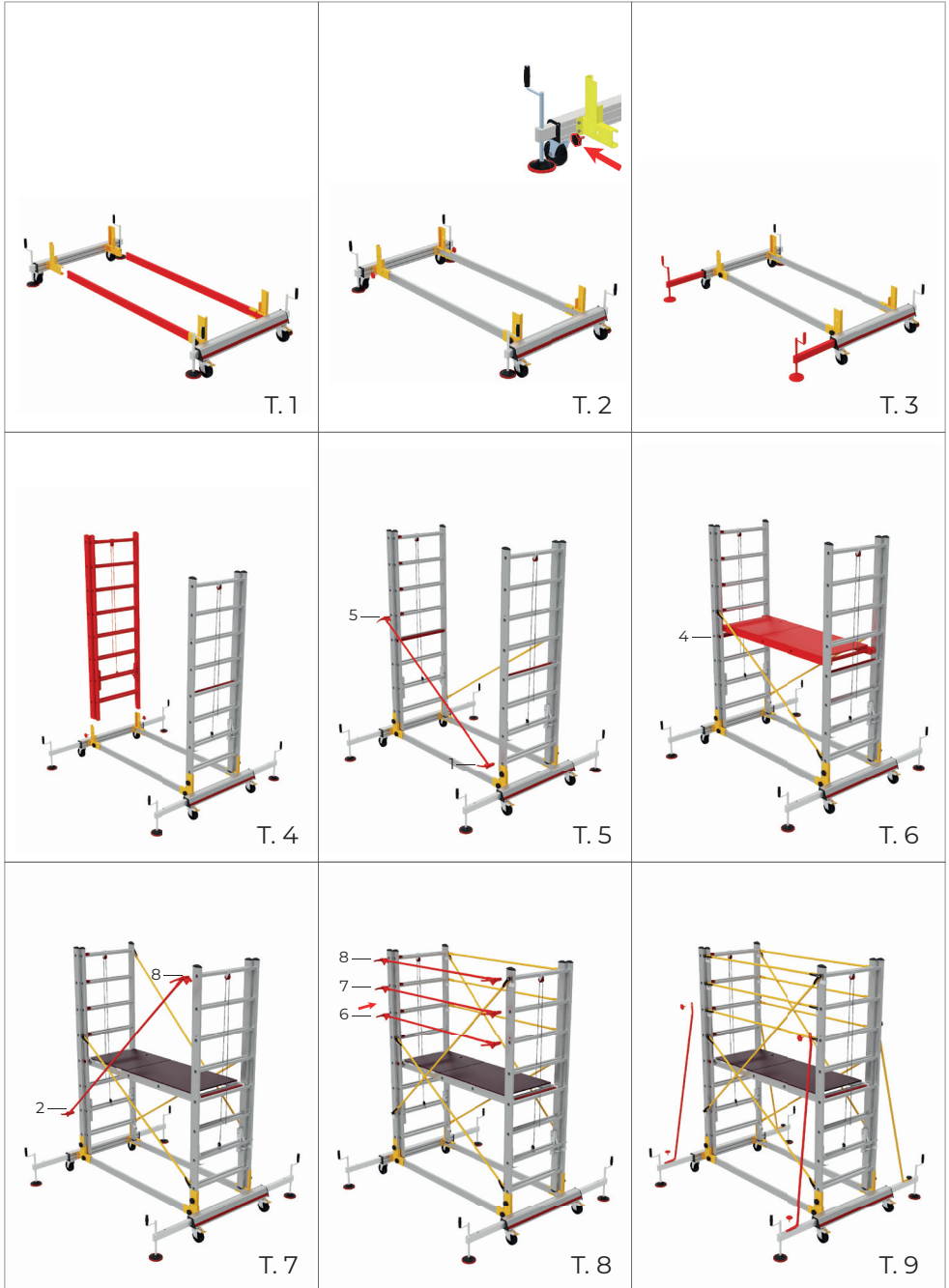

TELESAFE S004_XLN

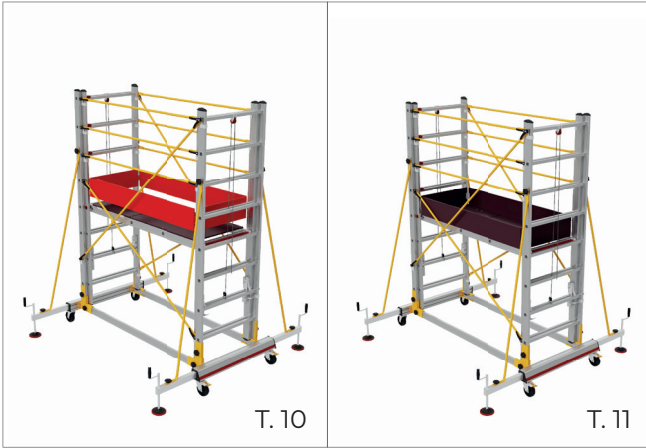

S004_XLN

TELESAFE XLN

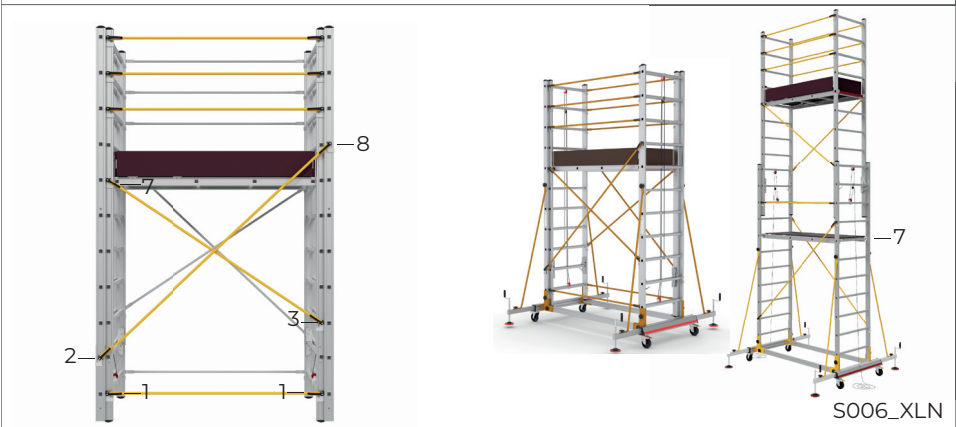
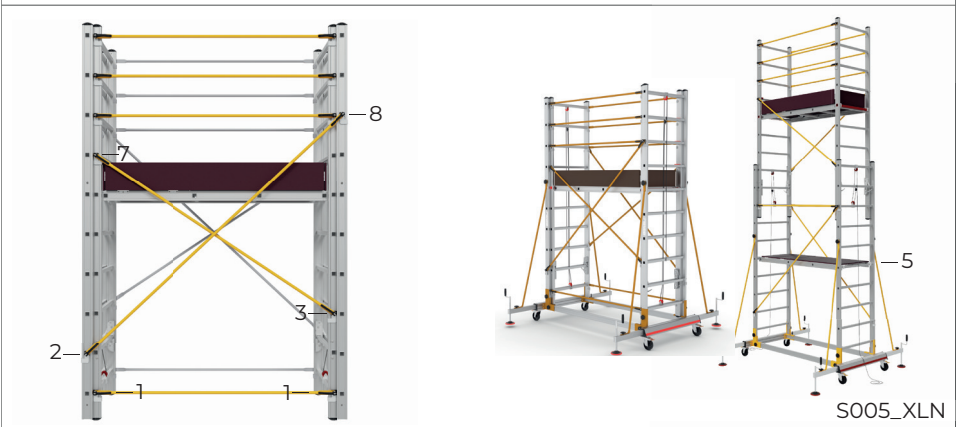
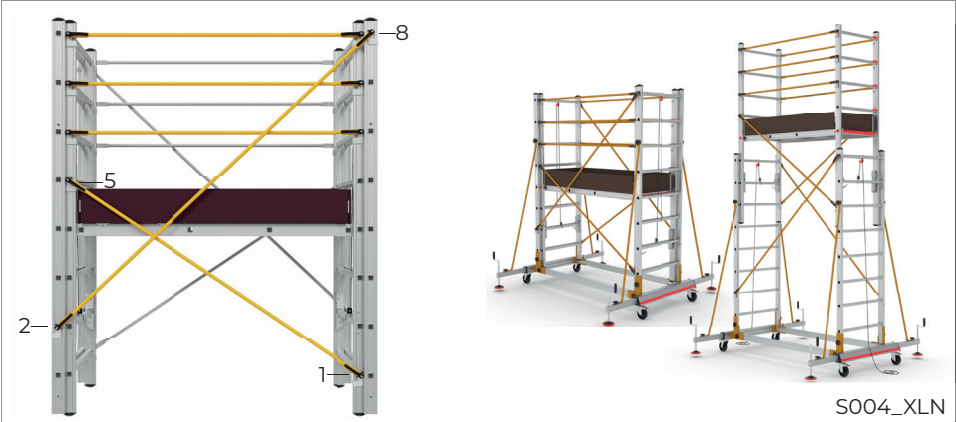

TELESAFE XLN

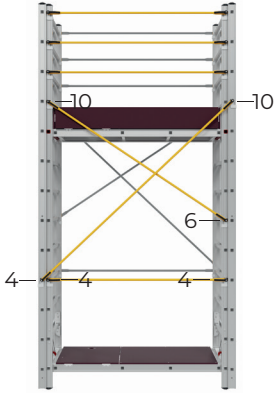

S007_XLN

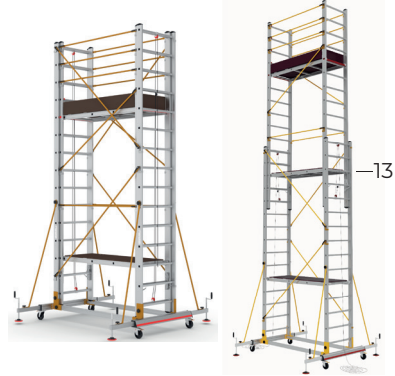
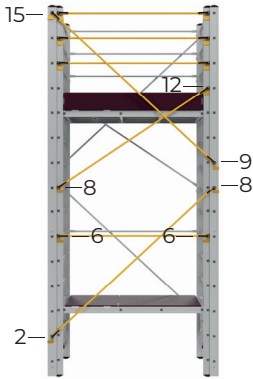

S008_XLN

TELESAFE XLN_PR

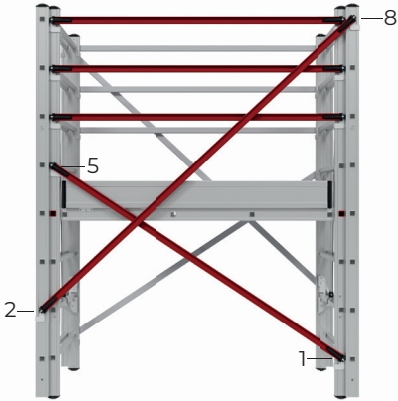

S004_XLN_PR

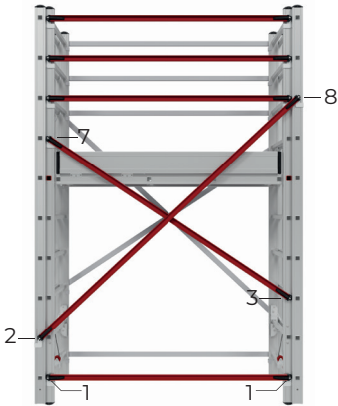

S005_XLN_PR

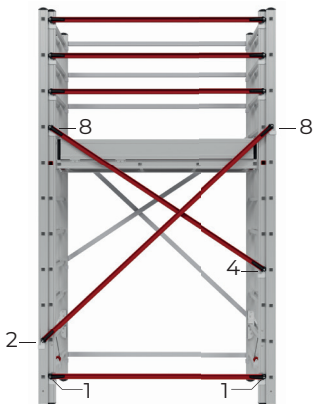

S006_XLN_PR

TELESAFE XLN_PR

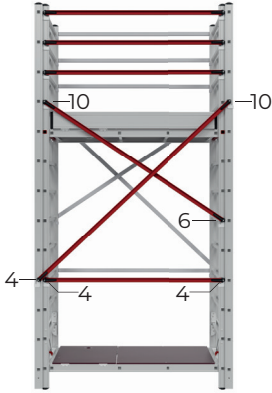

S007_XLN_PR

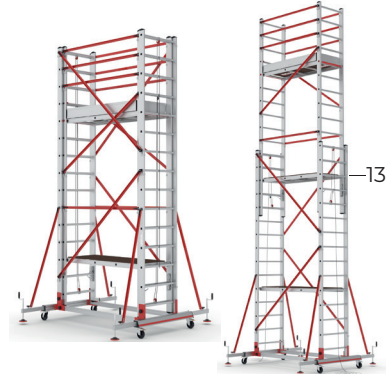
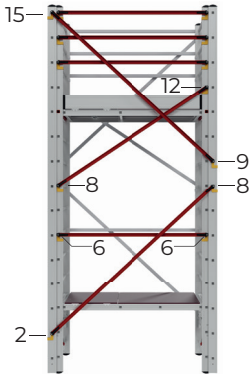

S008_XLN_PR

EN 1004

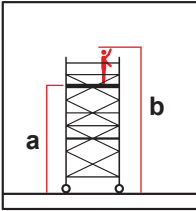

| | S004_XLN | S005_XLN | S006_XLN | S007_XLN | S008_XLN |
|----------|----------|----------|----------|----------|----------|
| a | 2,75m. | 3,83m. | 4,42m. | 5,23m. | 6,05m. |
| b | 4,75m. | 5,83m. | 6,42m. | 7,23m. | 8,05m. |

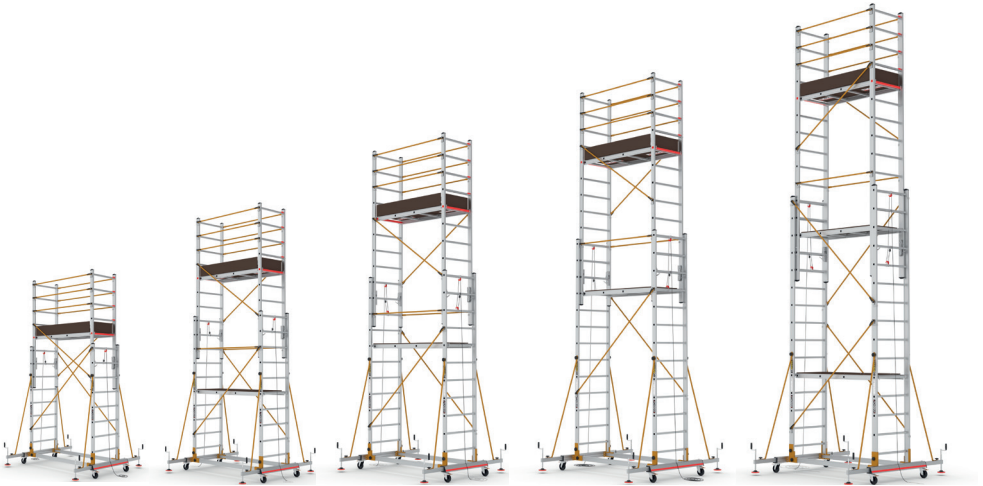

S004_XLN

S005_XLN

S006_XLN

S007_XLN

S008_XLN

EN 1004

| | S004 XLN_PR | S005 XLN_PR | S006 XLN_PR | S007 XLN_PR | S008 XLN_PR |
|----------|----------------|----------------|----------------|----------------|----------------|
| a | 2,75m. | 3,83m. | 4,42m. | 5,23m. | 6,05m. |
| b | 4,75m. | 5,83m. | 6,42m. | 7,23m. | 8,05m. |

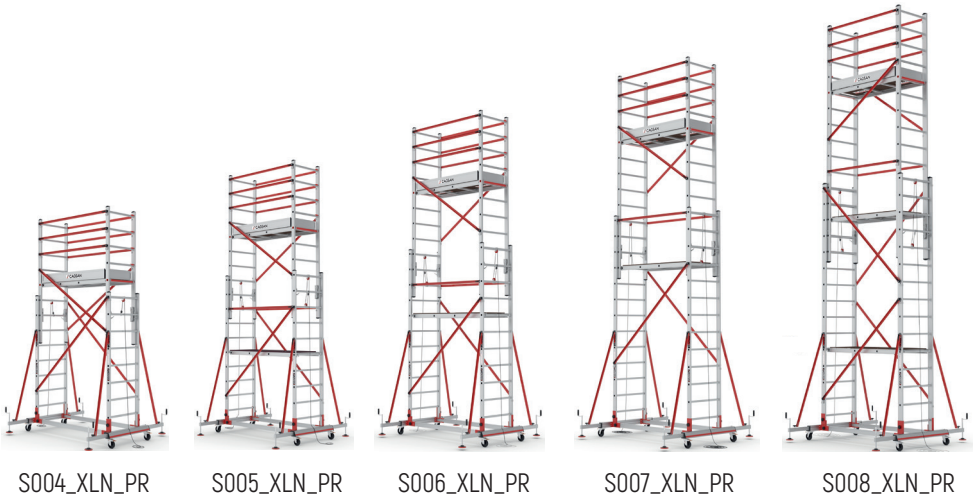
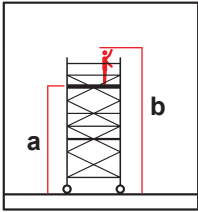

Hazırlayan: Çağsan Merdiven ve Eriřim Ekipmanları San. Tic. Ltd. řti.

©2023 Tüm hakları saklıdır. Çağsan Merdiven'in yazılı izni olmaksızın bu dokümanın tamamı veya belli bir bölümü hiçbir şekilde basılı veya herhangi diđer bir elektronik ortamda kullanılmaz, çoğaltılamaz ve kopyalanamaz.

Prepared by: Çağsan Merdiven ve Eriřim Ekipmanları San.Tic.Ltd.řti.

©2023 All rights reserved. Without the written consent of Çağsan Merdiven, all or any part of this document may be printed or copied.

Cagsan Merdiven ve Erisim Ekipmanlari San.Tic.Ltd.Sti.

Gebze Factory:

Dilovasi Organize Sanayi Bolgesi 3.Kisim, Meric Cad. No: 1 Muallim Koyu, Gebze, Kocaeli/TURKEY

Balıkesir Factory:

Gaziosmanpasa OSB Mah. 17. Cad. No:11A Altieylul, Balıkesir/TURKEY

T: +90 262 759 18 08 F: +90 262 759 18 78

info@cagsanmerdiven.com.tr
www.cagsanmerdiven.com



ÇAĞSAN MERDİVEN VE ERIŐİM EKİPMANLARI SAN.TİC.LTD.ŐTİ.

GEBZE FABRİKA: Dilovası OSB, 3. Kısım, Meriç Cad. No:1 Muallim Köyü, Gebze-KOCAELİ/TÜRKİYE

Tel: +90 262 759 18 08 **Fax:** +90 262 759 18 78

BALIKESİR FABRİKA: Balıkesir OSB, Gaziosmanpaőa OSB Mah. 17. Cad. No: 11A Altieylül - BALIKESİR / TÜRKİYE

Tel: +90 266 244 43 40 **e-posta:** info@cagsanmerdiven.com.tr